

## N-Channel Super Junction Power MOSFET III

### General Description

The series of devices use advanced trench gate super junction technology and design to provide excellent  $R_{DS(ON)}$  with low gate charge. This super junction MOSFET fits the industry's AC-DC SMPS requirements for PFC, AC/DC power conversion, and industrial power applications.

### Features

- New technology for high voltage device
- Low on-resistance and low conduction losses
- Small package
- Ultra Low Gate Charge cause lower driving requirements
- 100% Avalanche Tested
- ROHS compliant

### Application

- Power factor correction (PFC)
- Switched mode power supplies (SMPS)
- Uninterruptible Power Supply (UPS)

$V_{DS}$	650	V
$R_{DS(ON) MAX}$	190	m $\Omega$
$I_D$	21	A

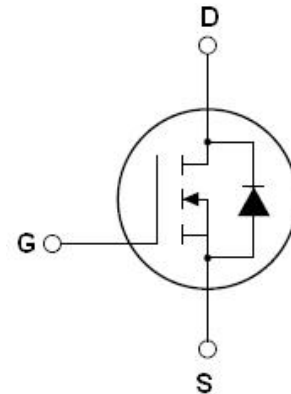

Schematic diagram

### Package Marking And Ordering Information

Device	Device Package	Marking
NCE65T180	TO-220	NCE65T180
NCE65T180F	TO-220F	NCE65T180F
NCE65T180D	TO-263	NCE65T180D

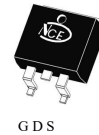

GDS

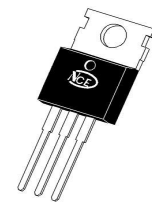

GDS

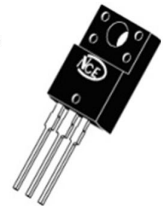

GDS

TO-263

TO-220

TO-220F

Table 1. Absolute Maximum Ratings ( $T_C=25^\circ\text{C}$ )

Parameter	Symbol	NCE65T180 NCE65T180D	NCE65T180F	Unit
Drain-Source Voltage ( $V_{GS}=0V$ )	$V_{DS}$	650		V
Gate-Source Voltage ( $V_{DS}=0V$ ), AC ( $f>1$ Hz)	$V_{GS}$	$\pm 30$		V
Continuous Drain Current at $T_C=25^\circ\text{C}$	$I_{D(DC)}$	21	21*	A
Continuous Drain Current at $T_C=100^\circ\text{C}$	$I_{D(DC)}$	13.2	13.2*	A
Pulsed drain current (Note 1)	$I_{DM(pluse)}$	84	84*	A
Maximum Power Dissipation ( $T_C=25^\circ\text{C}$ )	$P_D$	188	33.8	W
Derate above $25^\circ\text{C}$		1.5	0.27	W/ $^\circ\text{C}$
Single pulse avalanche energy (Note 2)	$E_{AS}$	441		mJ
Avalanche current (Note 1)	$I_{AR}$	10.5		A
Repetitive Avalanche energy, $t_{AR}$ limited by $T_{Jmax}$ (Note 1)	$E_{AR}$	0.7		mJ

Parameter	Symbol	NCE65T180 NCE65T180D	NCE65T180F	Unit
Drain Source voltage slope, $V_{DS} \leq 480V$ ,	dv/dt	50		V/ns
Reverse diode dv/dt, $V_{DS} \leq 480V, I_{SD} < I_D$	dv/dt	15		V/ns
Operating Junction and Storage Temperature Range	$T_J, T_{STG}$	-55...+150		°C

\* limited by maximum junction temperature

**Table 2. Thermal Characteristic**

Parameter	Symbol	NCE65T180 NCE65T180D	NCE65T180F	Unit
Thermal Resistance, Junction-to-Case (Maximum)	$R_{thJC}$	0.66	3.69	°C / W
Thermal Resistance, Junction-to-Ambient (Maximum)	$R_{thJA}$	62.5	80	°C / W

**Table 3. Electrical Characteristics (TA=25°C unless otherwise noted)**

Parameter	Symbol	Condition	Min	Typ	Max	Unit
<b>On/off states</b>						
Drain-Source Breakdown Voltage	$BV_{DSS}$	$V_{GS}=0V, I_D=250\mu A$	650			V
Zero Gate Voltage Drain Current( $T_C=25^\circ C$ )	$I_{DSS}$	$V_{DS}=650V, V_{GS}=0V$		0.05	1	$\mu A$
Zero Gate Voltage Drain Current( $T_C=125^\circ C$ )	$I_{DSS}$	$V_{DS}=650V, V_{GS}=0V$			100	$\mu A$
Gate-Body Leakage Current	$I_{GSS}$	$V_{GS}=\pm 20V, V_{DS}=0V$			$\pm 100$	nA
Gate Threshold Voltage	$V_{GS(th)}$	$V_{DS}=V_{GS}, I_D=250\mu A$	3	3.5	4	V
Drain-Source On-State Resistance	$R_{DS(ON)}$	$V_{GS}=10V, I_D=10.5A$		150	190	m $\Omega$
<b>Dynamic Characteristics</b>						
Forward Transconductance	$g_{FS}$	$V_{DS} = 20V, I_D = 10.5A$		16		S
Input Capacitance	$C_{iss}$	$V_{DS}=50V, V_{GS}=0V,$ $F=1.0MHz$		2250		PF
Output Capacitance	$C_{oss}$			83		PF
Reverse Transfer Capacitance	$C_{rss}$			1.6		PF
Total Gate Charge	$Q_g$	$V_{DS}=480V, I_D=21A,$ $V_{GS}=10V$		36		nC
Gate-Source Charge	$Q_{gs}$			14		nC
Gate-Drain Charge	$Q_{gd}$			8.5		nC
<b>Switching times</b>						
Turn-on Delay Time	$t_{d(on)}$	$V_{DD}=380V, I_D=11A,$ $R_G=4\Omega, V_{GS}=10V$		11		nS
Turn-on Rise Time	$t_r$			6		nS
Turn-Off Delay Time	$t_{d(off)}$			61		nS
Turn-Off Fall Time	$t_f$			4.5		nS
<b>Source- Drain Diode Characteristics</b>						
Source-drain current(Body Diode)	$I_{SD}$	$T_C=25^\circ C$			21	A
Pulsed Source-drain current(Body Diode)	$I_{SDM}$				84	A
Forward on voltage	$V_{SD}$	$T_J=25^\circ C, I_{SD}=21A, V_{GS}=0V$		0.9	1.3	V
Reverse Recovery Time	$t_{rr}$	$T_J=25^\circ C, I_F=21A, di/dt=100A/\mu s$		310		nS
Reverse Recovery Charge	$Q_{rr}$			5		$\mu C$
Peak Reverse Recovery Current	$I_{rrm}$			28		A

Notes 1. Repetitive Rating: Pulse width limited by maximum junction temperature

2.  $T_J=25^\circ C, V_{DD}=50V, V_G=10V, R_G=25\Omega$

## TYPICAL ELECTRICAL AND THERMAL CHARACTERISTICS (curves)

Figure1. Safe operating area for TO-220/TO-263

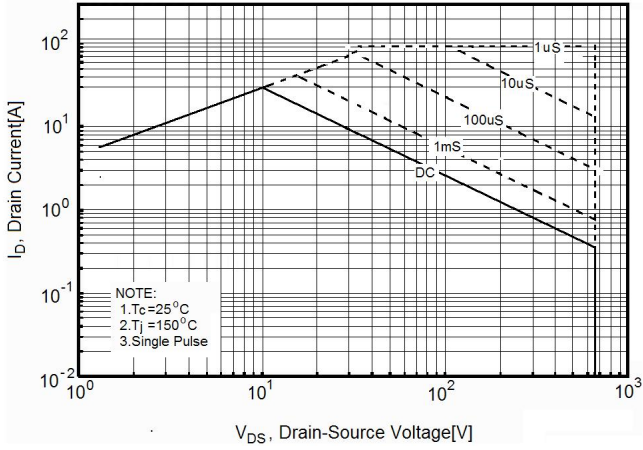

Figure2. Safe operating area for TO-220F

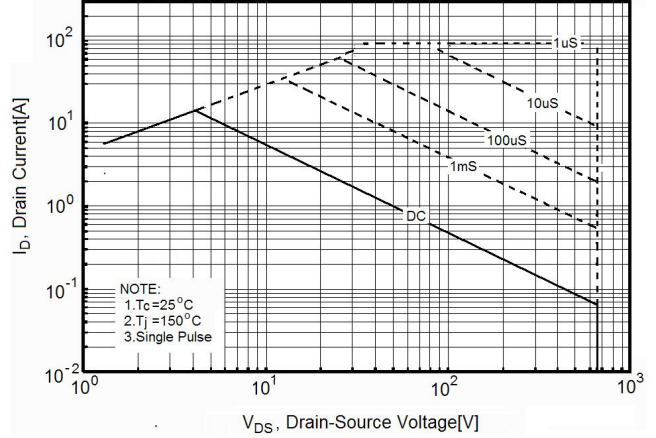

Figure3. Source-Drain Diode Forward Voltage

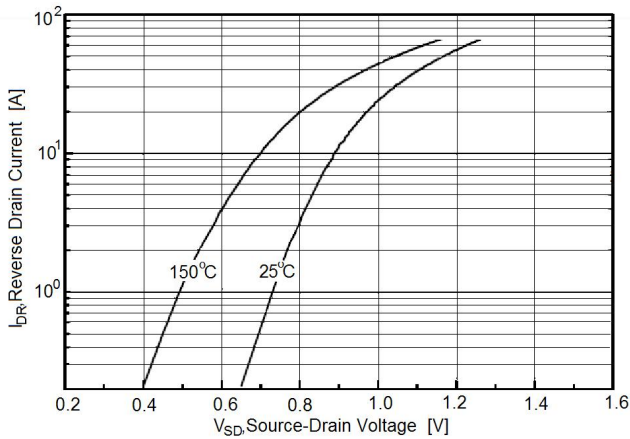

Figure4. Output characteristics

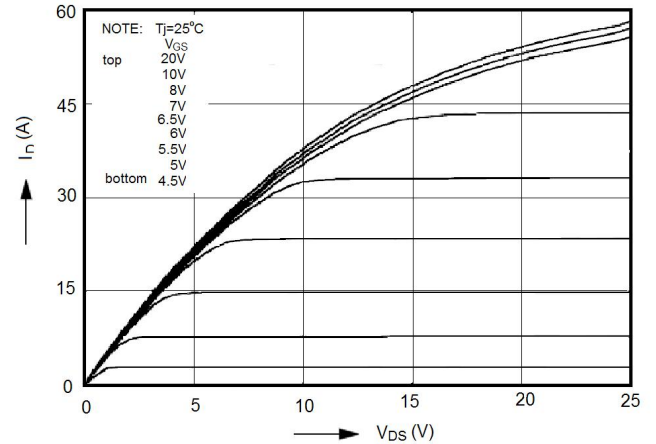

Figure5. Transfer characteristics

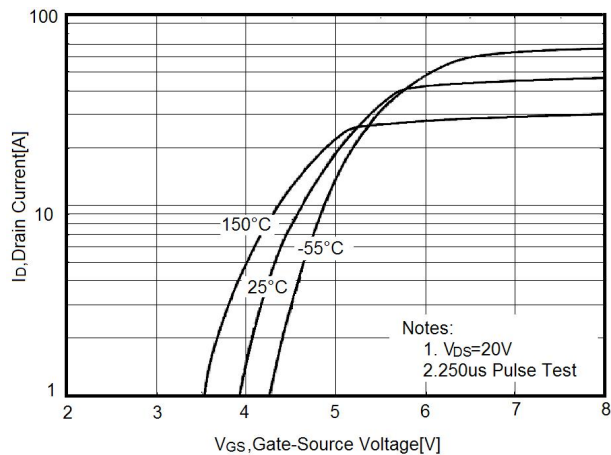
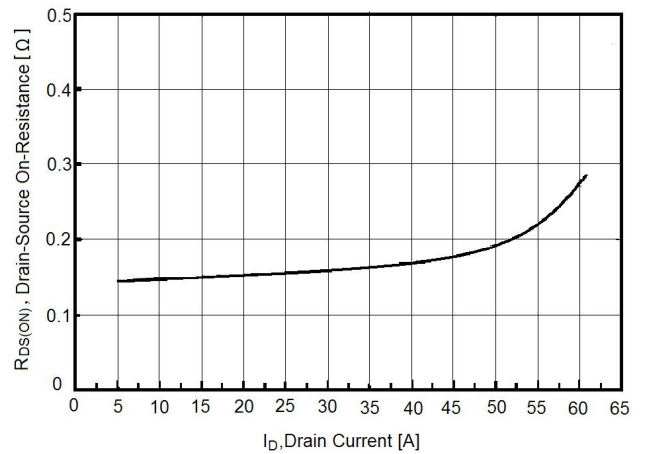
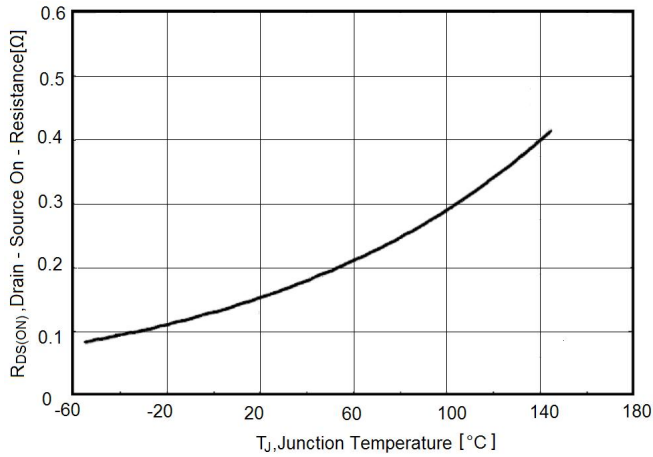

Figure6. Static drain-source on resistance



**Figure7.  $R_{DS(ON)}$  vs Junction Temperature**



**Figure8.  $BV_{DSS}$  vs Junction Temperature**

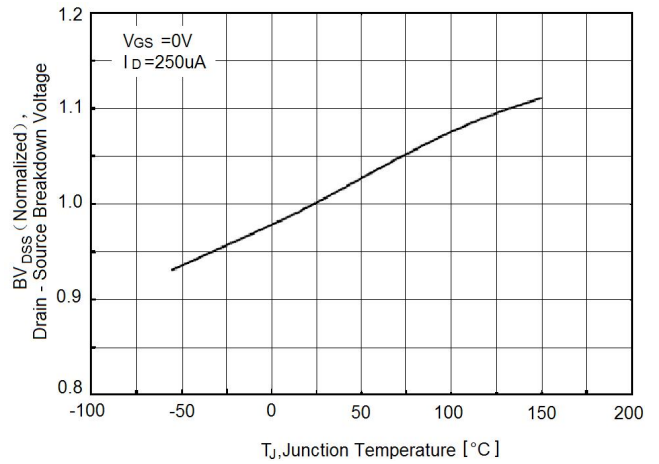

**Figure9. Maximum  $I_D$  vs Junction Temperature**

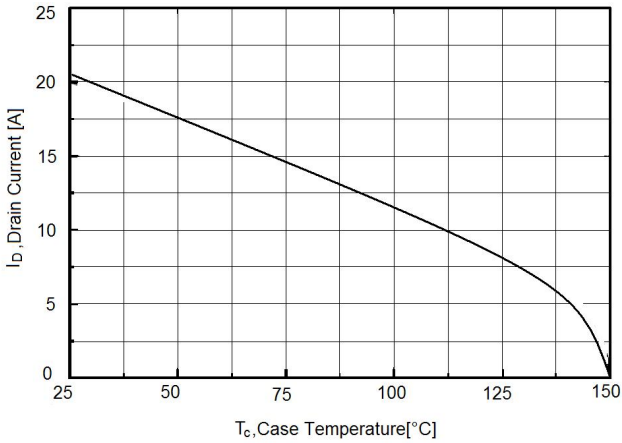

**Figure10. Transient Thermal Impedance for TO-220**

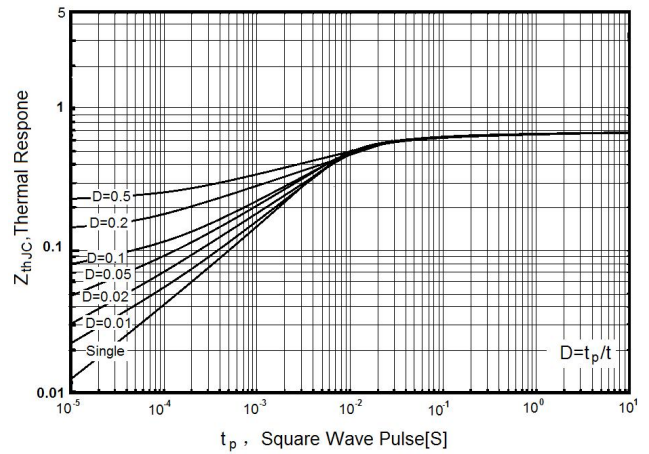

**Figure11. Transient Thermal Impedance for TO-220F**

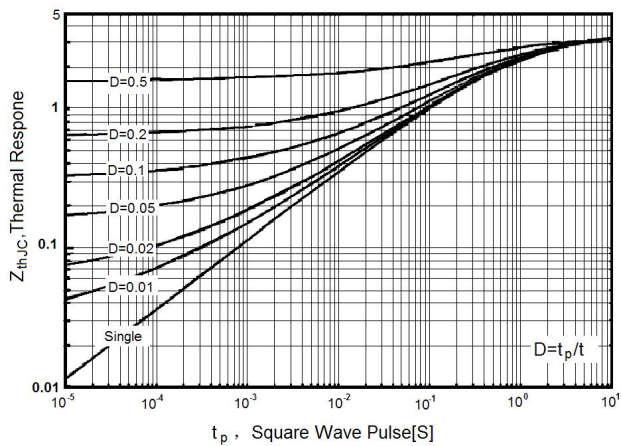

**Figure12. Gate charge waveforms**

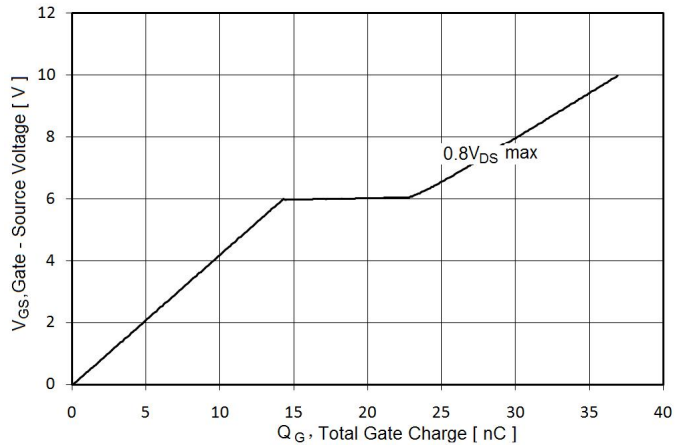
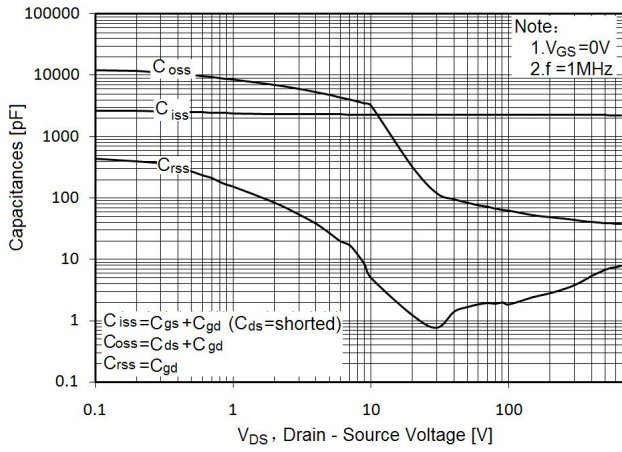
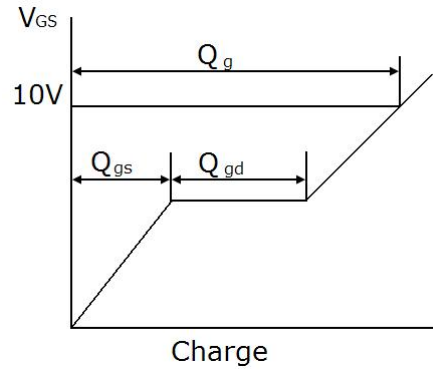
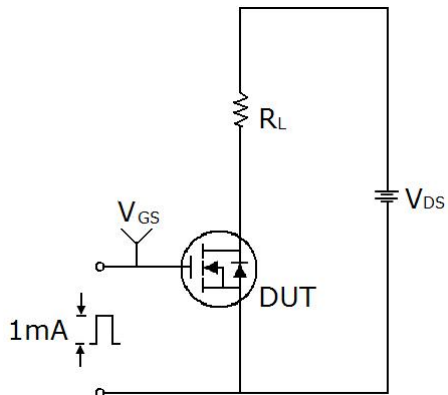

Figure13. Capacitance



## Test circuit

### 1) Gate charge test circuit & Waveform



### 2) Switch Time Test Circuit:

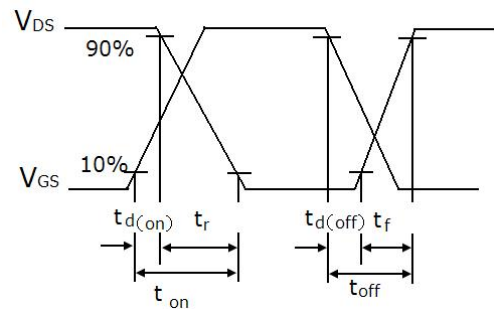
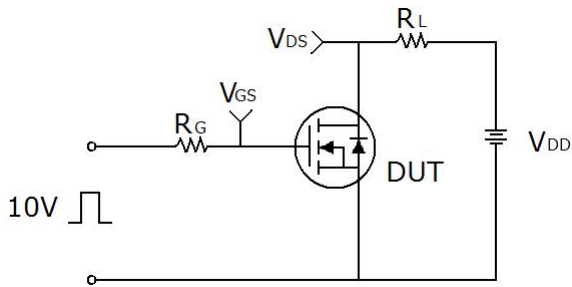

### 3) Unclamped Inductive Switching Test Circuit & Waveforms

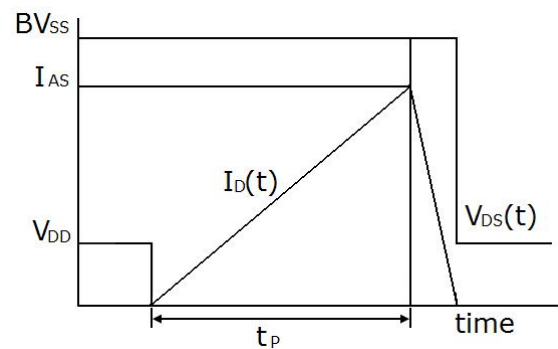
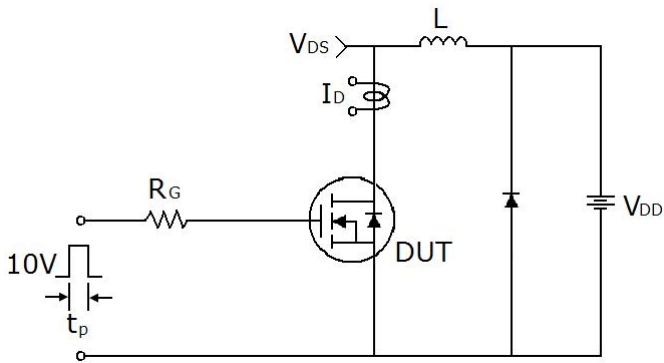

## TO-220-3L-C Package Information

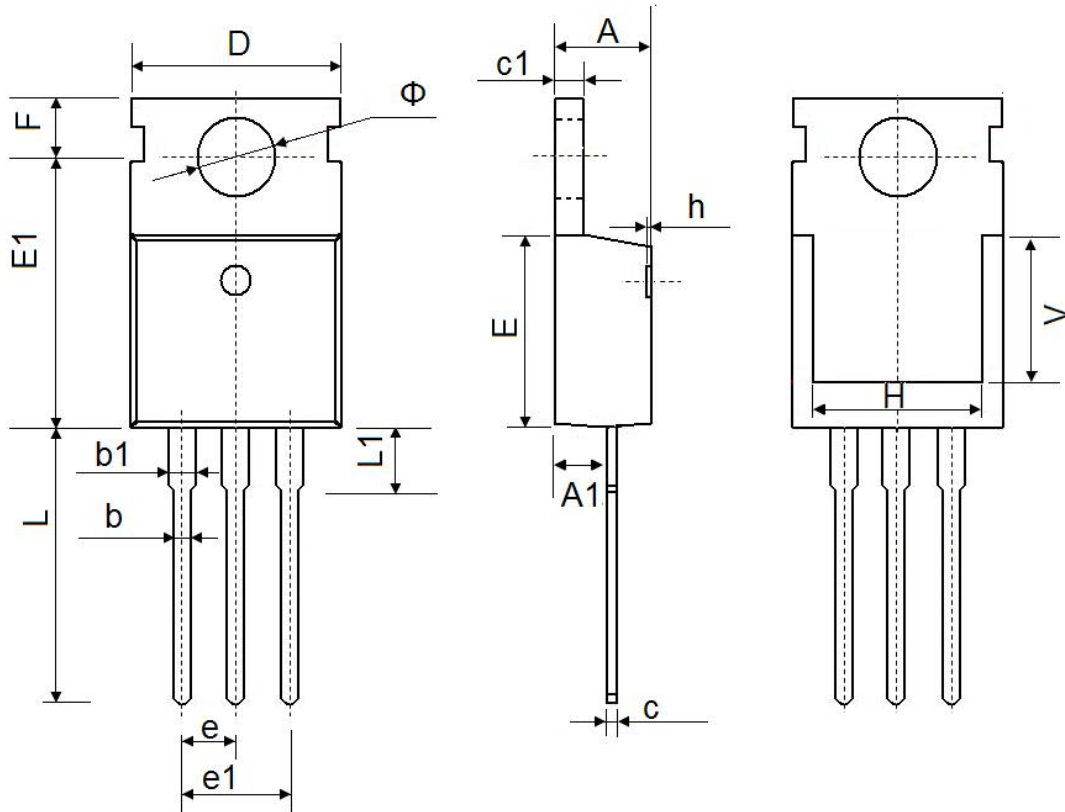

Symbol	Dimensions In Millimeters		Dimensions In Inches	
	Min.	Max.	Min.	Max.
A	4.400	4.600	0.173	0.181
A1	2.250	2.550	0.089	0.100
b	0.710	0.910	0.028	0.036
b1	1.170	1.370	0.046	0.054
c	0.330	0.650	0.013	0.026
c1	1.200	1.400	0.047	0.055
D	9.910	10.250	0.390	0.404
E	8.9500	9.750	0.352	0.384
E1	12.650	12.950	0.498	0.510
e	2.540 TYP.		0.100 TYP.	
e1	4.980	5.180	0.196	0.204
F	2.650	2.950	0.104	0.116
H	7.900	8.100	0.311	0.319
h	0.000	0.300	0.000	0.012
L	12.900	13.400	0.508	0.528
L1	2.850	3.250	0.112	0.128
V	7.500 REF.		0.295 REF.	
Φ	3.400	3.800	0.134	0.150

## TO-263 Package Information

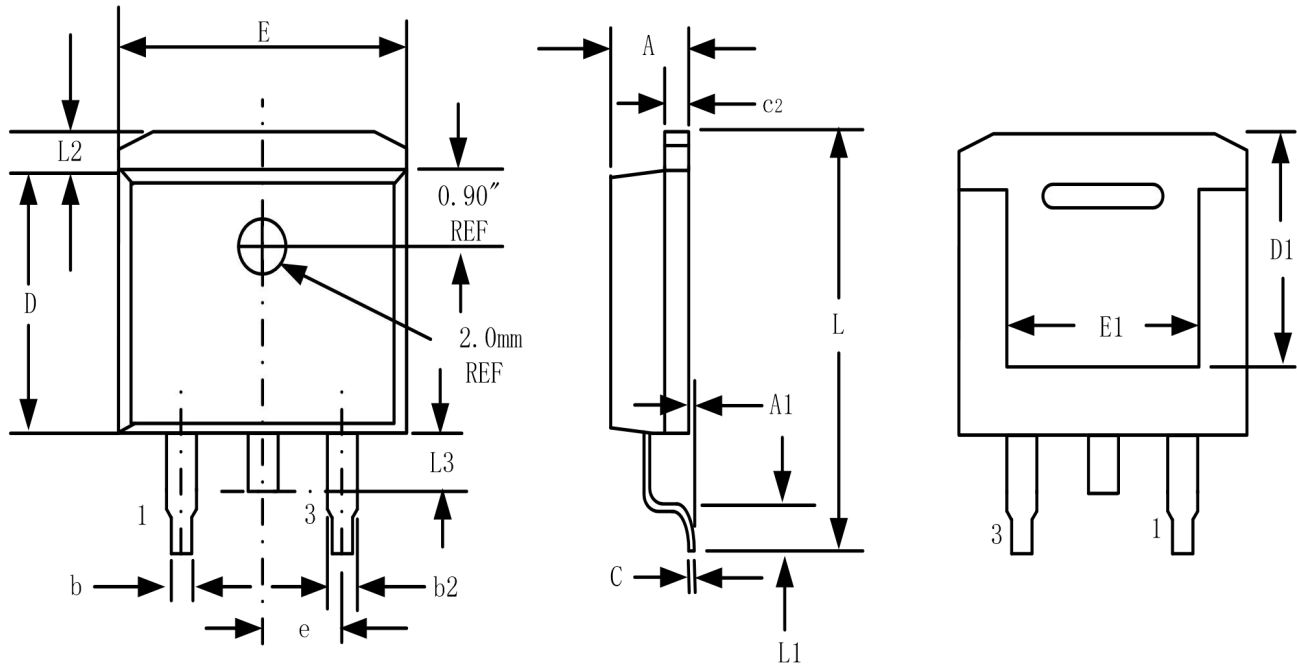

Symbol	Dimensions In Millimeters		Dimensions In Inches	
	Min.	Max.	Min.	Max.
A	4.32	4.57	0.170	0.180
A1	-	0.25		0.010
b	0.71	0.94	0.028	0.037
b2	1.15	1.40	0.045	0.055
c	0.46	0.61	0.018	0.024
c2	1.22	1.40	0.048	0.055
D	8.89	9.40	0.350	0.370
D1	8.01	8.23	0.315	0.324
E	10.04	10.28	0.395	0.405
E1	7.88	8.08	0.310	0.318
e	2.54 BSC		0.100 BSC	
L	14.73	15.75	0.580	0.620
L1	2.29	2.79	0.090	0.110
L2	1.15	1.39	0.045	0.055
L3	1.27	1.77	0.050	0.070



## TO-220F Package Information

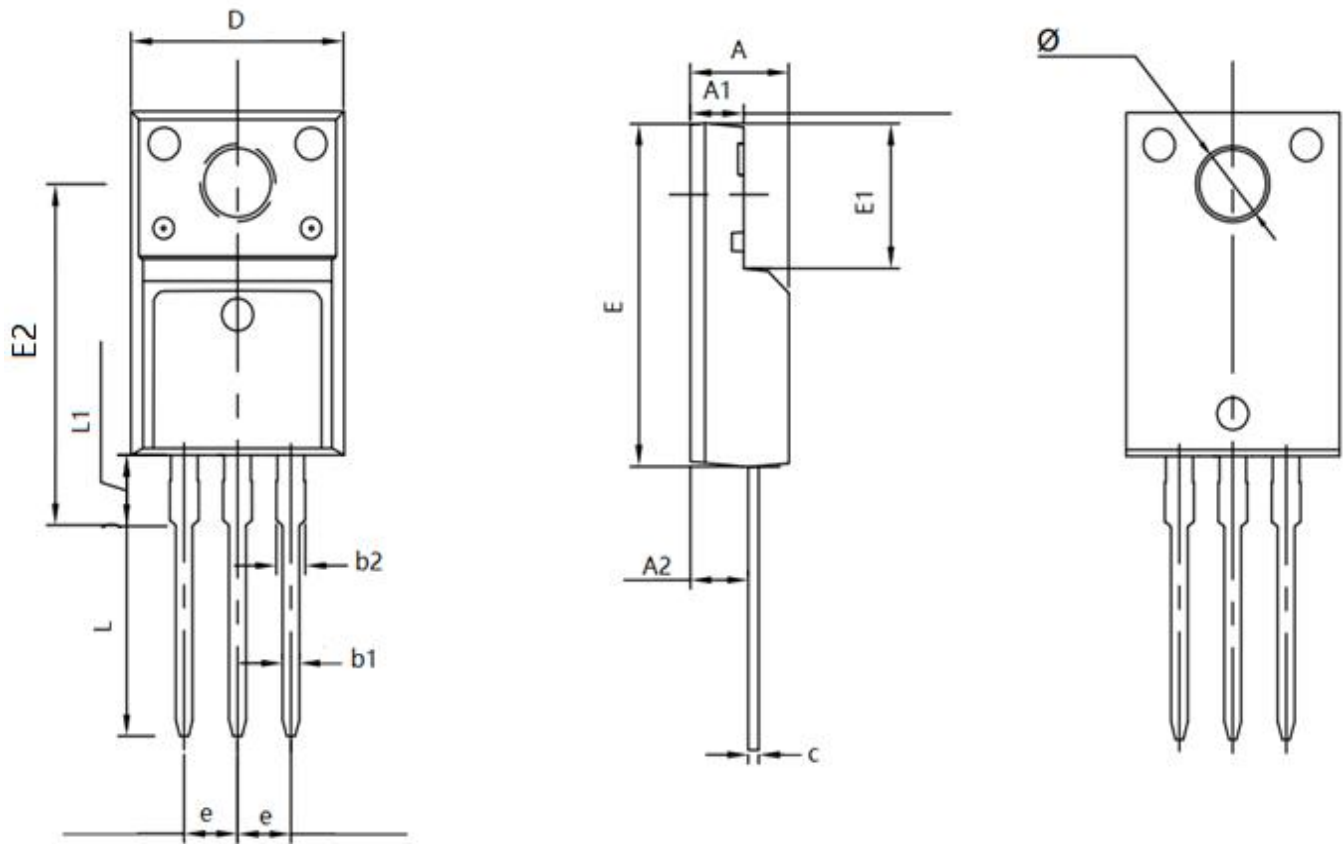

Symbol	Dimensions In Millimeters		Dimensions In Inches	
	Min.	Max.	Min.	Max.
A	4.500	4.900	0.177	0.193
A1	2.340	2.740	0.092	0.108
A2	2.560	2.960	0.101	0.117
b1	0.700	0.900	0.028	0.035
b2	1.180	1.580	0.046	0.062
c	0.400	0.600	0.016	0.024
D	9.960	10.360	0.392	0.408
E	15.670	15.970	0.617	0.629
E1	6.500	6.900	0.256	0.272
E2	15.500	16.100	0.610	0.634
e	2.540 TYP		0.100 TYP	
φ	3.080	3.280	0.121	0.129
L	12.640	13.240	0.498	0.521
L1	3.030	3.430	0.119	0.135

---

## ATTENTION:

- Any and all NCE products described or contained herein do not have specifications that can handle applications that require extremely high levels of reliability, such as life-support systems, aircraft's control systems, or other applications whose failure can be reasonably expected to result in serious physical and/or material damage. Consult with your NCE representative nearest you before using any NCE products described or contained herein in such applications.
- NCE assumes no responsibility for equipment failures that result from using products at values that exceed, even momentarily, rated values (such as maximum ratings, operating condition ranges, or other parameters) listed in products specifications of any and all NCE products described or contained herein.
- Specifications of any and all NCE products described or contained herein stipulate the performance, characteristics, and functions of the described products in the independent state, and are not guarantees of the performance, characteristics, and functions of the described products as mounted in the customer's products or equipment. To verify symptoms and states that cannot be evaluated in an independent device, the customer should always evaluate and test devices mounted in the customer's products or equipment.
- NCE Power Semiconductor CO.,LTD. strives to supply high-quality high-reliability products. However, any and all semiconductor products fail with some probability. It is possible that these probabilistic failures could give rise to accidents or events that could endanger human lives, that could give rise to smoke or fire, or that could cause damage to other property. When designing equipment, adopt safety measures so that these kinds of accidents or events cannot occur. Such measures include but are not limited to protective circuits and error prevention circuits for safe design, redundant design, and structural design.
- In the event that any or all NCE products(including technical data, services) described or contained herein are controlled under any of applicable local export control laws and regulations, such products must not be exported without obtaining the export license from the authorities concerned in accordance with the above law.
- No part of this publication may be reproduced or transmitted in any form or by any means, electronic or mechanical, including photocopying and recording, or any information storage or retrieval system, or otherwise, without the prior written permission of NCE Power Semiconductor CO.,LTD.
- Information (including circuit diagrams and circuit parameters) herein is for example only ; it is not guaranteed for volume production. NCE believes information herein is accurate and reliable, but no guarantees are made or implied regarding its use or any infringements of intellectual property rights or other rights of third parties.
- Any and all information described or contained herein are subject to change without notice due to product/technology improvement, etc. When designing equipment, refer to the "Delivery Specification" for the NCE product that you intend to use.
- This catalog provides information as of Mar. 2010. Specifications and information herein are subject to change without notice.