

## P-Channel 60-V (D-S) MOSFET

PRODUCT SUMMARY		
$V_{DS}$ (V)	- 60	
$R_{DS(on)}$ ( $\Omega$ )	$V_{GS} = - 10$ V	0.04
$Q_g$ (Max.) (nC)	12	
$Q_{gs}$ (nC)	3.8	
$Q_{gd}$ (nC)	5.1	
Configuration	Single	

### FEATURES

- Isolated Package
- High Voltage Isolation = 2.5 kV<sub>RMS</sub> (t = 60 s; f = 60 Hz)
- Sink to Lead Creepage Distance = 4.8 mm
- P-Channel
- 175 °C Operating Temperature
- Dynamic dV/dt Rating
- Low Thermal Resistance
- Lead (Pb)-free Available



Available  
**RoHS\***  
COMPLIANT

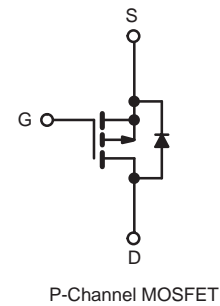
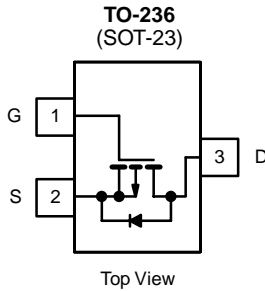

ABSOLUTE MAXIMUM RATINGS $T_C = 25$ °C, unless otherwise noted					
PARAMETER		SYMBOL	LIMIT	UNIT	
Drain-Source Voltage		$V_{DS}$	- 60	V	
Gate-Source Voltage		$V_{GS}$	$\pm 20$		
Continuous Drain Current	$V_{GS}$ at - 10 V	$I_D$	$T_C = 25$ °C	- 5.2	A
			$T_C = 100$ °C	- 3.8	
Pulsed Drain Current <sup>a</sup>		$I_{DM}$	- 21		
Linear Derating Factor			0.18	W/°C	
Single Pulse Avalanche Energy <sup>b</sup>		$E_{AS}$	120	mJ	
Repetitive Avalanche Current <sup>a</sup>		$I_{AR}$	- 5.2	A	
Repetitive Avalanche Energy <sup>a</sup>		$E_{AR}$	2.7	mJ	
Maximum Power Dissipation	$T_C = 25$ °C	$P_D$	27	W	
Peak Diode Recovery dV/dt <sup>c</sup>		dV/dt	- 4.5	V/ns	
Operating Junction and Storage Temperature Range		$T_J, T_{stg}$	- 55 to + 175	°C	
Soldering Recommendations (Peak Temperature)	for 10 s		300 <sup>d</sup>		
Mounting Torque	6-32 or M3 screw		10		lbf · in
			1.1	N · m	

### Notes

- Repetitive rating; pulse width limited by maximum junction temperature (see fig. 11).
- $V_{DD} = - 25$  V, starting  $T_J = 25$  °C, L = 5.0 mH,  $R_G = 25$   $\Omega$ ,  $I_{AS} = - 5.3$  A (see fig. 12).
- $I_{SD} \leq - 6.7$  A,  $dI/dt \leq 90$  A/ $\mu$ s,  $V_{DD} \leq V_{DS}$ ,  $T_J \leq 175$  °C.
- 1.6 mm from case.

THERMAL RESISTANCE RATINGS				
PARAMETER	SYMBOL	TYP.	MAX.	UNIT
Maximum Junction-to-Ambient	$R_{thJA}$	-	65	°C/W
Maximum Junction-to-Case (Drain)	$R_{thJC}$	-	5.5	

SPECIFICATIONS $T_J = 25\text{ }^\circ\text{C}$ , unless otherwise noted						
PARAMETER	SYMBOL	TEST CONDITIONS	MIN.	TYP.	MAX.	UNIT
<b>Static</b>						
Drain-Source Breakdown Voltage	$V_{DS}$	$V_{GS} = 0\text{ V}, I_D = -250\text{ }\mu\text{A}$	-60	-	-	V
$V_{DS}$ Temperature Coefficient	$\Delta V_{DS}/T_J$	Reference to $25\text{ }^\circ\text{C}$ , $I_D = -1\text{ mA}$	-	-0.060	-	V/°C
Gate-Source Threshold Voltage	$V_{GS(th)}$	$V_{DS} = V_{GS}, I_D = -250\text{ }\mu\text{A}$	-1.0	-	-2.5	V
Gate-Source Leakage	$I_{GSS}$	$V_{GS} = \pm 20\text{ V}$	-	-	$\pm 100$	nA
Zero Gate Voltage Drain Current	$I_{DSS}$	$V_{DS} = -60\text{ V}, V_{GS} = 0\text{ V}$	-	-	-100	$\mu\text{A}$
		$V_{DS} = -48\text{ V}, V_{GS} = 0\text{ V}, T_J = 150\text{ }^\circ\text{C}$	-	-	-500	
Drain-Source On-State Resistance	$R_{DS(on)}$	$V_{GS} = -10\text{ V}, I_D = -3.2\text{ A}^b$	-	0.05	-	$\Omega$
Forward Transconductance	$g_{fs}$	$V_{DS} = -25\text{ V}, I_D = -3.2\text{ A}^b$	1.6	-	-	S
<b>Dynamic</b>						
Input Capacitance	$C_{iss}$	$V_{GS} = 0\text{ V}, V_{DS} = -25\text{ V}, f = 1.0\text{ MHz}$ , see fig. 5	-	270	-	pF
Output Capacitance	$C_{oss}$		-	170	-	
Reverse Transfer Capacitance	$C_{rss}$		-	31	-	
Drain to Sink Capacitance	$C$	$f = 1.0\text{ MHz}$	-	12	-	
Total Gate Charge	$Q_g$	$V_{GS} = -10\text{ V}, I_D = -4.7\text{ A}, V_{DS} = -48\text{ V}$ , see fig. 6 and 13 <sup>b</sup>	-	-	12	nC
Gate-Source Charge	$Q_{gs}$		-	-	3.8	
Gate-Drain Charge	$Q_{gd}$		-	-	5.1	
Turn-On Delay Time	$t_{d(on)}$	$V_{DD} = -30\text{ V}, I_D = -4.7\text{ A}, R_G = 24\text{ }\Omega, R_D = 4.0\text{ }\Omega$ , see fig. 10 <sup>b</sup>	-	11	-	ns
Rise Time	$t_r$		-	63	-	
Turn-Off Delay Time	$t_{d(off)}$		-	9.6	-	
Fall Time	$t_f$		-	31	-	
Internal Drain Inductance	$L_D$	Between lead, 6 mm (0.25") from package and center of die contact	-	4.5	-	nH
Internal Source Inductance	$L_S$		-	7.5	-	
<b>Drain-Source Body Diode Characteristics</b>						
Continuous Source-Drain Diode Current	$I_S$	MOSFET symbol showing the integral reverse p - n junction diode	-	-	-5.2	A
Pulsed Diode Forward Current <sup>a</sup>	$I_{SM}$		-	-	-21	
Body Diode Voltage	$V_{SD}$	$T_J = 25\text{ }^\circ\text{C}, I_S = -5.2\text{ A}, V_{GS} = 0\text{ V}^b$	-	-	-5.5	V
Body Diode Reverse Recovery Time	$t_{rr}$	$T_J = 25\text{ }^\circ\text{C}, I_F = -4.7\text{ A}, dI/dt = 100\text{ A}/\mu\text{s}^b$	-	80	160	ns
Body Diode Reverse Recovery Charge	$Q_{rr}$		-	0.096	0.19	$\mu\text{C}$
Forward Turn-On Time	$t_{on}$	Intrinsic turn-on time is negligible (turn-on is dominated by $L_S$ and $L_D$ )				

**Notes**

- a. Repetitive rating; pulse width limited by maximum junction temperature (see fig. 11).  
 b. Pulse width  $\leq 300\text{ }\mu\text{s}$ ; duty cycle  $\leq 2\%$ .

**TYPICAL CHARACTERISTICS** 25 °C, unless otherwise noted

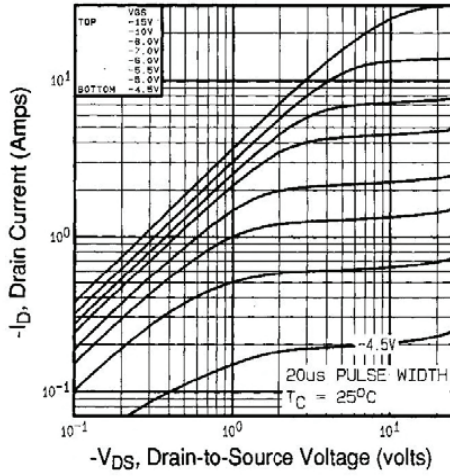

Fig. 1 - Typical Output Characteristics,  $T_C = 25\text{ }^\circ\text{C}$

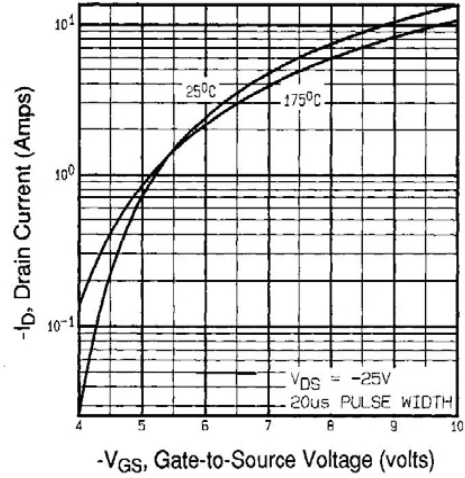

Fig. 3 - Typical Transfer Characteristics

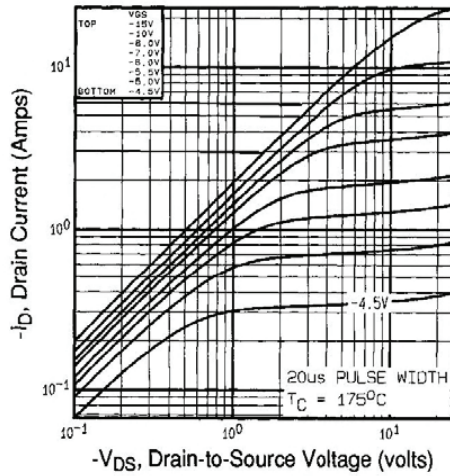

Fig. 2 - Typical Output Characteristics,  $T_C = 175\text{ }^\circ\text{C}$

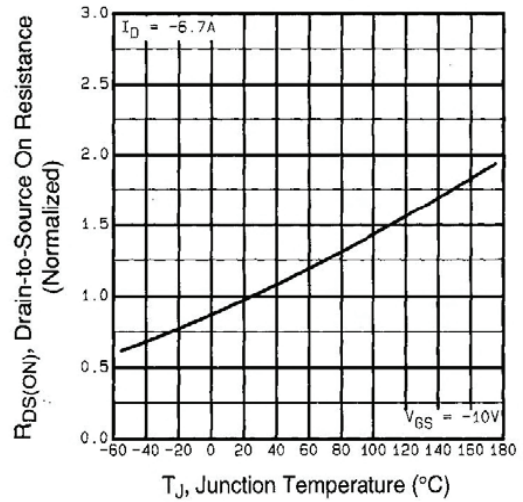

Fig. 4 - Normalized On-Resistance vs. Temperature

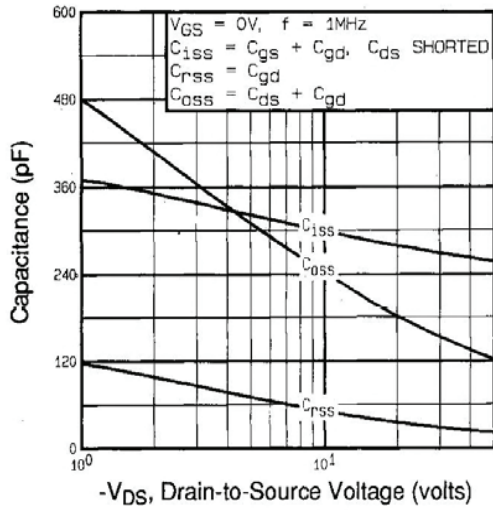

Fig. 5 - Typical Capacitance vs. Drain-to-Source Voltage

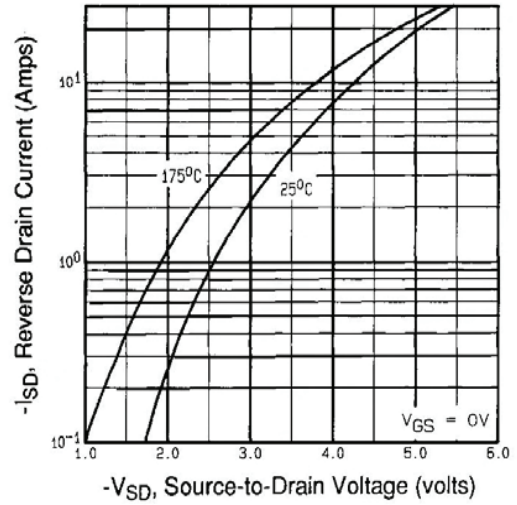

Fig. 7 - Typical Source-Drain Diode Forward Voltage

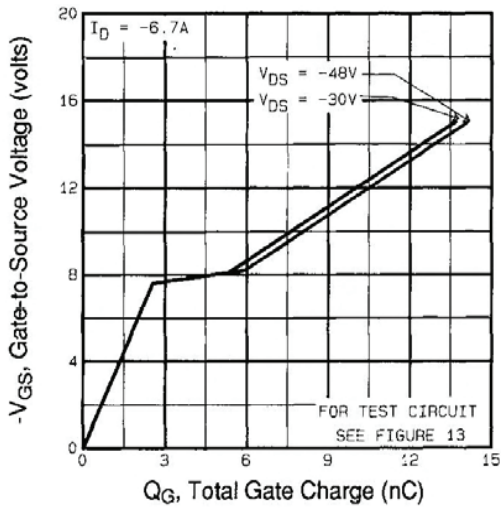

Fig. 6 - Typical Gate Charge vs. Gate-to-Source Voltage

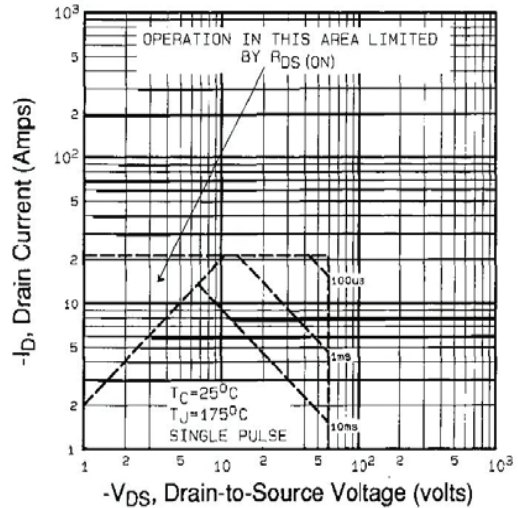

Fig. 8 - Maximum Safe Operating Area

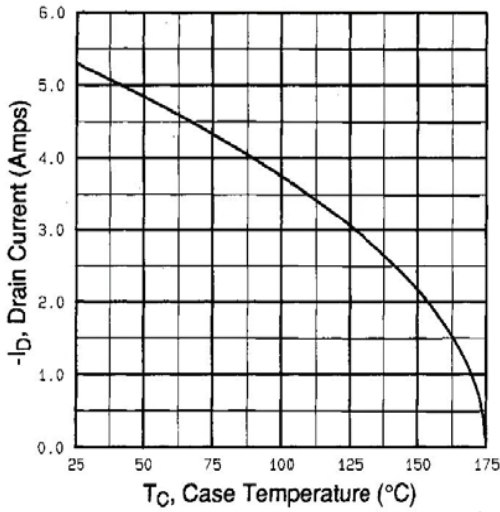

Fig. 9 - Maximum Drain Current vs. Case Temperature

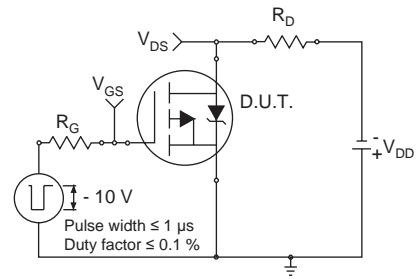

Fig. 10a - Switching Time Test Circuit

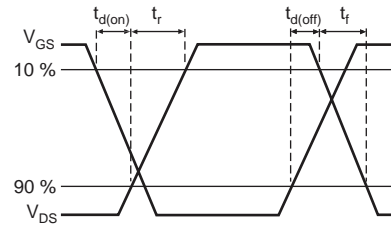

Fig. 10b - Switching Time Waveforms

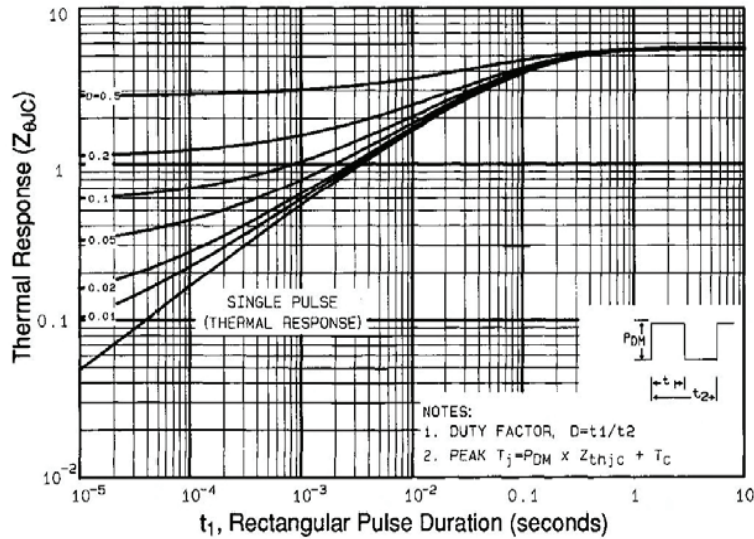

Fig. 11 - Maximum Effective Transient Thermal Impedance, Junction-to-Case

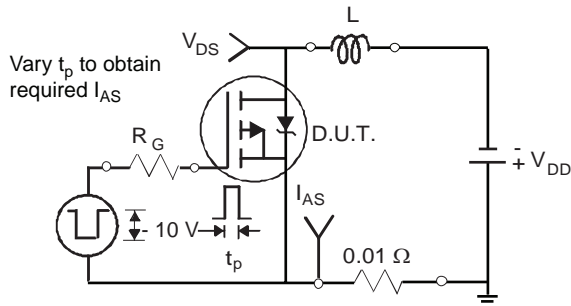

Fig. 12a - Unclamped Inductive Test Circuit

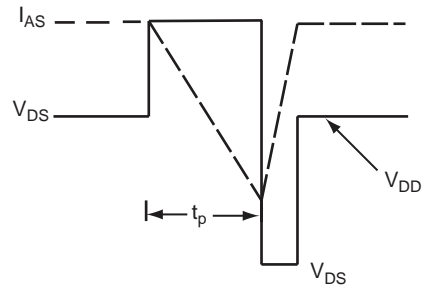

Fig. 12b - Unclamped Inductive Waveforms

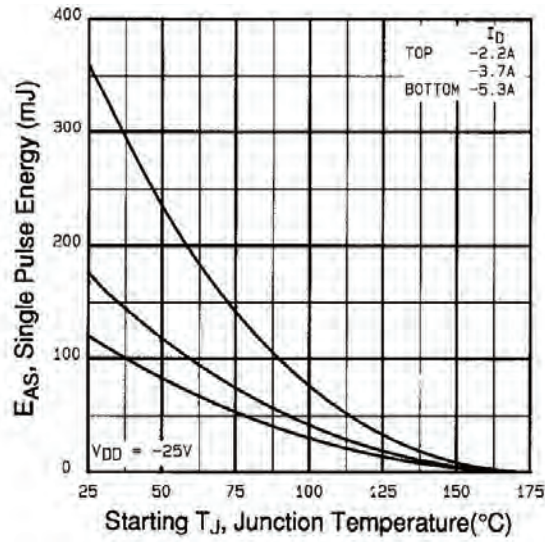

Fig. 12c - Maximum Avalanche Energy vs. Drain Current

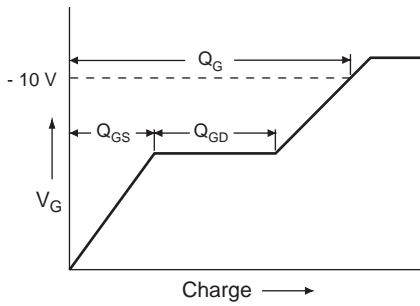

Fig. 13a - Basic Gate Charge Waveform

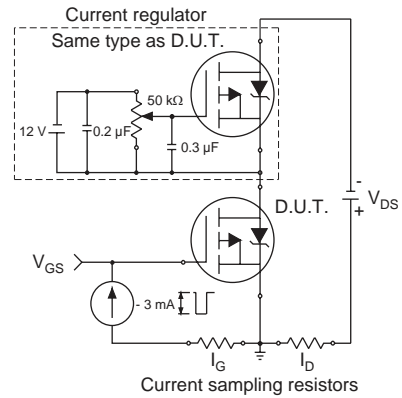
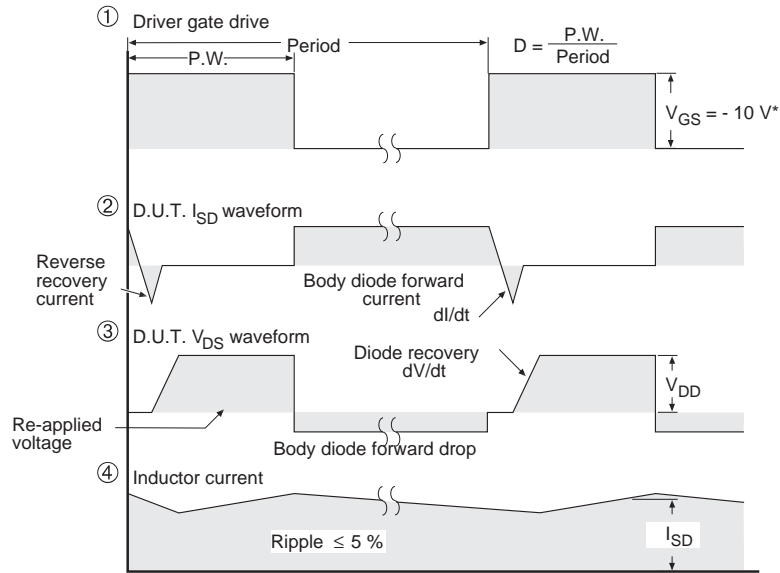
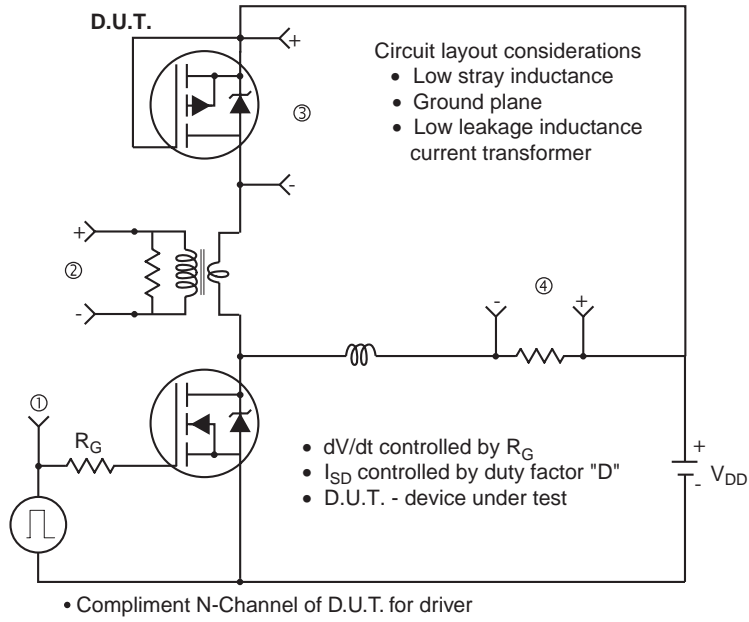

Fig. 13b - Gate Charge Test Circuit

**Peak Diode Recovery dV/dt Test Circuit**



\*  $V_{GS} = -5V$  for logic level and  $-3V$  drive devices

**Fig. 14 - For P-Channel**

**SOT-23 (TO-236): 3-LEAD**

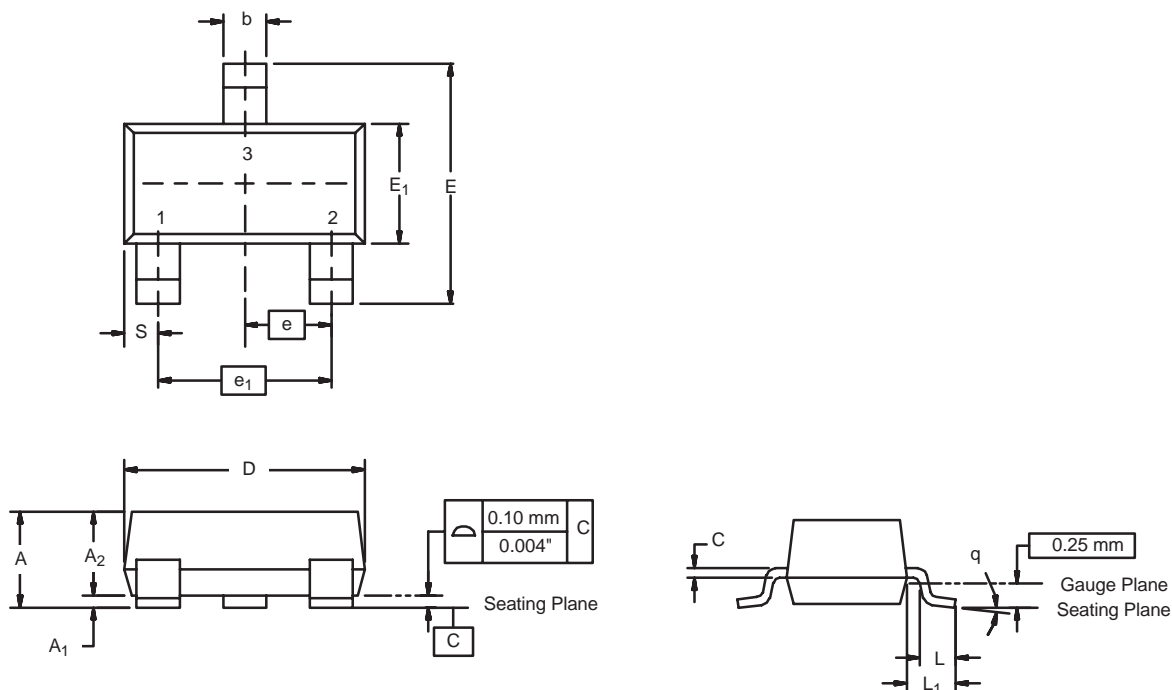

Dim	MILLIMETERS		INCHES	
	Min	Max	Min	Max
A	0.89	1.12	0.035	0.044
A <sub>1</sub>	0.01	0.10	0.0004	0.004
A <sub>2</sub>	0.88	1.02	0.0346	0.040
b	0.35	0.50	0.014	0.020
c	0.085	0.18	0.003	0.007
D	2.80	3.04	0.110	0.120
E	2.10	2.64	0.083	0.104
E <sub>1</sub>	1.20	1.40	0.047	0.055
e	0.95 BSC		0.0374 Ref	
e <sub>1</sub>	1.90 BSC		0.0748 Ref	
L	0.40	0.60	0.016	0.024
L <sub>1</sub>	0.64 Ref		0.025 Ref	
S	0.50 Ref		0.020 Ref	
q	3°	8°	3°	8°

ECN: S-03946-Rev. K, 09-Jul-01  
DWG: 5479



RECOMMENDED MINIMUM PADS FOR SOT-23

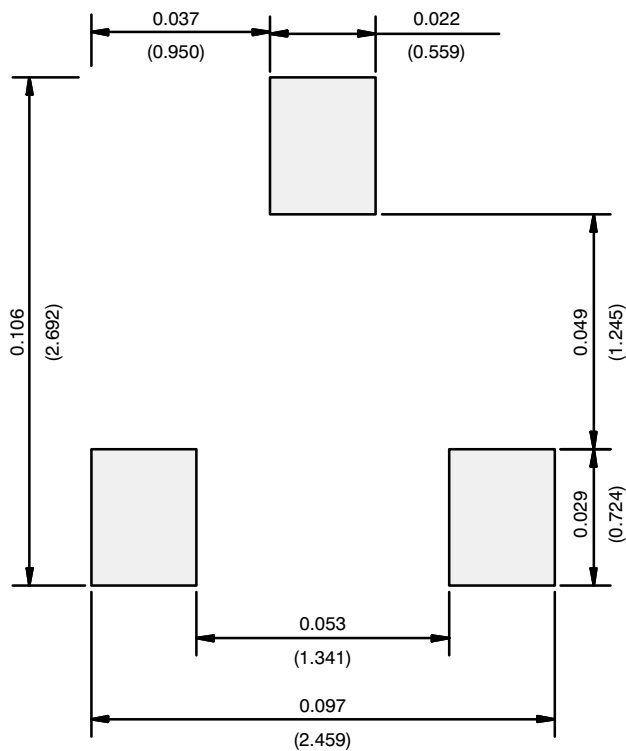

Recommended Minimum Pads  
Dimensions in Inches/(mm)

# Disclaimer

All products due to improve reliability, function or design or for other reasons, product specifications and data are subject to change without notice.

Taiwan VBsemi Electronics Co., Ltd., branches, agents, employees, and all persons acting on its or their representatives (collectively, the "Taiwan VBsemi"), assumes no responsibility for any errors, inaccuracies or incomplete data contained in the table or any other any disclosure of any information related to the product.(www.VBsemi.com)

Taiwan VBsemi makes no guarantee, representation or warranty on the product for any particular purpose of any goods or continuous production. To the maximum extent permitted by applicable law on Taiwan VBsemi relinquished: (1) any application and all liability arising out of or use of any products; (2) any and all liability, including but not limited to special, consequential damages or incidental ; (3) any and all implied warranties, including a particular purpose, non-infringement and merchantability guarantee.

Statement on certain types of applications are based on knowledge of the product is often used in a typical application of the general product VBsemi Taiwan demand that the Taiwan VBsemi of. Statement on whether the product is suitable for a particular application is non-binding. It is the customer's responsibility to verify specific product features in the products described in the specification is appropriate for use in a particular application. Parameter data sheets and technical specifications can be provided may vary depending on the application and performance over time. All operating parameters, including typical parameters must be made by customer's technical experts validated for each customer application. Product specifications do not expand or modify Taiwan VBsemi purchasing terms and conditions, including but not limited to warranty herein.

Unless expressly stated in writing, Taiwan VBsemi products are not intended for use in medical, life saving, or life sustaining applications or any other application. Wherein VBsemi product failure could lead to personal injury or death, use or sale of products used in Taiwan VBsemi such applications using client did not express their own risk. Contact your authorized Taiwan VBsemi people who are related to product design applications and other terms and conditions in writing.

The information provided in this document and the company's products without a license, express or implied, by estoppel or otherwise, to any intellectual property rights granted to the VBsemi act or document. Product names and trademarks referred to herein are trademarks of their respective representatives will be all.

## Material Category Policy

**Taiwan VBsemi Electronics Co., Ltd., hereby certify that all of the products are determined to be RoHS compliant and meets the definition of restrictions under Directive of the European Parliament 2011/65 / EU, 2011 Nian. 6. 8 Ri Yue restrict the use of certain hazardous substances in electrical and electronic equipment (EEE) - modification, unless otherwise specified as inconsistent.(www.VBsemi.com)**

**Please note that some documents may still refer to Taiwan VBsemi RoHS Directive 2002/95 / EC. We confirm that all products identified as consistent with the Directive 2002/95 / EC European Directive 2011/65 /.**

**Taiwan VBsemi Electronics Co., Ltd. hereby certify that all of its products comply identified as halogen-free halogen-free standards required by the JEDEC JS709A. Please note that some Taiwanese VBsemi documents still refer to the definition of IEC 61249-2-21, and we are sure that all products conform to confirm compliance with IEC 61249-2-21 standard level JS709A.**