

免电感滤波40W AB/D类音频功放

40W Inductor Free Class AB/D Mono Amplifier

■ FEATURES

- Output Power
15W (VDD=12V, RL=4Ω, THD+N=1%, Class D)
32W (VDD=18V, RL=4Ω, THD+N=1%, Class D)
40W (VDD=18V, RL=4Ω, THD+N=10%, Class D)
7.5W (VDD=7.4V, RL=4Ω, THD+N=10%, Class AB)
17W (VDD=12V, RL=4Ω, THD+N=10%, Class AB)
- Single Wide Voltage Supply: 3V-18V
- Low Quiescent Current: 7mA (VDD = 12V, with LC and Load, Class D)
- Anti-clipping Function (ACF)
- Spread Switching Frequency, Inductor-free Operation
- Differential / Single-ended Analog Input
- Integrated Self-protection Circuits Including, Undervoltage, Overtemperature, and Overcurrent
- LF and HF Package of ESSOP10
- 输出功率
15W (VDD=12V, RL=4Ω, THD+N=1%, Class D)
32W (VDD=18V, RL=4Ω, THD+N=1%, Class D)
40W (VDD=18V, RL=4Ω, THD+N=10%, Class D)
7.5W (VDD=7.4V, RL=4Ω, THD+N=10%, Class AB)
17W (VDD=12V, RL=4Ω, THD+N=10%, Class AB)
- 单电源系统, 3V-18V宽电压输入范围
- 低静态电流: 7mA (VDD = 12V, 带LC 和负载, Class D)
- ACF防破音功能可选
- 扩频功能, 免电感滤波
- 模拟差分/单端输入
- 保护功能: 过流/过热/欠压异常和短路保护
- 无铅无卤封装, ESSOP10

■ APPLICATIONS

- Sound Bars
- Wireless Speakers
- Consumer Audio Applications
- TVs/Monitors
- 条形音箱
- 便携式音箱
- 拉杆音箱
- 无线智能音箱
- 消费类音频应用
- LCD电视/监视器

■ DESCRIPTION

HT3163 is a mono efficient, Class AB/D audio amplifier. In class D mode, the device can drive a speaker up to 40W/4 Ω at VDD = 18V. In class AB mode, the device can drive a speaker up to 17W/4 Ω at VDD = 12V.

Advanced EMI Suppression enables the use of inexpensive ferrite bead filters while meeting EMC requirements for system cost reduction.

HT3163 is protected with Undervoltage, Overtemperature, and Overcurrent protection.

HT3163 features Anti-Clipping Function (ACF) which detects output signal clip due to the over input signal and suppresses the output signal clip automatically. Also, the ACF function can adapt the output clip caused by power supply voltage down with battery. It can significantly improve the sound quality, creating a very comfortable musical enjoyment, and to protect the speakers from overload damage.

HT3163是一款高效AB/D类音频功率放大器。在D类模式, 18V供电、THD+N=10%条件下, 能够持续提供40W/4 Ω 功率输出。在AB类模式, 12V供电、THD+N=10%条件下, 能够持续输出17W/4 Ω 功率。

HT3163具有先进的扩频功能来抑制EMI, 使用价格低廉且小体积铁氧体磁珠可满足EMC要求。

此外, HT3163内置关断功能使待机电流最小化, 还集成了短路保护、热保护和电源欠压异常保护等功能。

HT3163具有防削顶失真 (ACF) 输出控制功能, 可检测并抑制由于输入音乐、语音信号幅度过大所引起的输出信号削顶失真 (破音), 也能自适应地防止在电源电压下降所造成的输出削顶, 显著提高音质, 创造非常舒适的听音享受, 并保护扬声器免受过载损坏。

■ TYPICAL APPLICATION

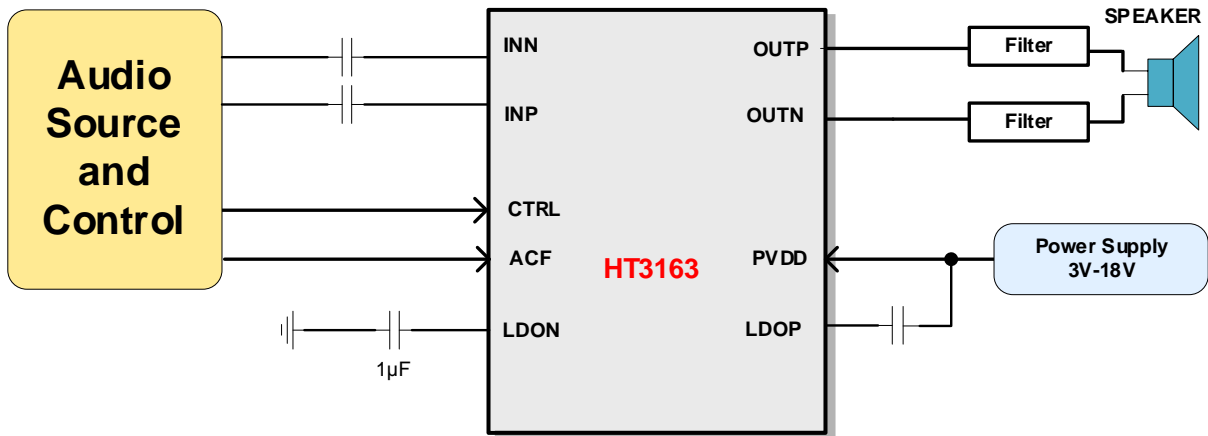

ORDERING INFORMATION

Part Number	Package Type	Marking	Operating Temperature Range	Shipping Package / MOQ
HT3163SPER	SSOP10 (SPE)	HT3163 YYYMAAB ¹	-40℃~85℃	Tape and Reel (R) / 2500pcs
HT3163SPET	SSOP10 (SPE)	HT3163 YYYMAAB	-40℃~85℃	Tube (T) / 100pcs

Part Number

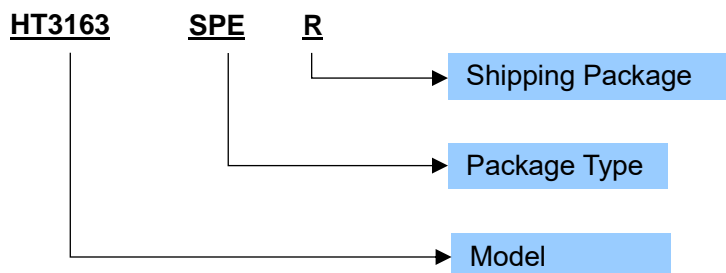

Production Tracking Code

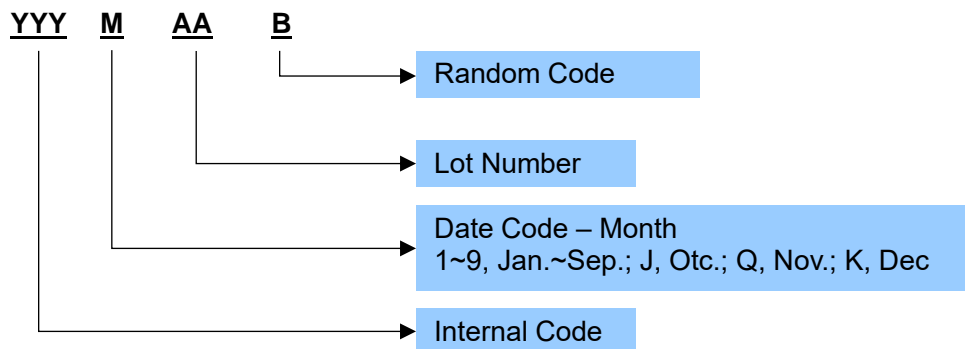

¹ YYYMAAB is production tracking code

■ TERMINAL CONFIGURATION

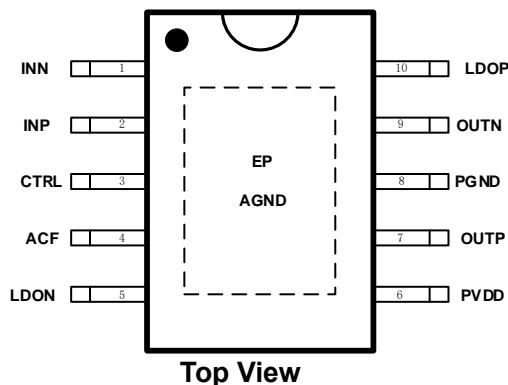

■ TERMINAL FUNCTION

Terminal No.	Name	I/O ¹	Description
1	INN	I	Negative input terminal
2	INP	I	Positive input terminal
3	CTRL	I	Working mode selection terminal
4	ACF	O	ACF mode selection terminal
5	LDON	O	Internal LDO output, connect 1uF to GND
6	PVDD	P	Power Supply
7	OUTP	O	Positive pin for differential speaker amplifier output
8	PGND	G	Power Ground
9	OUTN	O	Negative pin for differential speaker amplifier output
10	LDOP	O	Internal LDO output, connect 1uF to PVDD
EP	AGND	G	Analog ground. Provides both electrical and thermal connection from the device to the board. A matching ground pad must be provided on the PCB and the device connected to it via solder. For proper electrical operation, this ground pad must be connected to the system ground. 既是地，又是散热PAD

¹ I: Input; O: Output; G: Ground; P: Power;

■ SPECIFICATIONS¹
● Absolute Maximum Ratings²

PARAMETER	Symbol	MIN	MAX	UNIT
Supply voltage range (PVDD)	PVDD	-0.3	20	V
Input voltage range (INP, INN, CTRL, ACF)	V _I	-0.3	5.8	V
Operating temperature range	T _A	-40	85	°C
Operating junction temperature range	T _J	-40	150	°C
Storage temperature range	T _{STG}	-50	150	°C

● Recommended Operating Conditions

PARAMETER	Symbol	CONDITION	MIN	TYP	MAX	UNIT
Supply voltage range	V _{DD}	VDD	3		18	V
Operating temperature	T _a		-40	25	85	°C
CTRL terminal working mode	MODE1	V _{MODE1}	spread spectrum off, Class D mode		5.5	V
	MODE2	V _{MODE2}	Spread spectrum on, Class D mode		1.9	V
	MODE3	V _{MODE3}	Class AB mode		0.8	V
	MODE4	V _{MODE4}	shutdown		0.5	V
Load impedance	R _L	With output filter		4		Ω

● Electrical Specification³

Conditions: T_A = 25°C, PVDD = 3V-18V, Load = 4ohm, Class D or Class AB mode, unless otherwise specified.

PARAMETER	Symbol	CONDITION	MIN	TYP	MAX	UNIT
Class Output Offset Voltage	V _{OS}	V _I = 0V, Gain = 26dB		1.5		mV
Quiescent supply current	I _{DD}	V _{DD} = 12V, output filter = 10uH+680nF, Load = 4ohm, Class D mode		7		mA
		V _{DD} = 12V, output filter = 10uH+680nF, Load = 4ohm, Class AB mode		42		mA
Quiescent supply current in MUTE mode	I _{MUTE}	V _{DD} = 12V, With Load		4		mA
Quiescent supply current in shutdown mode	I _{SD}	V _{DD} = 12V, With Load		35		uA
Common mode rejection ratio	CMRR	V _{IC} = 0.1V, PVDD = 12V		-65		dB
System Gain	Gain	R _{in} = 0kΩ		36		dB
		R _{in} = 20kΩ		26		dB
Turn-on time	t _{on}	Pull CTRL high or power on, or switch between Class AB and Class D		170		ms
Turn-off time	t _{off}	Pull CTRL low		5		us
Delay time of MUTE	t _{MUTE}	Pull ACF low		22		us
LDO output voltage	LDON	PVDD = 12V, working on		5		V
		PVDD = 12V, shutdown		4.4		V
	LDOP	PVDD = 12V, working on		7		V
		PVDD = 12V, shutdown		11.9		V
Input Bias Voltage	V _{INBIAS}			1.65		V

¹ Depending on parts and PCB layout, characteristics may be changed.

² Stresses beyond those listed under absolute maximum ratings may cause permanent damage to the device. These are stress ratings only, and functional operation of the device at these or any other conditions beyond those indicated under recommended operating conditions is not implied. Exposure to absolute-maximum-rated conditions for extended periods may affect device reliability.

³ Depending on parts and pattern layout, characteristics may be changed.

Conditions: $T_A = 25^\circ\text{C}$, $P_{VDD} = 3\text{-}18\text{V}$, Load = Filter + R_L , Filter = $10\mu\text{H} + 680\text{nF}$, $R_L = 4\Omega$, $f_{IN} = 1\text{ kHz}$, Gain = 26dB, $C_{IN} = 1\mu\text{F}$, 20-20kHz, Class D or Class AB mode, unless otherwise specified.

PARAMETER	Symbol	CONDITION		MIN	TYP	MAX	UNIT
Continuous output power in Class D mode	P_O	$V_{DD} = 12\text{V}$, $R_L = 4\Omega$	THD +N = 1%		15		W
			THD+N = 10%		18		W
		$V_{DD} = 18\text{V}$, $R_L = 4\Omega$	THD +N = 1%		32		W
			THD+N = 10%		40		W
Continuous output power in Class AB mode	P_O	$V_{DD} = 7.4\text{V}$	THD+N = 10%		7.5		W
		$V_{DD} = 12\text{V}$	THD+N = 10%		17		W
Total harmonic distortion + noise	THD+N	$P_O = 1\text{W}$, $V_{DD} = 10\text{V}$, $R_L = 4\Omega$, Class D			0.12		%
		$P_O = 1\text{W}$, $V_{DD} = 10\text{V}$, $R_L = 4\Omega$, Class AB			0.35		%
Efficiency	η	$V_{DD} = 12\text{V}$, THD+N = 10%	$R_L = 4\Omega$, Class D		89		%
		$V_{DD} = 10\text{V}$, THD+N = 10%	$R_L = 4\Omega$, Class AB		78		%
Output integrated noise	V_N	A-weighted, Gain = 26 dB			115		μV
Power supply rejection ratio	PSRR	200mVpp 1kHz, Input grounded			-75		dB
Oscillator frequency	f_{osc}	Class D mode			390		kHz
Over temperature protection trigger point	OTP				150		$^\circ\text{C}$
Over current trip point	OCP				8		A

TYPICAL OPERATING CHARACTERISTICS

VDD = 12V, Load = 4ohm, Class D mode, unless otherwise specified.

I_{DD} vs V_{DD}

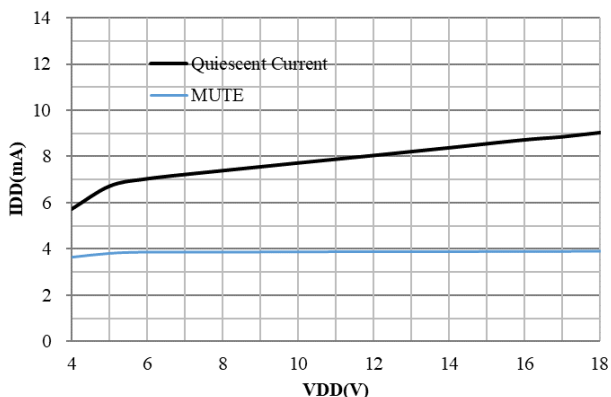

I_{SD} vs V_{DD}

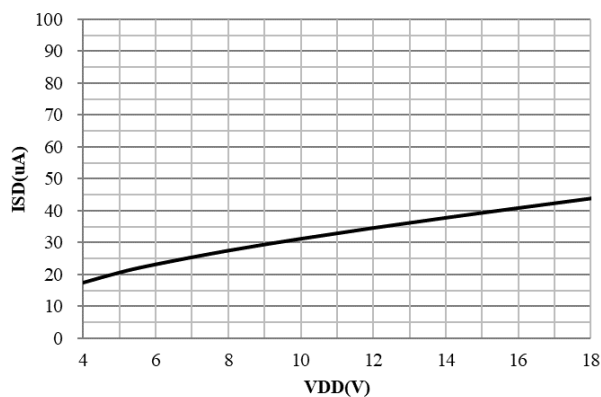

V_{DD} vs P_O

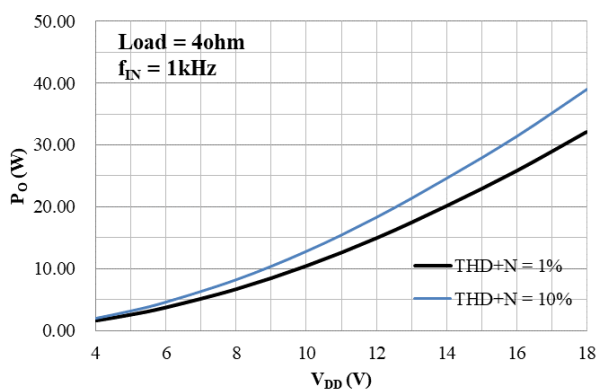

P_O vs η

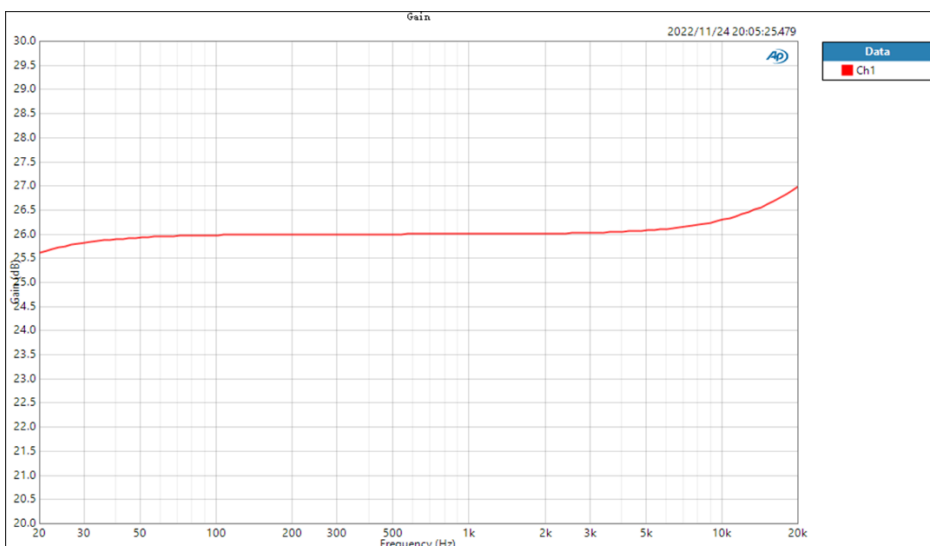
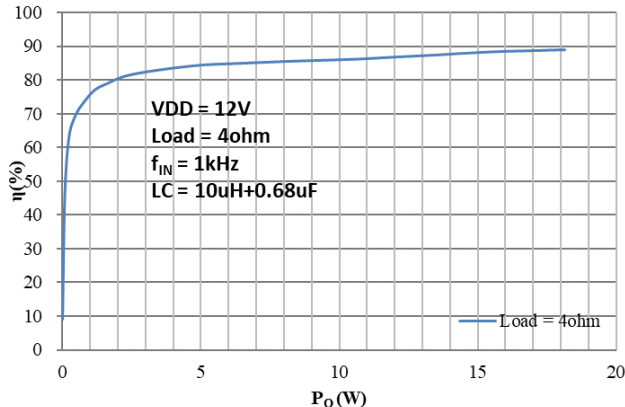

Frequency respond
(C_{in} = 1uF, R_{in}=20k, No LC filter)

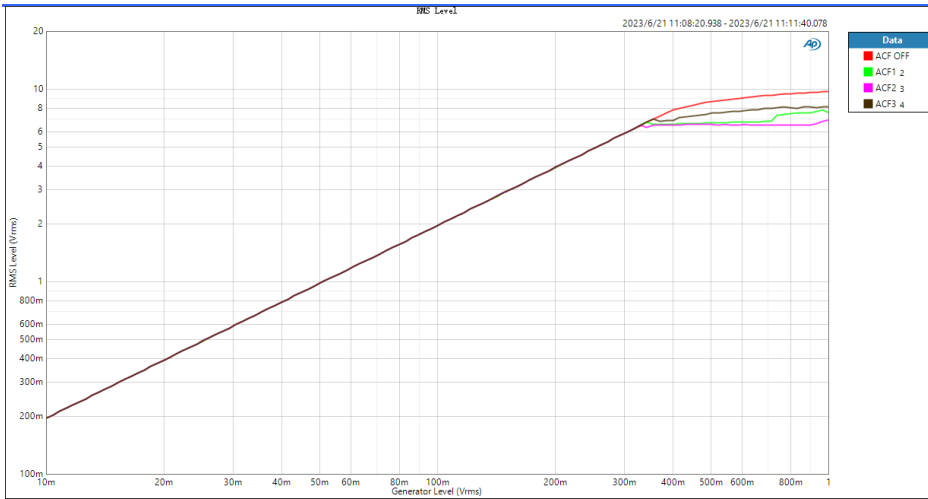

Vin vs Vout (Gain = 26dB)

$R_L = 4\Omega$, filter = 10uH+0.68uF, spread spectrum off, $f_{IN} = 1\text{kHz}$, $V_{DD}=12\text{V}$, Class D mode, unless otherwise specified.

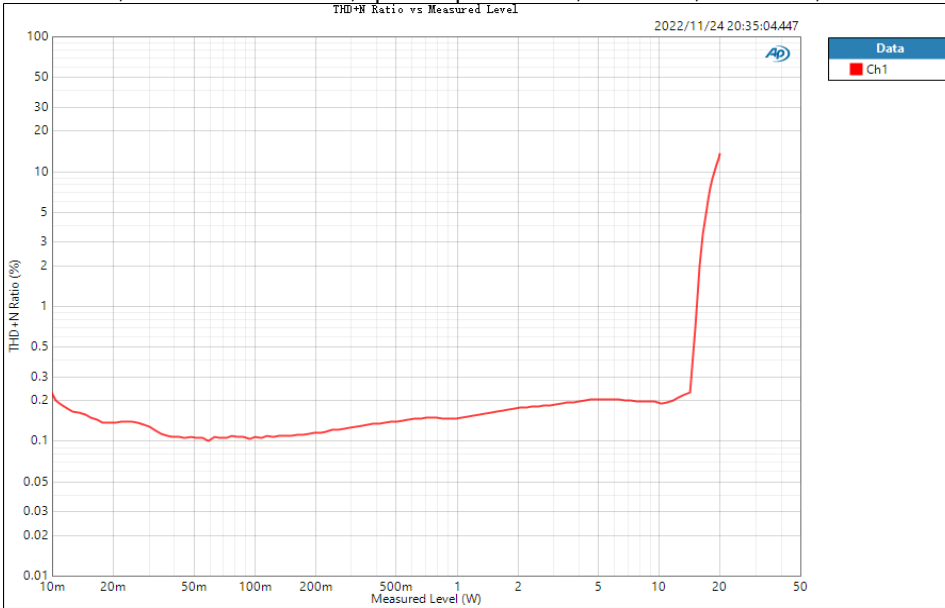

VDD = 12V, Output power vs THD+N

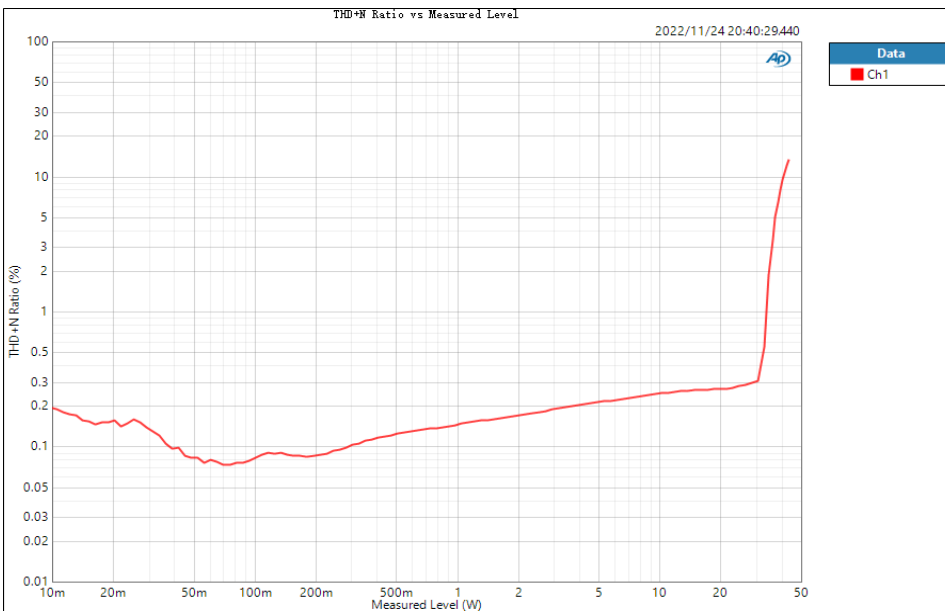

VDD = 18V, Output power vs THD+N



VDD = 12V, $P_o = 1\text{W}$, frequency vs THD+N

VDD = 12V, Load = 4ohm, Class AB mode, unless otherwise specified.

I_{DD} vs V_{DD}

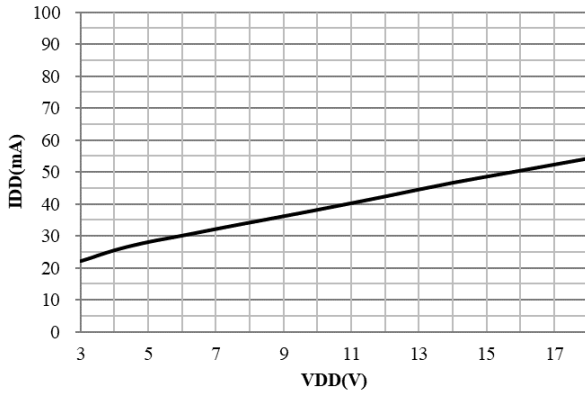

P_O vs η

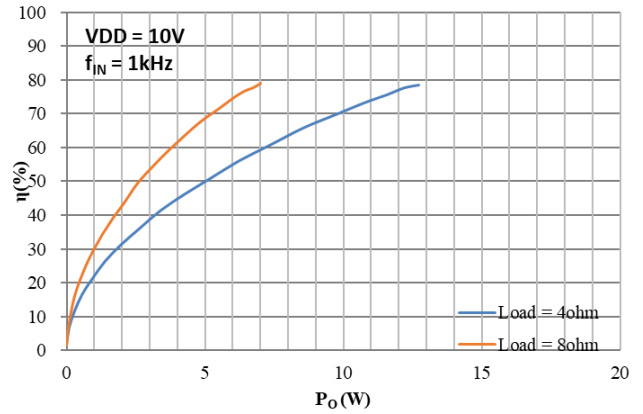

V_{DD} vs P_O

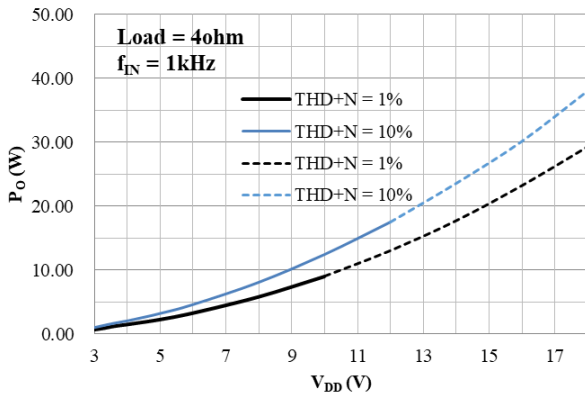

V_{DD} vs P_O

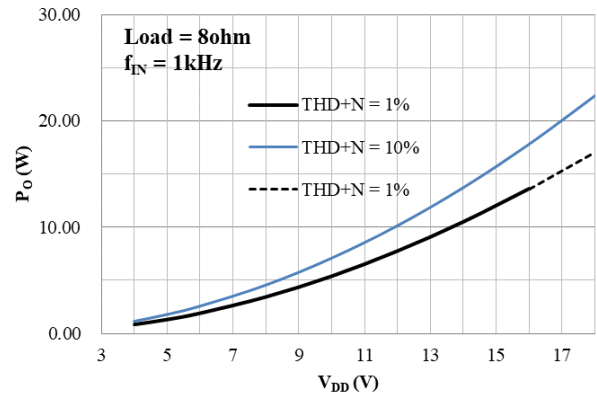

THD+N Ratio vs Measured Level

2023/6/21 10:01:27.105

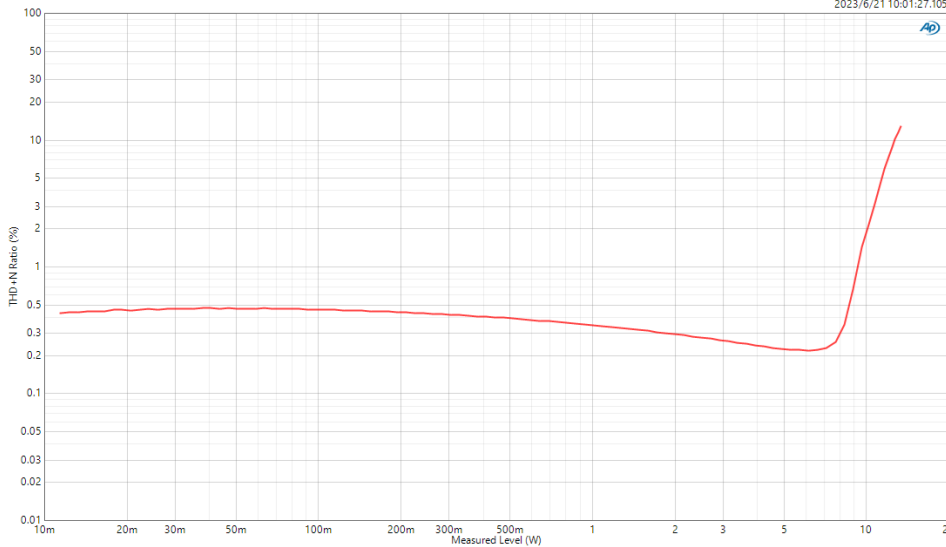

VDD = 10V, f_{IN} = 1kHz, P_O vs THD+N

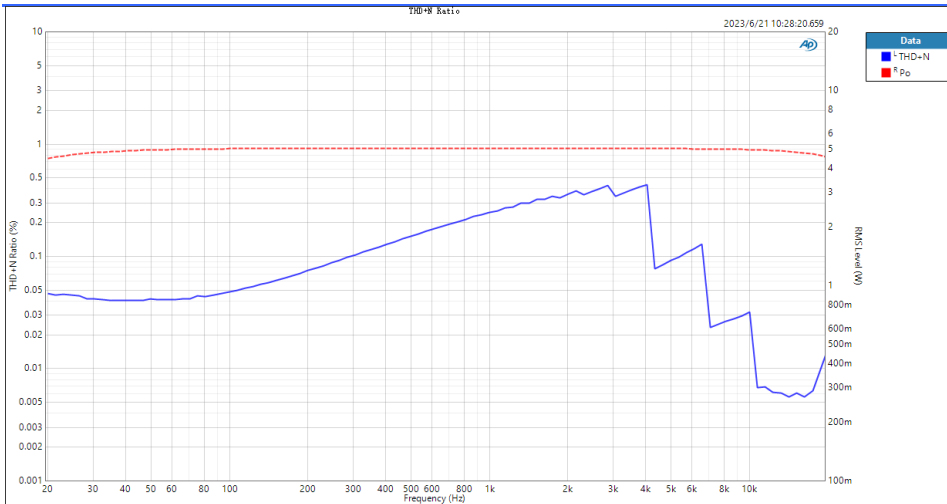

VDD = 10V, Po = 5W, f_{IN} vs THD+N

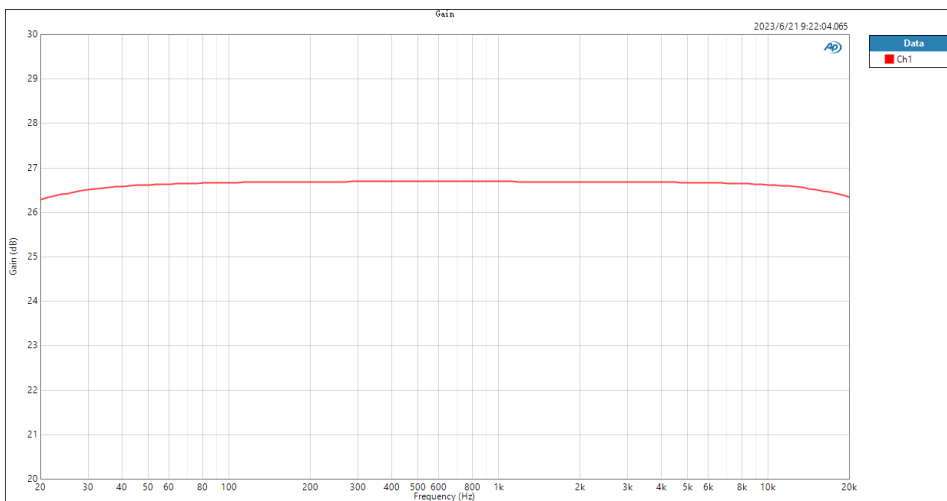

Frequency respond
(C_{in} = 1uF, R_{in}=20k, No LC filter)

APPLICATION INFORMATION

1 Power Supply

The power supply PVDD for the HT3163 only require one voltage from 3V to 18V. As the PVDD supply feed the power stage of the amplifier, filtering capacitors of 100nF//1uF//220uF for PVDD should be placed close to the PVDD pin.

LDOP and LDON are the internal LDO output. A 1uF filtering capacitor should be placed between LDON and Ground. And also, a 1uF filtering capacitor should be placed between LDOP and PVDD.

2 Amplifier Input and Output

2.1 Amplifier Input Configuration

HT3163 is an amplifier with analog input (single-ended or differential).

For a differential operation, input signals into INP and INN pins via DC-cut capacitors (C_{IN}) and external input resistors R_{EIN} . See as figure 1. The system gain can be calculated by $Gain \approx 20 \times \log\left(\frac{R_F}{R_{IIN} + R_{EIN}}\right)$, where $R_F = 630k$, $R_{IIN} = 10k$. And the high pass cut-off frequency of input signal can be calculated by $f_c = \frac{1}{2\pi(R_{IIN} + R_{EIN}) \times C_{IN}}$.

For a single-ended operation, input signals to INP pin via a DC-cut capacitor (C_{IN}) and external input resistor (R_{EIN}). INN pin should be connected to ground via a DC-cut capacitor and external input resistor (with the same value of C_{IN} and R_{EIN}). See as figure 2. The Gain and high pass Cut-off frequency are the same as the above case.

HT3163 的电源只需要一个 3V 到 18V 的电压，即 PVDD。由于其为功放的功率级供电，建议在 PVDD 端放置 100nF//1uF//220uF 的滤波电容到地，并放置在 PVDD 引脚附近。

LDOP 和 LDON 为内部 LDO 输出。LDON 需接 1uF 电容到地，LDOP 需接 1uF 电容到 PVDD。

HT3163 接受模拟差分或单端音频信号输入，产生 PWM 脉冲输出信号驱动扬声器。

对差分输入，通过隔直电容 C_{IN} 和输入电阻 R_{EIN} 分别输入到 INP 和 INN 端，见图 1。系统增益 $Gain \approx 20 \times \log\left(\frac{R_F}{R_{IIN} + R_{EIN}}\right)$ ， $R_F = 630k$ ， $R_{IIN} = 10k$ 。高通滤波器截止频率为 $f_c = \frac{1}{2\pi(R_{IIN} + R_{EIN}) \times C_{IN}}$ 。

对单端输入，则通过 C_{IN} 耦合到 INP 端。INN 端必须通过输入电阻和电容（与 C_{IN} 、 R_{EIN} 值相同）接地，见图 2。增益 Gain 和截止频率 f_c 与差分输入时相同。

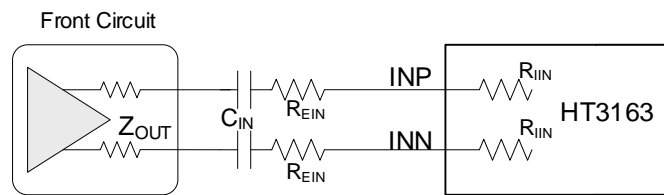

Figure 1 Differential Input configuration

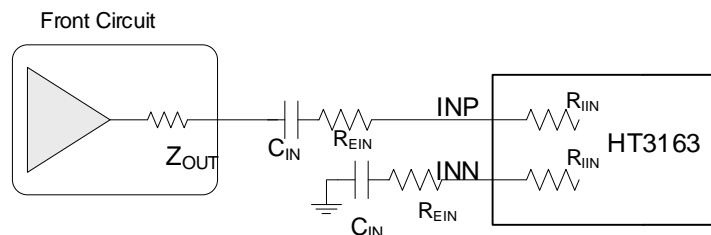

Figure 2 Single-ended Input configuration

2.2 Amplifier Output Configuration

The HT3163 has been tested with a simple ferrite bead filter for a variety of applications including long speaker wires up to 10 cm and high power. One important aspect of the ferrite bead selection is the type of material used in the ferrite bead. Not all ferrite material is alike, so it is important to select a material that is effective in the 10 to 100 MHz range which is key to the operation of the class-D amplifier. The impedance of the ferrite bead can be used along with a small capacitor with a value in the range of 1000 pF to reduce the frequency spectrum of the signal to an acceptable level. For best performance, the resonant frequency of the ferrite bead/capacitor filter should be less than 10 MHz. Also, the filter capacitor can be increased if necessary, with some impact on efficiency.

HT3163 可使用简单的铁氧体珠过滤器，在各种应用中，包括高达 10 厘米的扬声器线和较大的功率。铁氧体珠选择的一个重要方面是铁氧体珠所用材料的类型。并不是所有的铁氧体材料都是一样的，所以选择一种在 10 到 100 MHz 范围内有效的材料是很重要的，这是 D 类放大器工作的关键。铁氧体珠的阻抗可与值在 1000 pF 范围内的小电容一起使用，以将信号的频谱降低到可接受的范围。

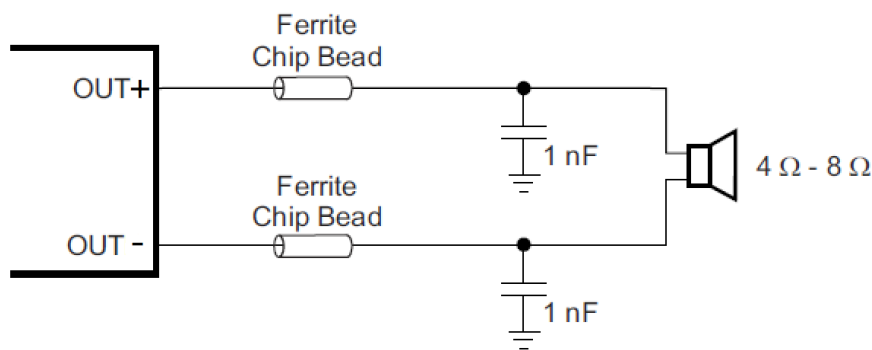

Figure 3 Output Filters with Ferrite Beads

There may be a few circuit instances where it is necessary to add a complete LC reconstruction filter. These circumstances might occur if there are nearby circuits which are sensitive to noise. In these cases, a classic second order Butterworth filter similar to those shown in the figures below can be used.

可能在一些应用场合需要添加一个完整的 LC 滤波器，比如附近有对噪声敏感的电，或 EMI 难以达到标准。此时，可以使用类似于下图所示的经典二阶巴特沃斯滤波器。

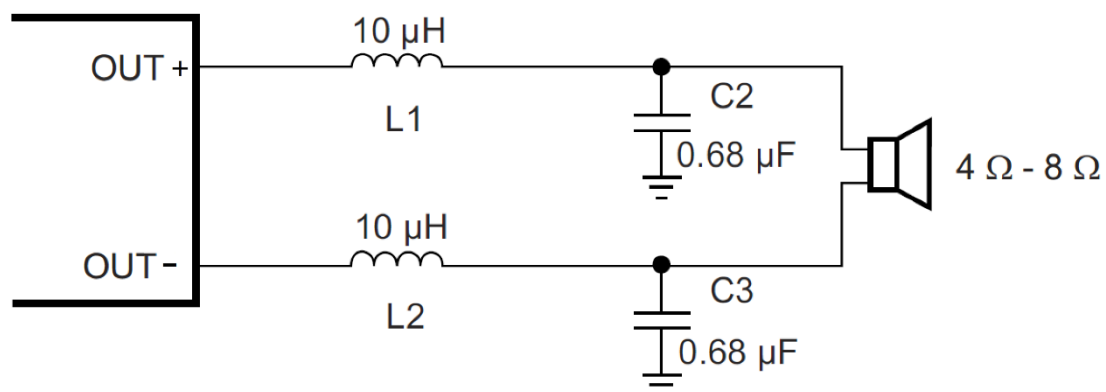

Figure 4 Output Filters with LC

3 Modulation

HT3163 works in a 3-state mode that can achieve a lower power consumption with LC filter.

HT3163 工作在 3 态模式，其在 LC 滤波条件下具有更低的静态功耗。

4 Working modes (CTRL Terminal)

HT3163 can work in different modes by setting the CTRL terminal, shown as follow.

HT3163 在 CTRL 端输入不同电压值，能实现多种工作模式，详见下表。

Table 1 CTRL Terminal Configuration

Mode	CTRL Voltage		
	MIN	TYP	MAX
Spread spectrum off, Class D mode	2.3V	3.3V	5.5V
Spread spectrum on, Class D mode	1.7V	1.8V	1.9V
Class AB mode	1.4V	1.1V	0.8V
SD(Shutdown) Mode	0V	0V	0.5V

4.1 Startup, Shutdown

The HT3163 employs a shutdown mode of operation designed to reduce supply current (I_{DD}) to the absolute minimum level during periods of nonuse for power conservation. The CTRL terminal should be held low to shutdown the device to enter the low-current state.

HT3163 具有关断功能，以使芯片进入低功耗状态。当 CTRL 拉低时，芯片进入关断状态。

For a better power on and power-off pop performance, place the amplifier in the shutdown mode prior to delivering or removing the power supply.

上下电时，为减小 pop 声，在上、下电前，将功放关闭进入关断状态。

4.2 Spread Spectrum

The HT3163 device has built-in spread spectrum control of the oscillator frequency to improve EMI performance. The spread spectrum scheme is internally fixed and by setting the CTRL terminal.

HT3163 器件内置了扩频控制，以提高 EMI 性能。扩频方案内部固定，通过 CTRL 引脚设置开启。

4.3 Class AB

The HT3163 device can work in Class AB mode, which can avoid EMI issue that can be caused in Class D mode.

HT3163 器件可工作在 AB 类模式，可完全避免 EMI 等 D 类的干扰问题。

5 Anti-Clipping Function (ACF terminal)

HT3163 can work in different ACF modes and MUTE mode by setting the ACF terminal, shown as follow.

HT3163 可工作在 ACF 模式, 通过设置\SD 进入。

Table 2 ACF Terminal Configuration

Resistor on ACF pin to GND (R_{ACF})	Working Mode
$< 10k$	MUTE
33k	ACF1
56k	ACF2
100k	ACF3
$>200k$	ACF OFF

In ACF modes, HT3163 attenuates system gain to an appropriate value when an excessive input is applied, so as not to cause the clipping at the differential signal output. In this way, the output audio signal is controlled in order to obtain a maximum output level without distortion. And HT3163 also follows to the clips of the output waveform due to the decrease in the power-supply voltage.

在 ACF 模式下, 当电路检测到输入信号幅度过大而产生输出削顶时, HT3163 通过自动调整系统增益, 控制输出达到一种最大限度的无削顶失真功率水平, 由此大大改善了音质效果。此外, 当电源电压下降时, HT3163 也能自动衰减输出增益, 实现与 PVDD 下降值相匹配的最大限度无削顶输出水平。

The Attack time of ACF Function is a time interval until system gain falls to target attenuation gain $-3dB$ when a big enough signal input. And, the Release Time is a time from target attenuation gain to not working of ACF. The maximum attenuation gain is $18dB$.

ACF 模式下的启动时间 (Attack time) 指在突然输入足够大信号而产生输出削顶的条件下, ACF 启动对放大器的增益调整速率, 以 ms/dB 为单位; 释放时间 (Release time) 指产生削顶的输入条件消失, 增益退出衰减状态的速率, 以 ms/dB 为单位。HT3163 的最大衰减增益为 $18dB$ 。

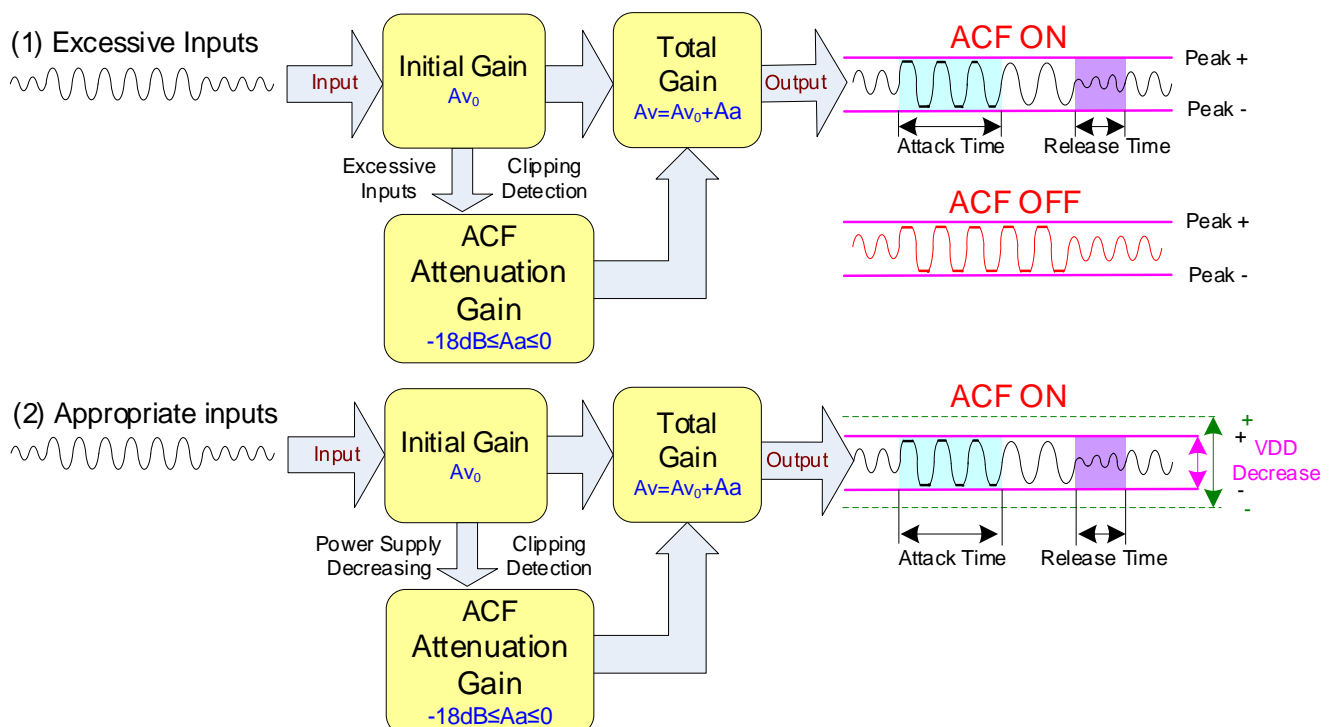

Figure 5 the ACF Function Operation Outline

Table 3 Attack time and Release time

ACF mode	Attack time	Release time
ACF3	45ms	100ms
ACF2	4ms	2.8s
ACF1	45ms	350ms

In MUTE mode, the differential output signal is muted, other internal modules are in normal operation, and the output stage becomes a high impedance state.

For a better pop performance, place the amplifier in MUTE mode prior to shutdown or enable the device.

6 Protection Function

HT3163 has the protection functions such as Over-Current Protection function, Thermal Protection function, Under-Voltage Protection .

(1) Over-current Protection function (OCP)

When a short circuit occurs between one output terminal and Ground, PVDD, or the other output, the over-current protection mode starts up. In the over current protection mode, the differential output terminal becomes a high impedance state. Once the short circuit conditions are eliminated, the over current protection mode can be cancelled automatically.

(2) Thermal Protection function (OTP)

When excessive high temperature of HT3163 (150 °C) is detected, the thermal protection mode starts up. In the thermal protection mode, the differential output terminal becomes a high impedance state.

(3) Under-Voltage Protection (UVP)

This is the function to establish the under-voltage protection mode when power supply becomes lower than the detection voltage V_{UVLL} (Typ 2.6V), and the protection mode is canceled when the power supply becomes higher than the threshold voltage V_{UVLH} (Typ 2.62V). In the under-voltage protection mode, the differential output pin becomes a high impedance state. HT3163 will start up within start-up time when the under-voltage protection mode is cancelled.

在静音模式下，输出无声，内部其他模块仍处于工作状态，输出端切换至高阻态。

为减小 pop 声，在 shutdown/使能前，将功放 MUTE。

HT3163 具有以下几种保护功能：输出端过流保护、片内过温保护、欠压保护。

(1) 过流保护

当检测到一输出端对电源、对地、或对另一输出端短路时，过流保护启动，输出端切换至高阻态，防止芯片烧毁损坏。短路情况消除后，芯片自动退出保护模式。

(2) 过温保护

当检测到芯片内温度超过 150 °C 时，过温保护启动，输出端切换至高阻态，防止芯片被热击穿损坏。

(3) 欠压保护

该功能是在当电源低于检测电压 V_{UVLL} (Typ 2.6V) 时建立欠压保护模式，当电源高于阈值电压 V_{UVLH} (Typ 2.62V) 时取消保护模式。在欠压保护模式下，输出端切换至高阻态。取消欠压保护模式后，HT3163 会在启动时间内启动。

PACKAGE OUTLINE

SPE (ESSOP10)

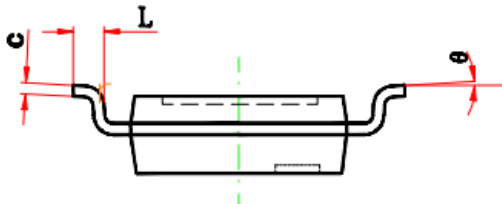
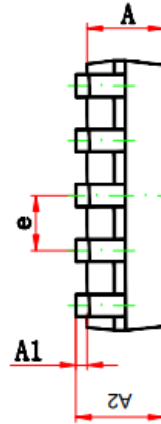
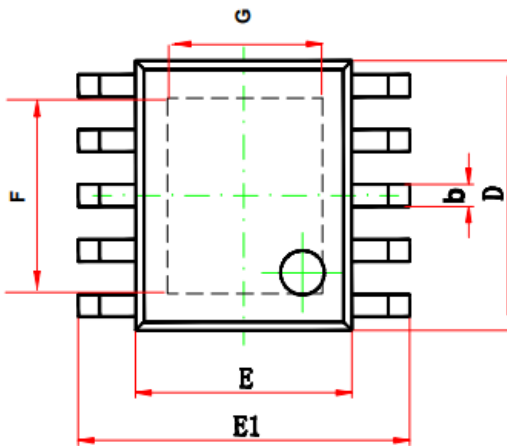

COMMON DIMENSIONS			
CUNITS MEASURE=MILLIMETER			
SYMBOL	MIN	MON	MAX
A	1.350	1.450	1.550
A1	0.0	0.04	0.08
A2	1.350	1.490	1.630
b	0.325	0.350	0.375
c	0.18	0.20	0.22
D	4.700	4.900	5.100
E	3.800	3.900	4.000
F	3.100	3.300	3.500
G	1.900	2.100	2.300
E1	5.800	6.000	6.200
e	1.000(BΣX)		
L	0.40	0.60	0.80
θ	0°	/	8°

IMPORTANT NOTICE**注意**

Heroic Electronic Technology (Jiaxing) Co., Ltd (HT) reserves the right to make corrections, modifications, enhancements, improvements, and other changes to its products and services at any time and to discontinue any products or services. Customers should obtain the latest relevant information before placing orders and should verify that such information is current and complete.

禾润电子科技（嘉兴）股份有限公司（以下简称HT）保留对产品、服务、文档的任何修改、更正、提高、改善和其他改变，或停止提供任何产品和服务的权利。客户在下单和生产前应确保所得到的信息是最新、最完整的。

HT assumes no liability for applications assistance or customer product design. Customers are responsible for their products and applications using HT components.

HT对相关应用的说明和协助以及客户产品的板级设计不承担任何责任。

HT products are not authorized for use in safety-critical applications (such as life support devices or systems) where a failure of the HT product would reasonably be expected to affect the safety or effectiveness of that devices or systems.

HT的产品并未授权用于诸如生命维持设备等安全性极高的应用中。

The information included herein is believed to be accurate and reliable. However, HT assumes no responsibility for its use; nor for any infringement of patents or other rights of third parties which may result from its use.

本文中的相关信息是精确和可靠的，但HT并不对其负责，也不对任何可能的专利和第三方权利的侵害负责。

Following are URLs and contacts where you can obtain information or supports on any HT products and application solutions:

下面是可以联系到我公司的相关链接和联系方式：

禾润电子科技（嘉兴）股份有限公司
Heroic Electronic Technology (Jiaxing) Co., Ltd.

地址：浙江省嘉兴市凌公塘路3339号JRC大厦A座三层

Add: A 3rd floor, JRC Building, No. 3339, LingGongTang Road, Jiaxing, Zhejiang Province

Sales: 0573-82585539, sales@heroic.com.cn

Support: 0573-82586151, support@heroic.com.cn

Fax: 0573-82585078

Website: www.heroic.com.cn; wap.heroic.com.cn

Wechat MP: HEROIC_JX

请及时关注禾润官方微信公众号，随时获取最新产品信息和技术资料！

