

Aluminum Electrolytic Capacitors Power Eurodin Printed Wiring

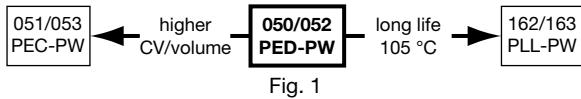


Fig. 1

| QUICK REFERENCE DATA | | |
|---|-------------------------|------------------|
| DESCRIPTION | VALUE | |
| | 050 | 052 |
| Nominal case size (∅ D x L in mm) | 25 x 30 to 40 x 100 | |
| Rated capacitance range (E6 series), C _R | 470 µF to 68 000 µF | 47 µF to 1000 µF |
| Tolerance on C _R | -10 % to +30 % | |
| Rated voltage range, U _R | 10 V to 100 V | 250 V to 400 V |
| Category temperature range | -40 °C to +85 °C | |
| Endurance test at 85 °C | 5000 h | |
| Useful life at 85 °C | 15 000 h | |
| Useful life at 40 °C, 1.4 x I _R applied | 250 000 h | |
| Shelf life at 0 V, 85 °C | 500 h | |
| Based on sectional specification | IEC 60384-4 / EN 130300 | |
| Climatic category IEC 60068 | 40 / 085 / 56 | |

FEATURES

- Very long useful life: 15 000 h at 85 °C
- Low ESR, high ripple current capability
- High resistance to shock and vibration
- Polarized aluminum electrolytic capacitors, non-solid electrolyte
- Large types, cylindrical aluminum case, insulated with a blue sleeve
- Provided with keyed polarity
- 050 series also available in solder-lug (SL) versions
- Material categorization: for definitions of compliance please see www.vishay.com/doc?99912


**RoHS
COMPLIANT**

APPLICATIONS

- Computer, telecommunication, and industrial systems
- Smoothing and filtering
- Standard and switched mode power supplies
- Energy storage in pulse systems

MARKING

The capacitors are marked (where possible) with the following information:

- Rated capacitance (in µF)
- Tolerance on rated capacitance, code letter in accordance with IEC 60062 (Q for -10 % / +30 %)
- Rated voltage (in V)
- Date code (YYWW or in 2 digits according to IEC 60062)
- Name of manufacturer
- Code for factory of origin
- Polarity of the terminals and “-” sign to indicate the negative terminal, visible from the top and / or side of the capacitor
- Code number
- Climatic category in accordance with IEC 60068

| SELECTION CHART FOR C _R , U _R , AND RELEVANT NOMINAL CASE SIZES FOR 050 SERIES (∅ D x L in mm) | | | | | | |
|--|--------------------|----------|----------|----------|----------|----------|
| C _R (µF) | U _R (V) | | | | | |
| | 10 | 16 | 25 | 40 | 63 | 100 |
| 470 | - | - | - | - | - | 25 x 30 |
| 680 | - | - | - | - | - | 25 x 40 |
| 1000 | - | - | - | - | 25 x 30 | 30 x 40 |
| 1500 | - | - | - | 25 x 30 | 25 x 40 | 35 x 40 |
| 2200 | - | - | 25 x 30 | 25 x 40 | 30 x 40 | 35 x 50 |
| 3300 | - | 25 x 30 | 25 x 40 | 30 x 40 | 35 x 40 | 40 x 50 |
| 4700 | 25 x 30 | 25 x 40 | 30 x 40 | 35 x 40 | 35 x 50 | 40 x 70 |
| 6800 | 25 x 40 | 30 x 40 | 35 x 40 | 35 x 50 | 40 x 50 | 40 x 100 |
| 10 000 | 30 x 40 | 35 x 40 | 35 x 50 | 40 x 50 | 40 x 70 | - |
| 15 000 | 35 x 40 | 35 x 50 | 40 x 50 | 40 x 70 | 40 x 100 | - |
| 22 000 | 35 x 50 | 40 x 50 | 40 x 70 | 40 x 100 | - | - |
| 33 000 | 40 x 50 | 40 x 70 | 40 x 100 | - | - | - |
| 47 000 | 40 x 70 | 40 x 100 | - | - | - | - |
| 68 000 | 40 x 100 | - | - | - | - | - |

| SELECTION CHART FOR C_R, U_R, AND RELEVANT NOMINAL CASE SIZES FOR 052 SERIES ($\varnothing D \times L$ in mm) | | | |
|---|-----------|---------|----------|
| C_R (μF) | U_R (V) | | |
| | 250 | 385 | 400 |
| 47 | - | 25 x 30 | 25 x 30 |
| 68 | - | 25 x 40 | 25 x 40 |
| 100 | 25 x 30 | 30 x 40 | 30 x 40 |
| 150 | 25 x 40 | 35 x 40 | 35 x 40 |
| 220 | 30 x 40 | 35 x 50 | 35 x 50 |
| | - | 40 x 40 | 40 x 40 |
| 330 | 35 x 40 | 40 x 50 | 40 x 50 |
| 470 | 35 x 50 | 40 x 70 | 40 x 70 |
| | 40 x 40 | - | - |
| 680 | 40 x 50 | - | 40 x 100 |
| 1000 | 40 x 70 | - | - |

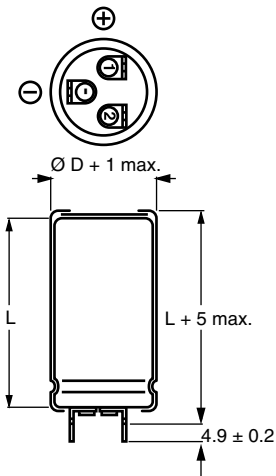
DIMENSIONS in millimeters AND AVAILABLE FORMS

 Case $\varnothing D = 25$ mm

Fig. 2 - Printed wiring pin version

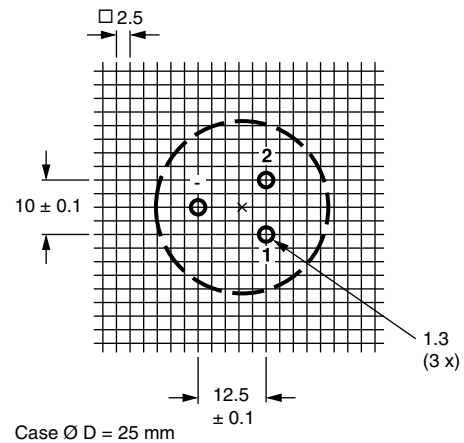


Fig. 3 - Mounting hole diagram viewed from component side

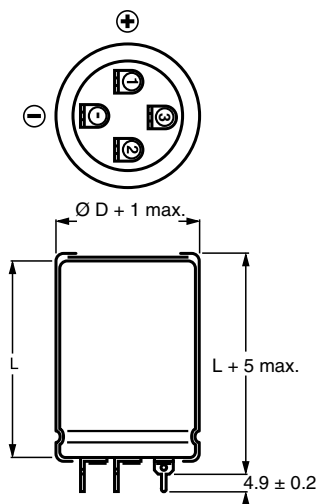

 Case $\varnothing D = 30$ mm

Fig. 4 - Printed wiring pin version

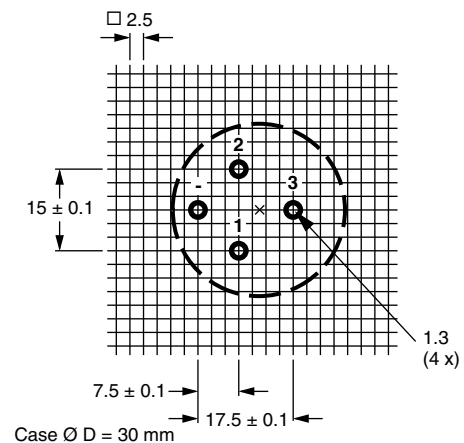


Fig. 5 - Mounting hole diagram viewed from component side



Fig. 6 - Printed wiring pin version



Fig. 7 - Mounting hole diagram viewed from component side



Fig. 8 - Printed wiring pin version



Fig. 9 - Mounting hole diagram viewed from component side



Fig. 10 - Solder-lug versions (SL): only available in 050 series

MOUNTING

When a number of capacitors are connected in a bank, they must not be closer together than 15 mm, when no derating of ripple current and / or temperature is applied.

Pin number 1 is the positive terminal. Pin “-” is the negative terminal.

Pin numbers 2, 3 and 4 (if present) should be free from the electrical circuit or connected to the minus terminal.



Table 1

| DIMENSIONS in millimeters, MASS, AND PACKAGING QUANTITIES | | | | | | |
|---|---------------------|----------------------------------|----------------------------------|-------------|---|---------------------------------------|
| NOMINAL CASE SIZE Ø D x L | Ø D _{max.} | L _{max.} SL VERSIONS | L _{max.} PW VERSIONS | MASS (g) | PACKAGING QUANTITIES (units per box) | CARDBOARD BOX DIMENSIONS L x W x H |
| 25 x 30 | 26 | 32 | 35 | ≈ 24 | 100 | 290 x 280 x 50 |
| 25 x 40 | 26 | 42 | 45 | ≈ 28 | 100 | 290 x 280 x 60 |
| 30 x 40 | 31 | 42 | 45 | ≈ 38 | 100 | 340 x 330 x 60 |
| 35 x 40 | 36 | 42 | 45 | ≈ 51 | 50 | 390 x 198 x 60 |
| 35 x 50 | 36 | 52 | 55 | ≈ 66 | 50 | 390 x 198 x 70 |
| 40 x 40 ⁽¹⁾ | 41 | - | 45 | ≈ 78 | 50 | 440 x 223 x 60 |
| 40 x 50 | 41 | 52 | 55 | ≈ 82 | 50 | 440 x 223 x 70 |
| 40 x 70 | 41 | 72 | 75 | ≈ 110 | 25 | 230 x 230 x 90 |
| 40 x 100 | 41 | 102 | 105 | ≈ 176 | 25 | 230 x 230 x 120 |

Note

⁽¹⁾ Not available in SL versions

| ELECTRICAL DATA | |
|-----------------|---|
| SYMBOL | DESCRIPTION |
| C _R | Rated capacitance at 100 Hz |
| I _R | Rated RMS ripple current at 100 Hz, 85 °C or at 20 kHz, 70 °C |
| I _{L1} | Max. leakage current after 1 min at U _R |
| I _{L5} | Max. leakage current after 5 min at U _R |
| ESR | Max. equivalent series resistance at 100 Hz |
| Z | Max. impedance at 10 kHz |

Note

- Unless otherwise specified, all electrical values in tables 2 and 3 apply at T_{amb} = 20 °C, P = 86 kPa to 106 kPa, RH = 45 % to 75 %

ORDERING EXAMPLE

Electrolytic capacitor 050 series
 10 000 µF / 25 V; -10 % / +30 %
 Nominal case size: Ø 35 mm x 50 mm; PW version
 Ordering code: MAL2 050 56103 E3
 Former 12NC: 2222 050 56103

Table 2

| ELECTRICAL DATA AND ORDERING INFORMATION FOR 050 SERIES | | | | | | | | | | |
|---|----------------------------------|--------------------------------------|--|--|----------------------------------|----------------------------------|-----------------------|---------------------|----------------------------------|----------------------------------|
| U _R (V) | C _R 100 Hz (µF) | NOMINAL CASE SIZE Ø D x L (mm) | I _R 100 Hz 85 °C (A) | I _R 20 kHz 70 °C (A) | I _{L1} 1 min (mA) | I _{L5} 5 min (mA) | ESR 100 Hz (mΩ) | Z 10 kHz (mΩ) | ORDERING CODE SL MAL2050..... | ORDERING CODE PW MAL2050..... |
| 10 | 4700 | 25 x 30 | 2.4 | 4.6 | 0.28 | 0.10 | 74 | 50 | 14472E3 | 54472E3 |
| | 6800 | 25 x 40 | 3.2 | 6.1 | 0.41 | 0.14 | 51 | 37 | 14682E3 | 54682E3 |
| | 10 000 | 30 x 40 | 3.8 | 7.2 | 0.60 | 0.20 | 39 | 29 | 14103E3 | 54103E3 |
| | 15 000 | 35 x 40 | 4.1 | 7.8 | 0.90 | 0.30 | 35 | 26 | 14153E3 | 54153E3 |
| | 22 000 | 35 x 50 | 5.0 | 9.5 | 1.32 | 0.44 | 27 | 21 | 14223E3 | 54223E3 |
| | 22 000 | 40 x 40 | 4.2 | 8.0 | 1.32 | 0.44 | 36 | 27 | n/a | 44223E3 |
| | 33 000 | 40 x 50 | 5.0 | 9.5 | 1.98 | 0.66 | 29 | 22 | 14333E3 | 54333E3 |
| | 47 000 | 40 x 70 | 6.8 | 12.9 | 2.82 | 0.94 | 20 | 17 | 14473E3 | 54473E3 |
| | 68 000 | 40 x 100 | 9.2 | 17.5 | 4.08 | 1.36 | 15 | 14 | 14683E3 | 54683E3 |



| ELECTRICAL DATA AND ORDERING INFORMATION FOR 050 SERIES | | | | | | | | | | |
|---|----------------------------------|---|--|--|----------------------------------|----------------------------------|-----------------------|---------------------|-------------------------------------|-------------------------------------|
| U _R (V) | C _R 100 Hz (μF) | NOMINAL CASE SIZE Ø D x L (mm) | I _R 100 Hz 85 °C (A) | I _R 20 kHz 70 °C (A) | I _{L1} 1 min (mA) | I _{L5} 5 min (mA) | ESR 100 Hz (mΩ) | Z 10 kHz (mΩ) | ORDERING CODE SL MAL2050..... | ORDERING CODE PW MAL2050..... |
| 16 | 3300 | 25 x 30 | 2.4 | 4.6 | 0.32 | 0.11 | 75 | 50 | 15332E3 | 55332E3 |
| | 4700 | 25 x 40 | 3.1 | 5.9 | 0.45 | 0.15 | 52 | 37 | 15472E3 | 55472E3 |
| | 6800 | 30 x 40 | 3.7 | 7.0 | 0.65 | 0.22 | 40 | 30 | 15682E3 | 55682E3 |
| | 10 000 | 35 x 40 | 4.1 | 7.8 | 0.96 | 0.32 | 36 | 27 | 15103E3 | 55103E3 |
| | 15 000 | 35 x 50 | 5.0 | 9.5 | 1.44 | 0.48 | 28 | 21 | 15153E3 | 55153E3 |
| | 15 000 | 40 x 40 | 4.2 | 8.0 | 1.44 | 0.48 | 36 | 27 | n/a | 45153E3 |
| | 22 000 | 40 x 50 | 5.0 | 9.5 | 2.12 | 0.71 | 29 | 22 | 15223E3 | 55223E3 |
| | 33 000 | 40 x 70 | 6.7 | 12.7 | 3.17 | 1.06 | 20 | 17 | 15333E3 | 55333E3 |
| | 47 000 | 40 x 100 | 9.1 | 17.3 | 4.51 | 1.51 | 15 | 14 | 15473E3 | 55473E3 |
| 25 | 2200 | 25 x 30 | 2.3 | 4.4 | 0.33 | 0.11 | 78 | 52 | 16222E3 | 56222E3 |
| | 3300 | 25 x 40 | 3.1 | 5.9 | 0.49 | 0.17 | 53 | 38 | 16332E3 | 56332E3 |
| | 4700 | 30 x 40 | 3.7 | 7.0 | 0.70 | 0.24 | 42 | 31 | 16472E3 | 56472E3 |
| | 6800 | 35 x 40 | 4.1 | 7.8 | 1.02 | 0.34 | 37 | 28 | 16682E3 | 56682E3 |
| | 10 000 | 35 x 50 | 5.0 | 9.5 | 1.50 | 0.50 | 28 | 21 | 16103E3 | 56103E3 |
| | 10 000 | 40 x 40 | 4.2 | 8.0 | 1.50 | 0.50 | 36 | 27 | n/a | 46103E3 |
| | 15 000 | 40 x 50 | 5.0 | 9.5 | 2.25 | 0.75 | 29 | 22 | 16153E3 | 56153E3 |
| | 22 000 | 40 x 70 | 6.8 | 12.9 | 3.30 | 1.10 | 20 | 17 | 16223E3 | 56223E3 |
| | 33 000 | 40 x 100 | 9.2 | 17.5 | 4.95 | 1.65 | 15 | 14 | 16333E3 | 56333E3 |
| 40 | 1500 | 25 x 30 | 2.0 | 3.8 | 0.36 | 0.12 | 112 | 68 | 17152E3 | 57152E3 |
| | 2200 | 25 x 40 | 2.7 | 5.1 | 0.53 | 0.18 | 76 | 51 | 17222E3 | 57222E3 |
| | 3300 | 30 x 40 | 3.3 | 6.3 | 0.79 | 0.27 | 57 | 41 | 17332E3 | 57332E3 |
| | 4700 | 35 x 40 | 3.8 | 7.2 | 1.13 | 0.38 | 48 | 35 | 17472E3 | 57472E3 |
| | 6800 | 35 x 50 | 4.7 | 8.9 | 1.64 | 0.55 | 36 | 27 | 17682E3 | 57682E3 |
| | 6800 | 40 x 40 | 4.1 | 7.8 | 1.64 | 0.55 | 45 | 33 | n/a | 47682E3 |
| | 10 000 | 40 x 50 | 4.9 | 9.3 | 2.40 | 0.80 | 35 | 27 | 17103E3 | 57103E3 |
| | 15 000 | 40 x 70 | 6.6 | 12.5 | 3.60 | 1.20 | 25 | 20 | 17153E3 | 57153E3 |
| | 22 000 | 40 x 100 | 9.0 | 17.1 | 5.28 | 1.76 | 18 | 16 | 17223E3 | 57223E3 |
| 63 | 1000 | 25 x 30 | 1.8 | 3.4 | 0.38 | 0.13 | 122 | 74 | 18102E3 | 58102E3 |
| | 1500 | 25 x 40 | 2.5 | 4.7 | 0.57 | 0.19 | 83 | 54 | 18152E3 | 58152E3 |
| | 2200 | 30 x 40 | 3.1 | 5.9 | 0.83 | 0.28 | 57 | 41 | 18222E3 | 58222E3 |
| | 3300 | 35 x 40 | 3.6 | 6.8 | 1.25 | 0.42 | 48 | 35 | 18332E3 | 58332E3 |
| | 4700 | 35 x 50 | 4.4 | 8.3 | 1.78 | 0.60 | 36 | 27 | 18472E3 | 58472E3 |
| | 4700 | 40 x 40 | 3.8 | 7.2 | 1.78 | 0.60 | 45 | 33 | n/a | 48472E3 |
| | 6800 | 40 x 50 | 4.7 | 8.9 | 2.57 | 0.86 | 35 | 27 | 18682E3 | 58682E3 |
| | 10 000 | 40 x 70 | 6.2 | 11.8 | 3.78 | 1.26 | 25 | 20 | 18103E3 | 58103E3 |
| | 15 000 | 40 x 100 | 8.5 | 16.1 | 5.67 | 1.89 | 18 | 16 | 18153E3 | 58153E3 |
| 100 | 470 | 25 x 30 | 1.4 | 2.7 | 0.28 | 0.10 | 247 | 172 | 19471E3 | 59471E3 |
| | 680 | 25 x 40 | 1.9 | 3.6 | 0.41 | 0.14 | 170 | 116 | 19681E3 | 59681E3 |
| | 1000 | 30 x 40 | 2.5 | 4.7 | 0.60 | 0.20 | 123 | 88 | 19102E3 | 59102E3 |
| | 1500 | 35 x 40 | 3.1 | 5.8 | 0.90 | 0.30 | 94 | 71 | 19152E3 | 59152E3 |
| | 2200 | 35 x 50 | 3.9 | 7.4 | 1.32 | 0.44 | 69 | 55 | 19222E3 | 59222E3 |
| | 2200 | 40 x 40 | 3.6 | 6.8 | 1.32 | 0.44 | 81 | 65 | n/a | 49222E3 |
| | 3300 | 40 x 50 | 4.6 | 8.7 | 1.98 | 0.66 | 59 | 48 | 19332E3 | 59332E3 |
| | 4700 | 40 x 70 | 6.2 | 11.7 | 2.82 | 0.94 | 42 | 36 | 19472E3 | 59472E3 |
| | 6800 | 40 x 100 | 8.2 | 15.5 | 4.08 | 1.36 | 32 | 28 | 19682E3 | 59682E3 |



Table 3

| ELECTRICAL DATA AND ORDERING INFORMATION FOR 052 SERIES | | | | | | | | | |
|---|----------------------------------|---|--|--|----------------------------------|----------------------------------|-----------------------|---------------------|----------------------------------|
| U _R (V) | C _R 100 Hz (µF) | NOMINAL CASE SIZE Ø D x L (mm) | I _R 100 Hz 85 °C (A) | I _R 20 kHz 70 °C (A) | I _{L1} 1 min (mA) | I _{L5} 5 min (mA) | ESR 100 Hz (mΩ) | Z 10 kHz (mΩ) | ORDERING CODE MAL2052..... |
| 250 | 100 | 25 x 30 | 0.6 | 1.15 | 0.15 | 0.05 | 1800 | 1300 | 53101E3 |
| | 150 | 25 x 40 | 0.8 | 1.5 | 0.23 | 0.08 | 1100 | 850 | 53151E3 |
| | 220 | 30 x 40 | 1.0 | 1.9 | 0.33 | 0.11 | 750 | 550 | 53221E3 |
| | 330 | 35 x 40 | 1.4 | 2.65 | 0.49 | 0.17 | 500 | 400 | 53331E3 |
| | 470 | 35 x 50 | 1.8 | 3.4 | 0.70 | 0.24 | 360 | 290 | 53471E3 |
| | 470 | 40 x 40 | 1.8 | 3.4 | 0.70 | 0.24 | 420 | 350 | 43471E3 |
| | 680 | 40 x 50 | 2.3 | 4.4 | 1.02 | 0.34 | 250 | 190 | 53681E3 |
| | 1000 | 40 x 70 | 3.0 | 5.7 | 1.50 | 0.50 | 170 | 140 | 53102E3 |
| 385 | 47 | 25 x 30 | 0.5 | 0.94 | 0.11 | 0.04 | 2370 | 1550 | 58479E3 |
| | 68 | 25 x 40 | 0.67 | 1.27 | 0.16 | 0.06 | 1640 | 1100 | 58689E3 |
| | 100 | 30 x 40 | 0.84 | 1.59 | 0.23 | 0.08 | 1275 | 950 | 58101E3 |
| | 150 | 35 x 40 | 1.13 | 2.14 | 0.34 | 0.11 | 850 | 635 | 58151E3 |
| | 220 | 35 x 50 | 1.48 | 2.8 | 0.50 | 0.17 | 580 | 430 | 58221E3 |
| | 220 | 40 x 40 | 1.48 | 2.8 | 0.50 | 0.17 | 580 | 430 | 48221E3 |
| | 330 | 40 x 50 | 1.97 | 3.73 | 0.75 | 0.25 | 385 | 300 | 58331E3 |
| | 470 | 40 x 70 | 2.7 | 5.11 | 1.06 | 0.36 | 270 | 215 | 58471E3 |
| 400 | 47 | 25 x 30 | 0.47 | 0.89 | 0.11 | 0.04 | 2700 | 2125 | 56479E3 |
| | 68 | 25 x 40 | 0.63 | 1.29 | 0.16 | 0.06 | 1875 | 1470 | 56689E3 |
| | 100 | 30 x 40 | 0.84 | 1.59 | 0.24 | 0.08 | 1275 | 1000 | 56101E3 |
| | 150 | 35 x 40 | 1.13 | 2.14 | 0.36 | 0.12 | 850 | 665 | 56151E3 |
| | 220 | 35 x 50 | 1.41 | 2.67 | 0.52 | 0.17 | 650 | 450 | 56221E3 |
| | 220 | 40 x 40 | 1.41 | 2.67 | 0.52 | 0.17 | 650 | 450 | 46221E3 |
| | 330 | 40 x 50 | 1.86 | 3.52 | 0.79 | 0.26 | 435 | 315 | 56331E3 |
| | 470 | 40 x 70 | 2.54 | 4.81 | 1.12 | 0.37 | 305 | 225 | 56471E3 |
| | 680 | 40 x 100 | 3.56 | 6.75 | 1.63 | 0.54 | 210 | 155 | 56681E3 |

| ADDITIONAL ELECTRICAL DATA | | |
|------------------------------------|-------------------------------|--|
| PARAMETER | CONDITIONS | VALUE |
| Voltage | | |
| Surge voltage | ≤ 250 V versions | U _s = 1.15 x U _R |
| | ≥ 385 V versions | U _s = 1.1 x U _R |
| Reverse voltage | | U _{rev} ≤ 1 V |
| Current | | |
| Leakage current | After 1 min at U _R | I _{L1} ≤ 0.006 C _R x U _R + 4 µA |
| | After 5 min at U _R | I _{L5} ≤ 0.002 C _R x U _R + 4 µA |
| Inductance | | |
| Equivalent series inductance (ESL) | Case Ø D = 25 mm | Max. 25 nH |
| | Case Ø D = 30 mm and 35 mm | Max. 30 nH |
| | Case Ø D = 40 mm | Max. 35 nH |

CAPACITANCE (C)



Fig. 11 - Typical multiplier of capacitance as a function of ambient temperature

EQUIVALENT SERIES RESISTANCE (ESR)

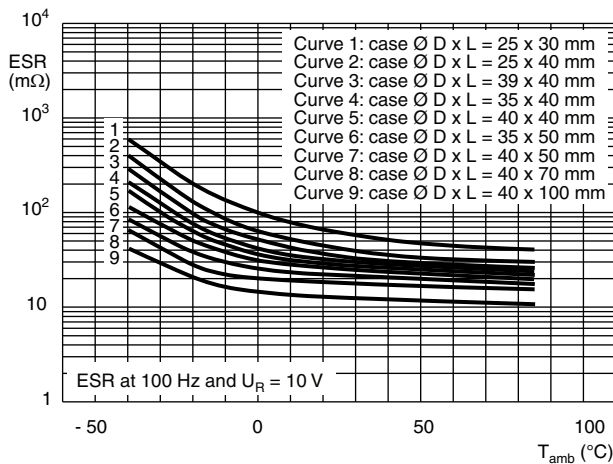


Fig. 12 - Typical ESR as a function of temperature

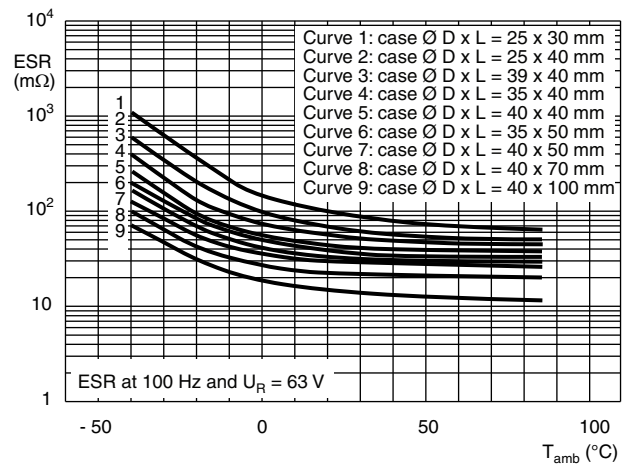


Fig. 13 - Typical ESR as a function of temperature

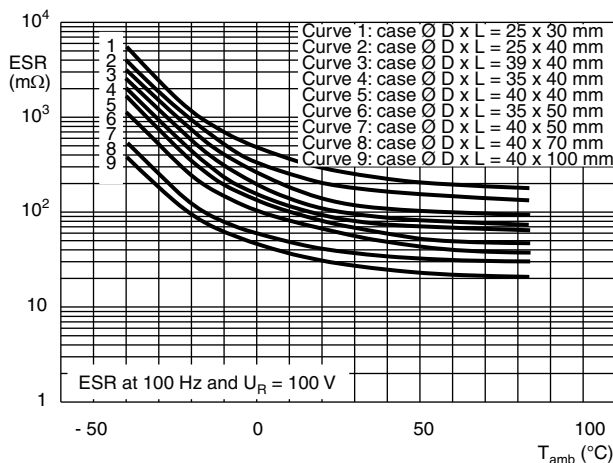


Fig. 14 - Typical ESR as a function of temperature

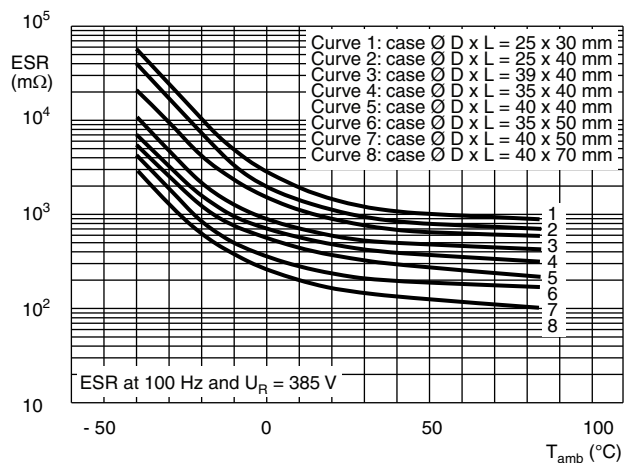


Fig. 15 - Typical ESR as a function of temperature



IMPEDANCE (Z)

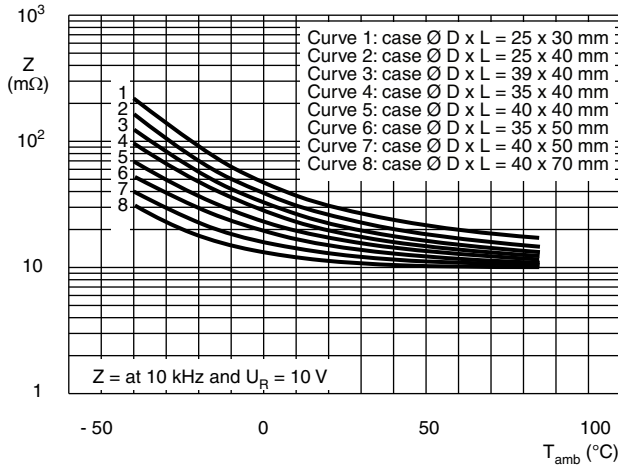


Fig. 16 - Typical impedance as a function of temperature

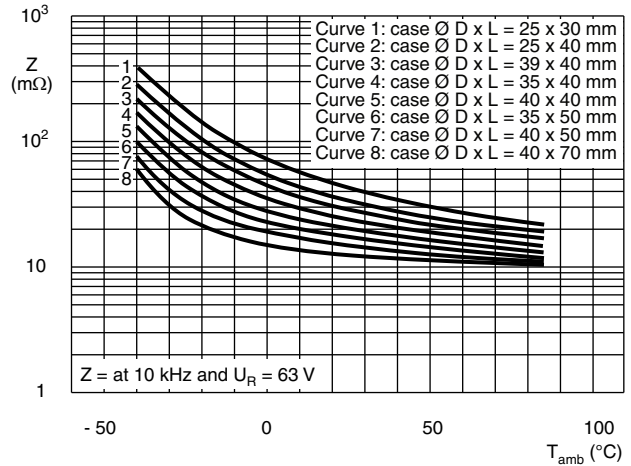


Fig. 17 - Typical impedance as a function of temperature

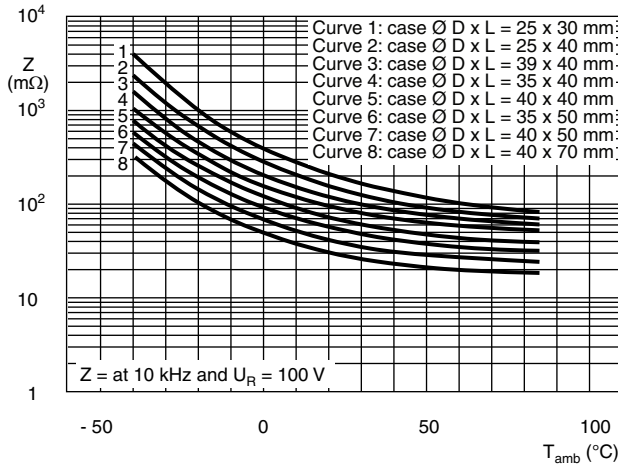


Fig. 18 - Typical impedance as a function of temperature

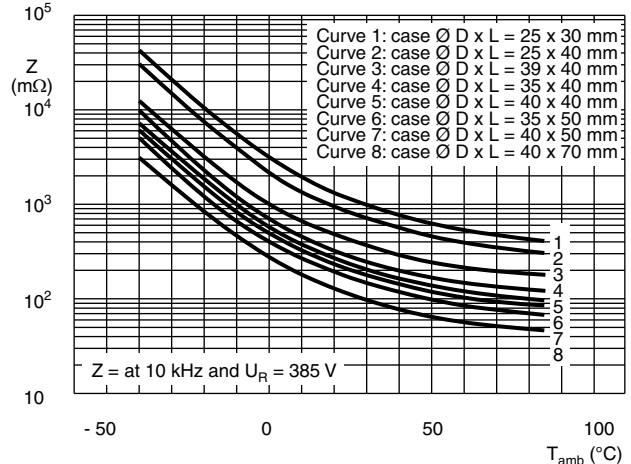


Fig. 19 - Typical impedance as a function of temperature

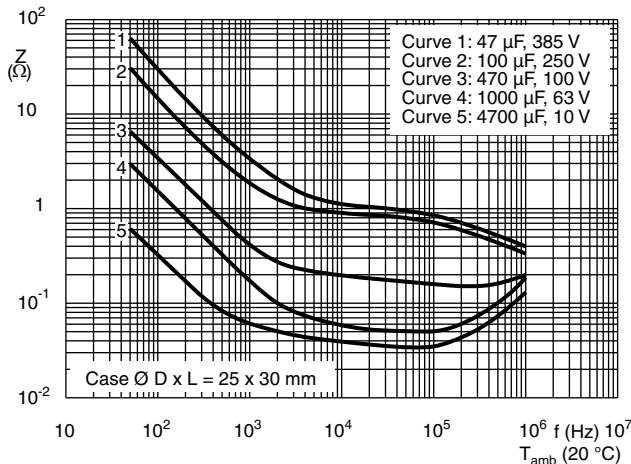


Fig. 20 - Typical impedance as a function of temperature

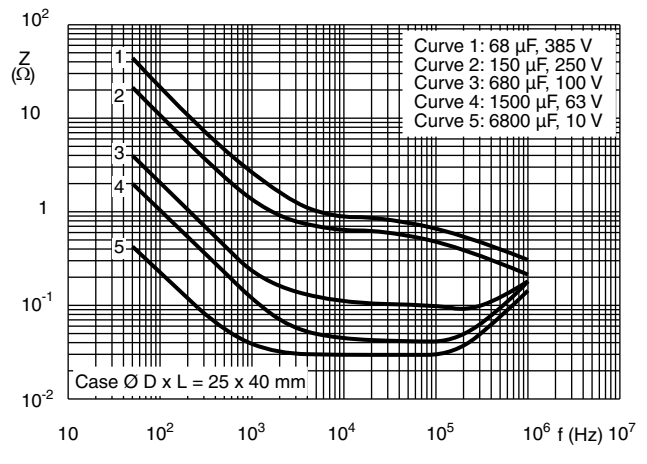


Fig. 21 - Typical impedance as a function of temperature



Fig. 22 - Typical impedance as a function of frequency

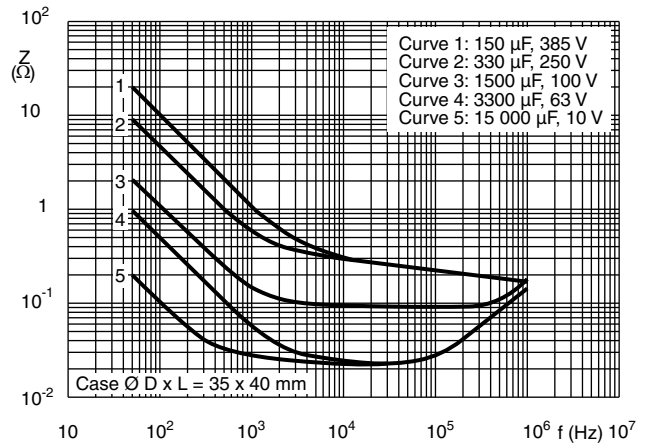


Fig. 23 - Typical impedance as a function of frequency

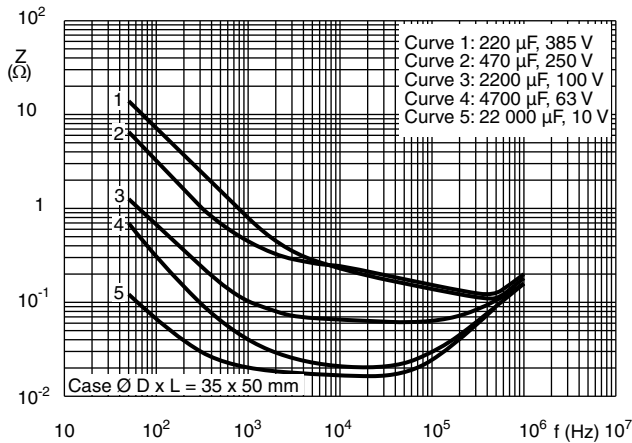


Fig. 24 - Typical impedance as a function of frequency

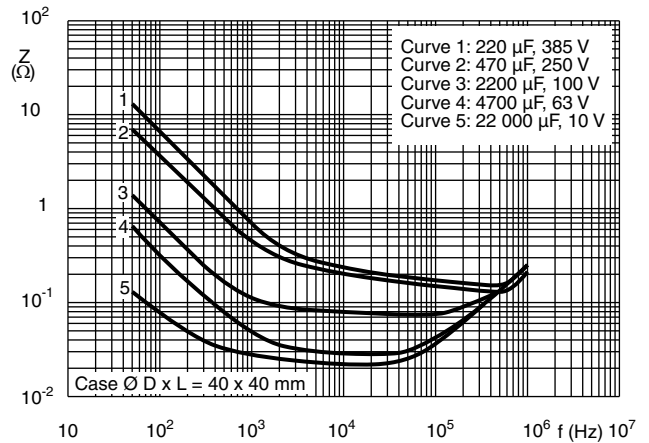


Fig. 25 - Typical impedance as a function of frequency

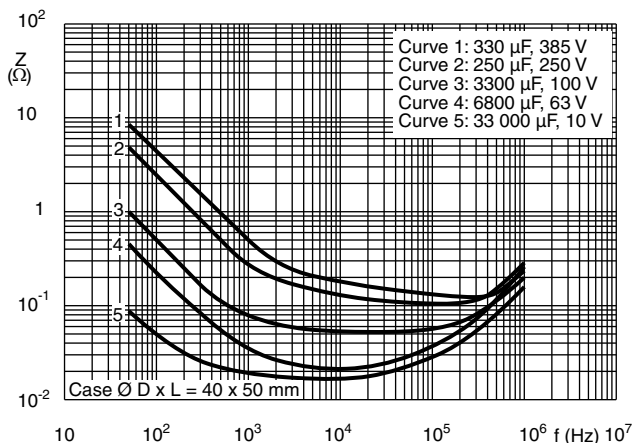


Fig. 26 - Typical impedance as a function of frequency

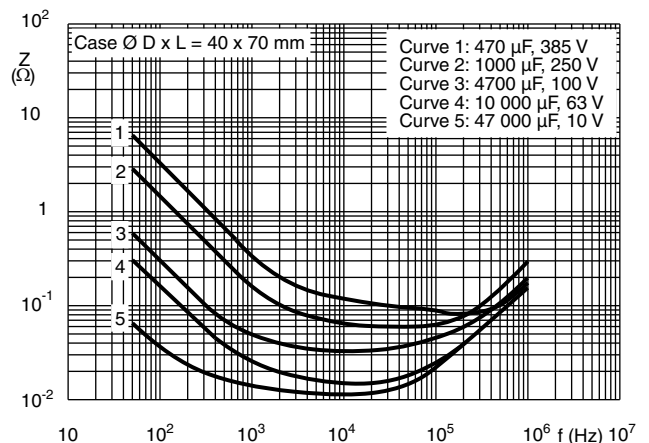


Fig. 27 - Typical impedance as a function of frequency

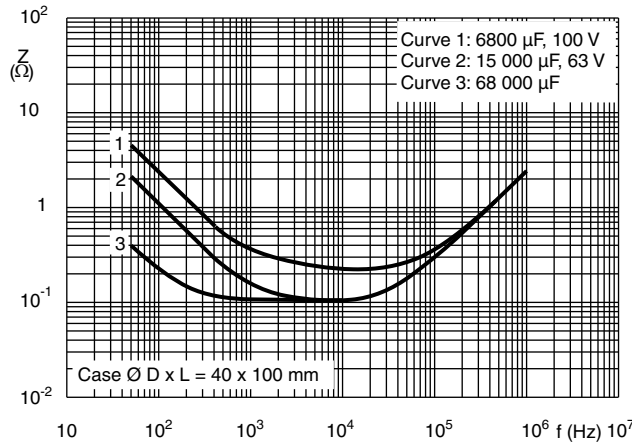


Fig. 28 - Typical impedance as a function of frequency

RIPPLE CURRENT AND USEFUL LIFE

Table 4

| ENDURANCE TEST DURATION AND USEFUL LIFE | |
|---|--------------------------|
| ENDURANCE AT 85 °C (h) | USEFUL LIFE AT 85 °C (h) |
| 5000 | 15 000 |

Note

- Multiplier of useful life code: MGA453



I_A = Actual ripple current
 I_R = Rated ripple current at 100 Hz and 85 °C
 (1) Useful life at 85 °C and I_R applied: 15 000 h

Fig. 29 - Multiplier of useful life as a function of ambient temperature and ripple current load



Table 5

| MULTIPLIER OF RIPPLE CURRENT (I_R) AS A FUNCTION OF FREQUENCY | | | | | |
|---|------|------|------|------|-------------|
| FREQUENCY (Hz) | | | | | |
| 50 | 100 | 200 | 400 | 1000 | ≥ 2000 |
| I_R MULTIPLIER | | | | | |
| 0.83 | 1.00 | 1.10 | 1.15 | 1.19 | 1.20 |

Table 6

| TEST PROCEDURES AND REQUIREMENTS | | | |
|--|--|---|---|
| TEST | | PROCEDURE (QUICK REFERENCE) | REQUIREMENTS |
| NAME OF TEST | REFERENCE | | |
| Endurance | IEC 60384-4 / EN 130300 subclause 4.13 | $T_{amb} = 85\text{ }^\circ\text{C}$; U_R applied; 5000 h | $U_R \leq 100\text{ V}$; $\Delta C/C: \pm 15\%$ $U_R > 100\text{ V}$; $\Delta C/C: \pm 10\%$ $ESR \leq 1.3 \times \text{spec. limit}$ $Z \leq 2 \times \text{spec. limit}$ $I_{L5} \leq \text{spec. limit}$ |
| Useful life | CECC 30301 subclause 1.8.1 | $T_{amb} = 85\text{ }^\circ\text{C}$; U_R and I_R applied; 15 000 h | $U_R \leq 100\text{ V}$; $\Delta C/C: \pm 45\%$ $U_R > 100\text{ V}$; $\Delta C/C: \pm 30\%$ $ESR \leq 3 \times \text{spec. limit}$ $Z \leq 3 \times \text{spec. limit}$ $I_{L5} \leq \text{spec. limit}$ no short or open circuit, no visible damage total failure percentage: $U_R \leq 100\text{ V}: \leq 1\%$; $U_R > 100\text{ V}: \leq 3\%$ |
| Shelf life (storage at high temperature) | IEC 60384-4 / EN 130300 subclause 4.17 | $T_{amb} = 85\text{ }^\circ\text{C}$; no voltage applied; 500 h After test: U_R to be applied for 30 min, 24 h to 48 h before measurement | $\Delta C/C: \pm 10\%$ $ESR \leq 1.2 \times \text{spec. limit}$ $I_{L5} \leq 2 \times \text{spec. limit}$ |

Statements about product lifetime are based on calculations and internal testing. They should only be interpreted as estimations. Also due to external factors, the lifetime in the field application may deviate from the calculated lifetime. In general, nothing stated herein shall be construed as a guarantee of durability.



Disclaimer

ALL PRODUCT, PRODUCT SPECIFICATIONS AND DATA ARE SUBJECT TO CHANGE WITHOUT NOTICE TO IMPROVE RELIABILITY, FUNCTION OR DESIGN OR OTHERWISE.

Vishay Intertechnology, Inc., its affiliates, agents, and employees, and all persons acting on its or their behalf (collectively, "Vishay"), disclaim any and all liability for any errors, inaccuracies or incompleteness contained in any datasheet or in any other disclosure relating to any product.

Vishay makes no warranty, representation or guarantee regarding the suitability of the products for any particular purpose or the continuing production of any product. To the maximum extent permitted by applicable law, Vishay disclaims (i) any and all liability arising out of the application or use of any product, (ii) any and all liability, including without limitation special, consequential or incidental damages, and (iii) any and all implied warranties, including warranties of fitness for particular purpose, non-infringement and merchantability.

Statements regarding the suitability of products for certain types of applications are based on Vishay's knowledge of typical requirements that are often placed on Vishay products in generic applications. Such statements are not binding statements about the suitability of products for a particular application. It is the customer's responsibility to validate that a particular product with the properties described in the product specification is suitable for use in a particular application. Parameters provided in datasheets and / or specifications may vary in different applications and performance may vary over time. All operating parameters, including typical parameters, must be validated for each customer application by the customer's technical experts. Product specifications do not expand or otherwise modify Vishay's terms and conditions of purchase, including but not limited to the warranty expressed therein.

Hyperlinks included in this datasheet may direct users to third-party websites. These links are provided as a convenience and for informational purposes only. Inclusion of these hyperlinks does not constitute an endorsement or an approval by Vishay of any of the products, services or opinions of the corporation, organization or individual associated with the third-party website. Vishay disclaims any and all liability and bears no responsibility for the accuracy, legality or content of the third-party website or for that of subsequent links.

Except as expressly indicated in writing, Vishay products are not designed for use in medical, life-saving, or life-sustaining applications or for any other application in which the failure of the Vishay product could result in personal injury or death. Customers using or selling Vishay products not expressly indicated for use in such applications do so at their own risk. Please contact authorized Vishay personnel to obtain written terms and conditions regarding products designed for such applications.

No license, express or implied, by estoppel or otherwise, to any intellectual property rights is granted by this document or by any conduct of Vishay. Product names and markings noted herein may be trademarks of their respective owners.