



Chengdu Ebyte Electronic Technology Co.,Ltd

Wireless Modem

User Manual



E96-DTU (433L20-485)

All rights to interpret and modify this manual belong to
Chengdu Ebyte Electronic Technology Co., Ltd.

Contents

Disclaimer and Copyright Notice.....	3
1. Introduction.....	1
1.1 Brief Introduction.....	1
1.2 Features.....	1
1.3 Quick Star.....	2
1.4 Size.....	4
2. Interface Description.....	5
2.1 Power interface description.....	5
2.2 Communication interface description.....	5
E96-DTU(433L20-485) can be connected to the equipment through RS-485 using terminal blocks.....	5
3. Technical Index.....	6
3.1 Model specifications.....	6
3.2 General specifications.....	7
3.3 Frequency range and channel number.....	7
3.4 Transmit power level.....	8
3.5 Air speed class.....	8
3.6 Current parameter.....	8
3.7 Sending and receiving length and sub-packing method.....	8
4. Function Details.....	9
4.1 Point-to-Point transmission (hexadecimal).....	9
4.2 Broadcast transmission (hexadecimal).....	9
4.3 Broadcast address.....	10
4.4 Listening address.....	10
5. Operating Mode.....	10
5.1 Transparent transmission mode (mode 0).....	10
5.2 WOR mode (mode 1).....	11
5.3 Power Saving mode (mode 2).....	11
5.4 Configuration mode (mode 3).....	11
6. PC Configuration Instruction.....	12
7. Program the DTU.....	12
8. Related Products.....	13
9. Precautions for Use.....	14
Important Statement.....	15
Revision History.....	15
About us.....	15

Disclaimer and Copyright Notice

The information in this article, including the URL address for reference, is subject to change without notice. The document is provided "as is" without any guarantee responsibility, including any guarantee for merchantability, suitability for a specific purpose, or non-infringement, and any guarantee mentioned elsewhere in any proposal, specification or sample. This document does not take any responsibility, including the responsibility for infringement of any patent rights caused by the use of the information in this document. This document does not grant any license for the use of intellectual property rights in estoppel or other ways, whether express or implied.

The test data obtained in the article are all obtained by the Ebyte laboratory, and the actual results may vary slightly.

All brand names, trademarks and registered trademarks mentioned in this article are the property of their respective owners, and it is hereby declared.

The final interpretation right belongs to Chengdu Ebyte Electronic Technology Co., Ltd.

Note: The content of this manual may be changed due to product version upgrades or other reasons. Ebyte Electronic Technology Co., Ltd. reserves the right to modify the contents of this manual without any notice or prompt. This manual is only used as a guide. Chengdu Ebyte Electronic Technology Co., Ltd. makes every effort to provide accurate information in this manual. However, Chengdu Ebyte Electronic Technology Co., Ltd. does not guarantee that the contents of the manual are completely free of errors. All statements in this manual, Information and suggestions do not constitute any express or implied guarantee.

1. Introduction

1.1 Brief Introduction

E96-DTU(433L20-485) is a wireless data transmission DTU that uses military-grade LoRa modulation technology. It has a variety of transmission methods. It works at (410/441M) frequency band (default 433MHz). The DTU provides a transparent RS232/RS485 interface, plastic shell, rail type installation structure, support 85~265V (AC) voltage input. LoRa spread spectrum technology will bring a longer communication distance and has the advantage of strong anti-interference ability.

As a communication medium, wireless data transmission station has a certain scope of application like optical fiber, microwave and open wire: it provides real-time and reliable data transmission of monitoring signals in private networks under certain special conditions, with low cost, installation and maintenance Convenience, strong diffraction ability, flexible network structure, and long coverage, suitable for many and scattered locations, complex geographical environment and other occasions, can be connected with PLC, RTU, rain gauge, level gauge and other data terminals.

1.2 Features

- ★ Adopt military-grade LoRa modulation technology, with data encryption, and the packet length can be set;
- ☒ Adopt flame-retardant plastic shell, guide rail type installation structure, convenient and efficient installation;
- ☒ Hidden buttons are used to switch working modes to avoid false triggers, and the equipment is more reliable in operation;
- ☒ Simple high-efficiency power supply design, support power supply configuration or line pressure mode, support 85-265V (AC) power supply;
- ☒ The transmit power can reach up to 20dBm, and supports multi-level adjustment. All technical indicators meet European industrial standards;
- ☒ Support Modbus protocol transmission;
- ★ Support wireless sending of command data packets, remote configuration or reading of DTU parameters;
- ☒ Support communication key function, effectively prevent data from being intercepted;
- ☒ Working temperature range: $-40^{\circ}\text{C} \sim +85^{\circ}\text{C}$, adapt to various harsh working environments;
- ☒ Multiple protection functions such as power pulse protection, reverse connection protection, and antenna surge protection increase the reliability of the DTU;
- ☒ The communication port and power interface adopt isolation and high protection;
- ☒ Powerful software function, all parameters can be set by programming: such as power, frequency, air rate, address ID, etc.;
- ☒ Built-in watchdog and precise time layout. Once an abnormality occurs, the DTU will automatically restart and continue to work according to the previous parameter settings.

1.3 Quick Star

- 1 Prepare two E96-DTU(433L20-485)



- 2 First install the antenna for the digital DTU, and then install the power supply. The user selects the power adapter for power supply according to the needs.



- 3 Use USB to RS485 or other methods to connect the computer to the digital DTU.



- 4 Start two serial port debugging assistants, select the serial port baud rate to be 9600bps (default), and the check method to be 8N1 to make serial port transparent transmission.

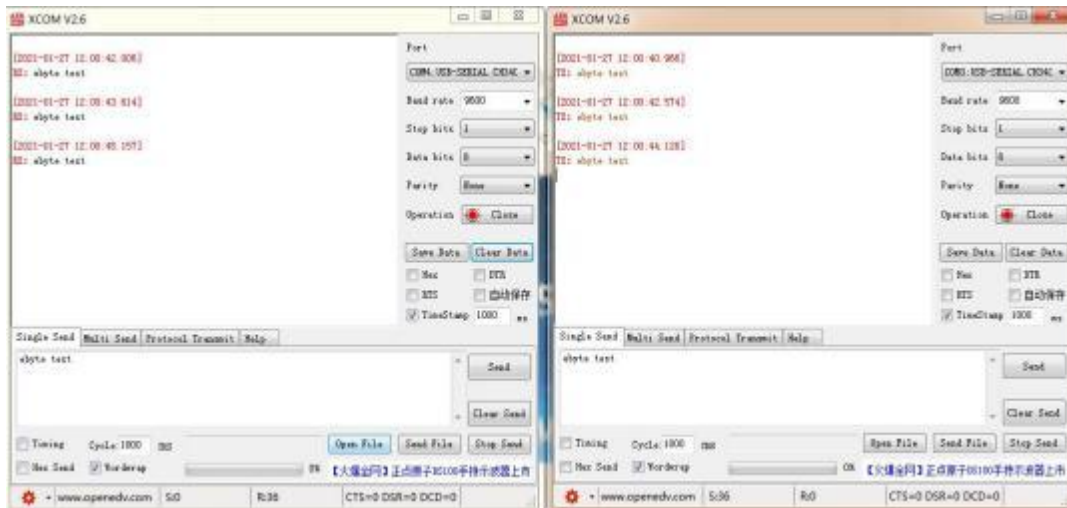

- 5 If the customer needs to switch the working mode, it can be controlled by the Mode button to switch between different working modes (M0 indicator, M1 indicator). Hold and press the Mode button for 1 second and release it to switch the mode once. The mode switching details are shown in the table below:

No.	Type	M1	M0	Description
Mode 0	Transparent Transmission Mode	Light Off	Light Off	Serial port open, wireless open, transparent transmission (factory default mode)
Mode 1	WOR Mode	Light Off	Light On	WOR transmission mode, data packet comes with wake-up code
Mode 2	Power Saving Mode	Light On	Light Off	WOR receiving mode, saving its own receiving power consumption, this mode cannot transmit

Mode 3	Configuration Mode	Light On	Light On	The DTU can be programmed using the configuration software
--------	--------------------	----------	----------	------------------------------------------------------------

⊗ **Note:** The DTU has a power-down save mode function (the factory default setting is transparent transmission mode), the user needs to switch the corresponding mode according to the M1 and M0 indicators (effective immediately).

1.4 Size

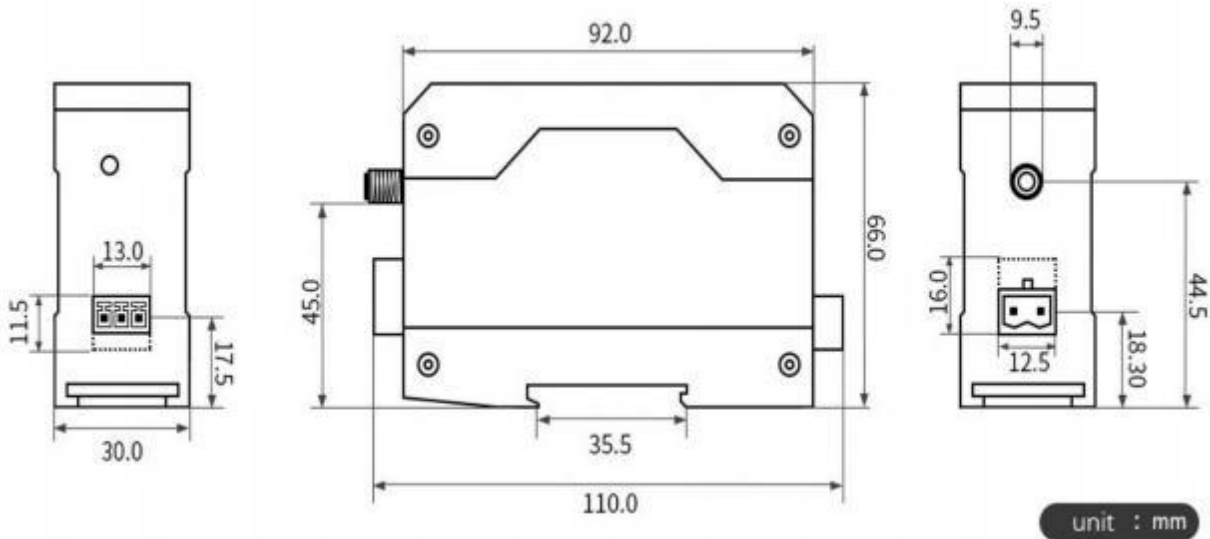

2. Interface Description

2.1 Power interface description

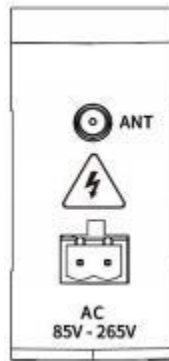

E96-DTU(433L20-485) can be powered by 85~265V (AC) power supply, The wiring port is connected by a wiring terminal (2 Pin).

2.2 Communication interface description

E96-DTU(433L20-485) can be connected to the equipment through RS-485 using terminal blocks.

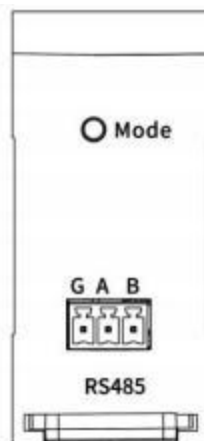

No.	Standard definition	Function	Description
1	G	Signal ground	Anti-interference, grounding
2	A	RS485 bus A interface	RS485 interface A interface is connected to device A interface
3	B	RS485 bus B interface	RS485 interface B interface is connected to device B interface

★ Note: When the radio is connected to multiple devices, the communication is not smooth, but there is no such

phenomenon in a single device. Please try to connect a 120Ω resistor in parallel between the 485_A terminal and the 485_B terminal.

3. Technical Index

3.1 Model specifications

Model	Working Frequency	Transmit Power	Distance	Specifications	Recommended Application Scenarios
	MHz	dBm	km		
E95-DTU(433L20-485)	410 ~ 441	20	3	LoRa Spread spectrum anti-interference、DC power supply	Suitable for small data volume and long-distance application.
E95-DTU(433L20-232)	410 ~ 441	20	3	LoRa Spread spectrum anti-interference、DC power supply	Suitable for small data volume and long-distance application.
E95-DTU(433L30-485)	410 ~ 441	30	8	LoRa Spread spectrum anti-interference、DC power supply	Suitable for small data volume and long-distance application.
E95-DTU(433L30-232)	410 ~ 441	30	8	LoRa Spread spectrum anti-interference、DC power supply	Suitable for small data volume and long-distance application.
E95-DTU(433L20P-485)	410 ~ 441	20	3	LoRa Spread spectrum anti-interference、DC power supply、Isolated version	Suitable for small data volume, long-distance application, high protection.
E95-DTU(433L20P-232)	410 ~ 441	20	3	LoRa Spread spectrum anti-interference、DC power supply、Isolated version	Suitable for small data volume, long-distance application, high protection.
E95-DTU(433L30P-485)	410 ~ 441	30	8	LoRa Spread spectrum anti-interference、DC power supply、Isolated version	Suitable for small data volume, long-distance application, high protection.
E95-DTU(433L30P-232)	410 ~ 441	30	8	LoRa Spread spectrum anti-interference、DC power supply、Isolated version	Suitable for small data volume, long-distance application, high protection.

E96-DTU(433L20-485)	410 ~ 441	20	3	LoRa Spread spectrum anti-interference、AC power supply、	Suitable for small data volume, long-distance application
E96-DTU(433L20-232)	410 ~ 441	20	3	LoRa Spread spectrum anti-interference、AC power supply、	Suitable for small data volume, long-distance application
E96-DTU(433L30-485)	410 ~ 441	30	8	LoRa Spread spectrum anti-interference、AC power supply、	Suitable for small data volume, long-distance application
E96-DTU(433L30-232)	410 ~ 441	30	8	LoRa Spread spectrum anti-interference、AC power supply、	Suitable for small data volume, long-distance application

★ Note: In fine weather, open environment without obstruction, 12V/1A power supply, 5dBi suction cup antenna, the antenna is 2 meters above the ground, and the factory default parameters are used.

3.2 General specifications

No.	Terms	Specifications	Description
1	Size	92*67*30 mm	Review installation dimensions for details
2	Weight	95 g	Weight tolerance 5g
3	Working Temperature	-40℃~+85℃	Meet the needs of industrial use
4	Voltage Range	85~265V (AC)	It is recommended to use 12V or 24V for DC version AC version can use 110V/220V
5	Interface	RS485	RS485
6	Baud Rate	Default 9600	Baud rate range 1200~115200
7	Address Code	Default 0	A total of 65536 address codes can be set

3.3 Frequency range and channel number

Model	Default Frequency	Frequency Range	Channel Spacing	Number of Channels
	Hz	Hz	Hz	
E96-DTU(433L20-485)	433M	410~441M	1M	32 , Half Duplex

- ★ Note: In the same area, multiple groups of digital DTUs are used for one-to-one communication at the same time. It is recommended that each group of digital DTUs set the channel spacing above 2MHz.

3.4 Transmit power level

Model	20dBm	17dBm / 27dBm	13dBm / 24dBm	10dBm / 21dBm
E96-DTU(433L20-485)	Factory Default	√	√	√

- ★ Note: The lower the transmission power, the closer the transmission distance, but the working current will not decrease in the same proportion. It is recommended to use the maximum transmission power.

3.5 Air speed class

Model	Default Air Rate	Level	Air Speed Class
	bps		bps
E96-DTU(433L20-485)	2.4k	6	0.3k、1.2k、2.4k、4.8k、9.6k、19.2k

- ★ The higher the air speed setting, the faster the transmission rate and the shorter the transmission distance; therefore, when the speed meets the requirements of use, it is recommended that the airspeed be as low as possible.

3.6 Current parameter

Model	Transmitting Current mA		Waiting Current mA	
	12V	24V	12V	24V
E96-DTU(433L20-485)	230	135	20	12

- ★ Note: It is recommended to reserve more than 50% of the current margin when selecting the power supply, which is conducive to the long-term stable operation of the DTU.

3.7 Sending and receiving length and sub-packing method

Model	Cache Size	Sub-packing Method
E96-DTU(433L20-485)-V8	512 bytes	Auto sub-packing 58 bytes

- ★ Note:
 1. If the DTU's single received data is greater than the single packet capacity, the excess data will be automatically allocated to the second transmission until the transmission is completed;
 2. The single received data of the DTU cannot be larger than the buffer capacity.

4. Function Details

4.1 Point-to-Point transmission (hexadecimal)

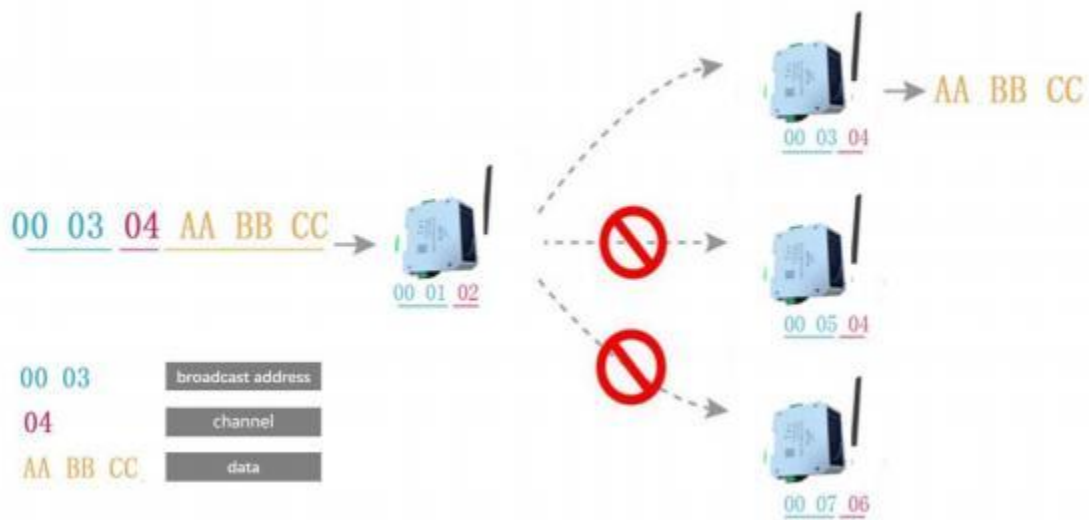

4.2 Broadcast transmission (hexadecimal)

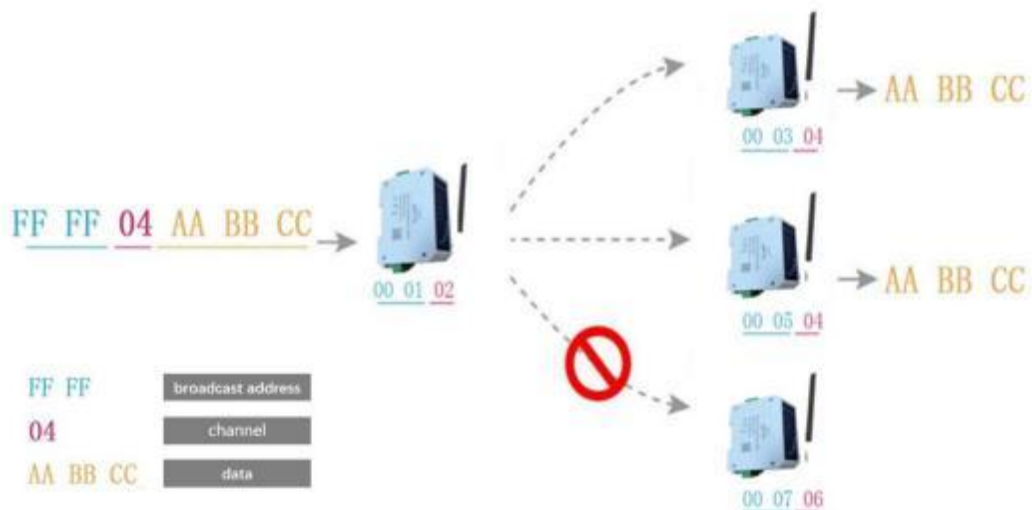

4.3 Broadcast address

- ☞ Example: Set the address of DTUA to 0xFFFF and the channel to 0x04.
- ☞ When DTU A is used as a transmitter (same mode, transparent transmission mode), all receiving DTU under the 0x04 channel can receive data to achieve the purpose of broadcasting.

4.4 Listening address

- ☞ Example: Set the address of DTUA to 0xFFFF and the channel to 0x04.
- ☞ When DTUA is receiving, it can receive all the data under channel 0x04 to achieve the purpose of monitoring.

5. Operating Mode

E95-DTU has four working modes. When there is no demanding low power consumption requirement, it is recommended to configure the DTU to transparent transmission mode (mode 0) if normal communication is required;

The default setting of the DTU at the factory is transparent transmission mode (mode 0).

No.	Type	M1	M0	Description
Mode 0	Transparent transmission mode	Light Off	Light Off	Serial port open, wireless open, transparent transmission (factory default mode)
Mode 1	WOR Mode	Light Off	Light On	WOR transmission mode, data packet comes with wake-up code
Mode 2	Power Saving Mode	Light On	Light Off	WOR receiving mode, saving its own receiving power consumption, this mode cannot transmit
Mode 3	Configuration Mode	Light On	Light On	The DTU can be programmed using the configuration software

5.1 Transparent transmission mode (mode 0)

Type	When the M0 indicator light is off and the M1 indicator light is off, the DTU is working in mode 0
Sending	Users can input data through the serial port, and the DTU will start wireless transmission.
Receiving	The DTU receiving function is turned on, and after receiving the wireless data, it will be output through the serial port TXD pin.

5.2 WOR mode (mode 1)

Type	When the M0 indicator light is on and the M1 indicator light is off, the DTU is working in mode 1
Description	WOR transmission mode, data packet comes with wake-up code

5.3 Power Saving mode (mode 2)

Type	When the M0 indicator light is off and the M1 indicator light is on, the DTU is working in mode 2
Description	WOR receiving mode, saving its own receiving power consumption, this mode cannot transmit

5.4 Configuration mode (mode 3)

Type	When the M0 indicator light is on and the M1 indicator light is on, the DTU is working in mode 3
Description	The DTU can be programmed using the configuration software

6. PC Configuration Instruction

The following figure shows the display interface of the E96-DTU(433L20-485) configuration host computer. The user can switch to the configuration mode through the MODE button, and quickly configure and read the parameters on the host computer.



7. Program the DTU

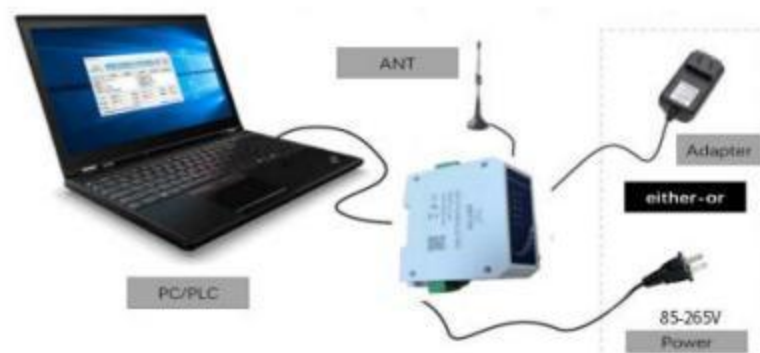

Operating Mode	M1	M0	Remark
Configuration mode	Light On	Light Off	Only use the configuration software to program the DTU in the current mode

1. Programming can only be carried out in a specific working mode (see the above table). If the programming fails, please confirm whether the working mode of the DTU is correct.
2. If you don't need complicated programming to open the E96-DTU(433L20-485) configuration software, you can modify the relevant parameters.

8. Related Products

Model	Interface Type	Frequency Hz	Transmit power dBm	Distance km	Features
E95-DTU(433L20-485)	RS485	410 ~ 441	20	3	Cost-effective LoRa, rail type, RS485, E90-DTU L series intercommunication, DC power supply
E95-DTU(433L20-232)	RS232	410 ~ 441	20	3	Cost-effective LoRa, rail type, RS232, E90-DTU L series intercommunication, DC power supply
E95-DTU(433L30-485)	RS485	410 ~ 441	30	8	Cost-effective LoRa, rail type, RS485, E90-DTU L series intercommunication, DC power supply
E95-DTU(433L30-232)	RS232	410 ~ 441	30	8	Cost-effective LoRa, rail type, RS232, E90-DTU L series intercommunication, DC power supply
E95-DTU(433L20P-485)	RS485	410 ~ 441	20	3	Cost-effective LoRa, rail type, RS485, E90-DTU L series intercommunication, high protection, DC power supply
E95-DTU(433L20P-232)	RS232	410 ~ 441	20	3	Cost-effective LoRa, rail type, RS232, E90-DTU L series intercommunication, high protection, DC power supply
E95-DTU(433L30P-485)	RS485	410 ~ 441	30	8	Cost-effective LoRa, rail type, RS485, E90-DTU L series intercommunication, high protection, DC power supply
E95-DTU(433L30P-232)	RS232	410 ~ 441	30	8	Cost-effective LoRa, rail type, RS232, E90-DTU L series intercommunication, high protection, DC power supply
E96-DTU(433L20-485)	RS485	410 ~ 441	20	3	Cost-effective LoRa, rail type, RS485, E90-DTU L series intercommunication, AC

					power supply
E96-DTU(433L20-232)	RS232	410 ~ 441	20	3	Cost-effective LoRa, rail type, RS232, E90-DTU L series intercommunication, AC power supply
E96-DTU(433L30-485)	RS485	410 ~ 441	30	8	Cost-effective LoRa, rail type, RS485, E90-DTU L series intercommunication, AC power supply
E96-DTU(433L30-232)	RS232	410 ~ 441	30	8	Cost-effective LoRa, rail type, RS232, E90-DTU L series intercommunication, AC power supply

9. Precautions for Use

1. Please take good care of the warranty card of the device. The warranty card contains the factory number (and important technical parameters) of the device, which has important reference value for the user's future maintenance and new equipment.
2. During the warranty period, if the DTU is damaged due to the quality of the product itself rather than man-made damage or natural disasters such as lightning strikes, it enjoys free warranty; please do not repair by yourself, and contact our company if there is a problem. Ebyte provides first-class After-sales service.
3. Do not operate this DTU in the vicinity of some flammable places (such as coal mines) or explosive dangerous objects (such as detonators for detonation).
4. A suitable DC stabilized power supply should be selected, which requires strong anti-high frequency interference, small ripple, and sufficient load capacity; preferably, it should also have over-current, over-voltage protection and lightning protection functions to ensure that the DTU is normal jobs.
5. Do not use it in a working environment that exceeds the environmental characteristics of the DTU, such as high temperature, humidity, low temperature, strong electromagnetic field or dusty environment.
6. Don't let the DTU continuously be in full load transmitting state, otherwise the transmitter may be burnt out.
7. The ground wire of the DTU should be well connected with the ground wire of the external equipment (such as PC, PLC, etc.) and the ground wire of the power supply, otherwise the communication interface will be burnt easily; do not plug or unplug the serial port with power on.
8. When testing a DTU, you must connect a matching antenna or a 50Ω dummy load, otherwise the transmitter will be easily damaged; if the antenna is connected, the distance between the human body and the antenna should be more than 2 meters to avoid injury. Touch the antenna when transmitting.
9. Wireless data transmission stations often have different communication distances in different environments. The communication distance is often affected by temperature, humidity, obstacle density, obstacle volume, and electromagnetic environment; in order to ensure stable communication, it is recommended to reserve more than 50% The communication distance margin.
10. If the measured communication distance is not ideal, it is recommended to analyze and improve the communication distance from the antenna quality and antenna installation method. You can also contact support@cdebyte.com for help.
11. When selecting the power supply, in addition to keeping 50% of the current margin as recommended, it should also be noted that its ripple must not exceed 100mV.
12. Wireless communication products need to be connected to an impedance-matched antenna to work normally. Even short-term tests cannot be omitted. Product damage caused by this reason will not be covered by the warranty.

Important Statement

1. Ebyte reserves the right of final interpretation and modification of all contents in this manual.
2. Due to the continuous improvement of product hardware and software, this manual may be changed without prior notice. The latest version of the manual shall prevail.
3. It is everyone's responsibility to protect the environment: In order to reduce the use of paper, this manual only prints the Chinese part, and the English manual only provides electronic documents. If necessary, please download it from our official website; in addition, if not specifically requested by the user, the user can order in bulk. At the time, we only provide product manuals according to a certain percentage of the order quantity, not every DTU is matched with it, please understand.

Revision History

Version	Date	Description	Issued By
1.0	2020-08-17	Original Version	ken
1.1	2021-02-05	L series integration	ken
1.2	2023-7-18	Bug repair	Hao

About us

Technical support: support@cdebyte.com

Documents and RF Setting download link: : <https://www.cdebyte.com>

Thank you for using Ebyte products! Please contact us with any questions or suggestions: info@cdebyte.com

Official hotline:028-61399028

Web: <https://www.cdebyte.com>

Address: B5 Mould Park, 199# Xiqu Ave, High-tech District, Sichuan, China



Chengdu Ebyte Electronic Technology Co.,Ltd.