



Chengdu Ebyte Electronic Technology Co.,Ltd

# Wireless Modem

## User Manual



**E95-DTU (400SL22-485)**

All rights to interpret and modify this manual belong to  
Chengdu Ebyte Electronic Technology Co., Ltd.

## Contents

1. Introduction .....	3
1.1 Brief Introduction .....	3
1.2 Features .....	3
1.3 Quick Start .....	4
1.4 Parts Description .....	6
1.5 Size .....	7
2. Interface Description .....	7
2.1 Power interface description .....	7
2.2 Communication interface description .....	8
3. Technical Index .....	9
3.1 Model specification .....	9
3.2 General specifications .....	9
3.3 Frequency range and channel number .....	9
3.4 Transmit power level .....	10
3.5 Air speed class .....	10
3.6 Current parameter .....	10
3.7 Sending and receiving length and data separate method .....	10
4. Function Details .....	11
4.1 Fixed-point transmission (hexadecimal) .....	11
4.2 Broadcast transmission (hexadecimal) .....	11
4.3 Broadcast address .....	12
4.4 Listening address .....	12
5. Operating mode .....	12
5.1 Transparent transmission mode (mode 0) .....	12
5.2 WOR mode (mode 1) .....	13
5.3 Configuration mode (mode 2) .....	13
5.4 Deep sleep mode (mode 3) .....	13
6. Register read and write control .....	13
6.1 Instruction format .....	13
6.2 Register description .....	14
6.3 Factory default parameters .....	17
7. Relay Network Mode Use .....	17
8. PC Configuration Instructions .....	18
9. Program the DTU .....	19
10. Connection Diagram in Test and Practical Application .....	20
11. Related Products .....	20
12. Practical Application .....	21
13. Precautions for Use .....	22
Important Statement .....	23
Revision History .....	23
About us .....	23

# 1. Introduction

## 1.1 Brief Introduction

E95-DTU (400SL22-485) is a wireless data transmission DTU that uses military-grade LoRa modulation technology. It has a variety of transmission methods. It works in the (410.125MHz ~ 493.125MHz) frequency band (default 433.125MHz). The DTU provides a transparent RS485 interface, plastic shell, rail type installation structure, support 8-28V voltage input. LoRa spread spectrum technology will bring a longer communication distance, and has the advantage of strong anti-interference ability.

As a communication medium, wireless data transmission station has a certain scope of application like optical fiber, microwave and open wire: it provides real-time and reliable data transmission of monitoring signals in private networks under certain special conditions, with low cost, installation and maintenance convenience, strong diffraction ability, flexible network structure, and long coverage. It is suitable for many and scattered locations and complex geographic environments. It can be connected with PLC, RTU, rain gauge, level gauge and other data terminals.

## 1.2 Features

- ★ Using the latest LoRa technology, it is farther and more powerful than traditional LoRa digital DTU;
- ★ Adopt military-grade LoRa modulation technology, with data encryption, and the packet length can be set;
- ★ Adopt flame-retardant plastic shell, guide rail type installation structure, convenient and efficient installation
- ★ Hidden buttons are used to switch working modes to avoid false triggers, and the equipment is more reliable in operation;
- ★ Simple high-efficiency power supply design, support power supply configuration or line pressure mode, support 8 ~ 28V power supply;
- ★ The transmit power can reach up to 22dBm, and supports multi-level adjustment, and all technical indicators meet European industrial standards;
- ★ Support LBT function, the DTU automatically waits for transmission according to the current environmental noise intensity. Greatly improve the communication success rate of the DTU in harsh environments;
- ★ Support wireless sending of command data packets, remote configuration or reading of DTU parameters;
- ★ Support communication key function, effectively prevent data from being intercepted;
- ★ It can realize multi-level relay networking, effectively expand the communication distance, and realize ultra-long-distance communication;
- ★ Using temperature compensation circuit, the frequency stability is better than  $\pm 1.5\text{PPM}$ ;
- ★ Working temperature range:  $-40^{\circ}\text{C} \sim +85^{\circ}\text{C}$ , adapt to various harsh working environments, real industrial grade products;
- ★ All aluminum alloy shell, compact size, convenient installation, good heat dissipation; perfect shielding design, good electromagnetic compatibility, strong anti-interference ability;
- ★ Multiple protection functions such as power reverse connection protection, over-connection protection, antenna surge protection, etc., greatly increase the reliability of the DTU;
- ★ Powerful software function, all parameters can be set by programming: such as power, frequency, air rate, address ID, etc.;
- ★ Ultra-low power consumption, standby current is only 15mA (lower power consumption in power-saving mode and sleep mode);
- ★ Built-in watchdog and precise time layout. Once an abnormality occurs, the DTU will automatically restart and continue to work according to the previous parameter settings.

## 1.3 Quick Start

- ① Prepare two E95-DTU (400SL22-485)



- ② First install the antenna for the digital DTU, and then install the power supply. The user selects the power adapter for power supply according to the needs.



- ③ Use USB to RS-485 or other methods to connect the computer to the digital DTU;



- ④ Start two serial port debugging assistants, select the serial port baud rate to be 9600bps (default), and the check method to be 8N1 to make serial port transparent transmission;

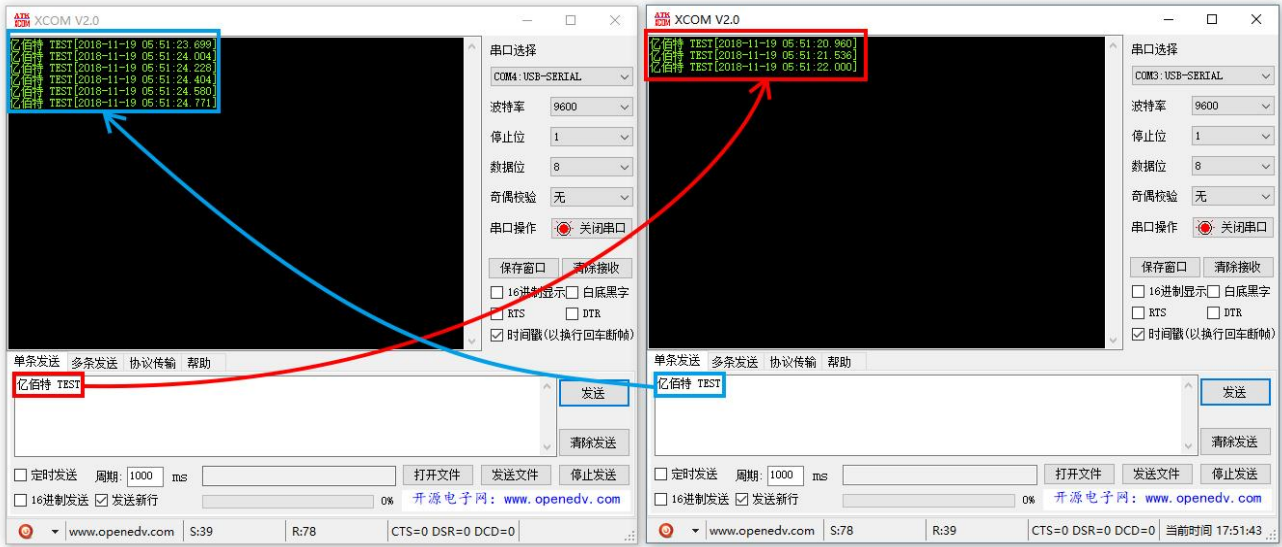

- ⑤ If the customer needs to switch the working mode, it can be controlled by the Mode button to switch between different working modes (M0 indicator, M1 indicator). Press and hold the Mode button for about 1ms and then release it to switch modes. The mode switching details are shown in the table below:

No.	Type	M1	M0	Description
Mode 0	Transparent Transmission Mode	Light Off	Light Off	Serial port open, wireless open, transparent transmission (factory default mode), support special command air configuration
Mode 1	WOR Mode	Light Off	Light On	Can be defined as WOR sender and WOR receiver, support air wakeup
Mode 2	Configuration Mode	Light On	Light Off	The user accesses the register through the serial port to control the working status of the DTU. The user can configure the DTU through the computer configuration software.
Mode 3	Deep Sleep Mode	Light On	Light On	DTU goes to sleep mode

★ Note: The DTU has a power-down save mode function (the factory default setting is transparent transmission mode), the user needs to switch the corresponding mode according to the M1 and M0 indicators (effective immediately).

## 1.4 Parts Description

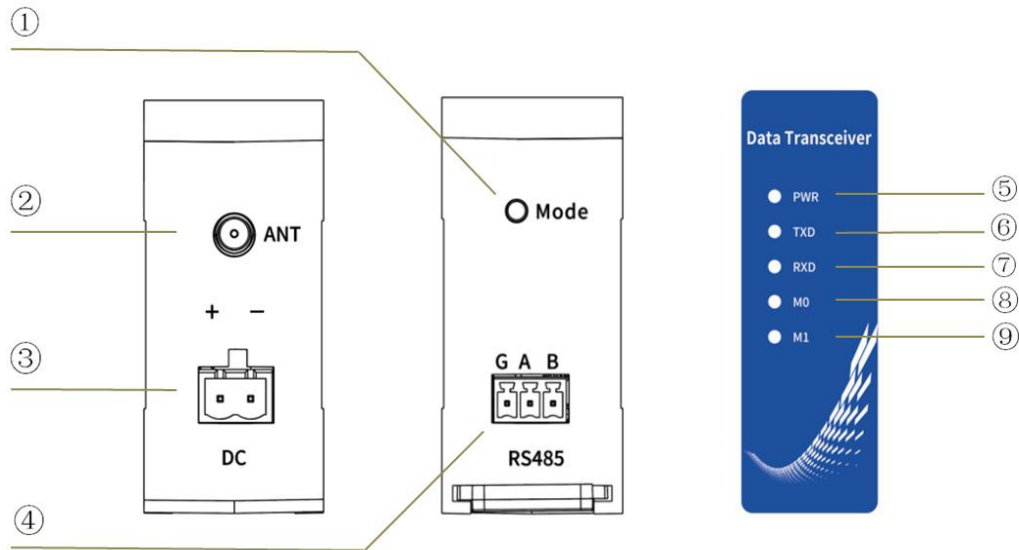

No.	Name	Function	Description
1	Mode	Mode switch button	Working mode switching control
2	ANT	RF interface	SMA-K, External thread inner hole
3	DC	Power supply	DC power input port, pressure line port
4	RS485	RS485 interface	Standard RS-485 interface
5	PWR	Power indicator	Lights up when the power is on
6	TXD	Sending indicator	Flashes when sending data
7	RXD	Receiving indicator	Flashes when receiving data
8	MO	Mode indicator	Working mode indicator
9	M1	Mode indicator	Working mode indicator

## 1.5 Size

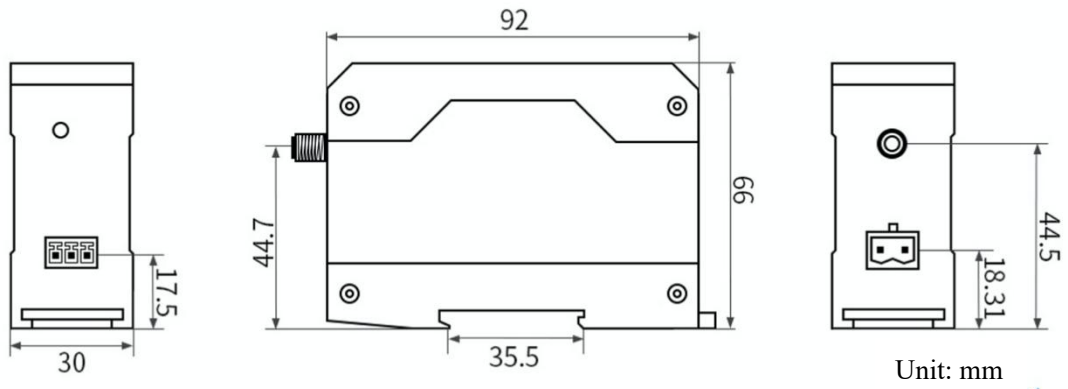

## 2. Interface Description

### 2.1 Power interface description

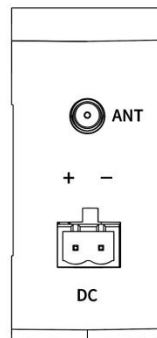

E95-DTU can be powered by 8~28V DC power supply, it is recommended to use 12V or 24V DC power supply. The wiring port adopts 3.81 wiring terminal (2 Pin) connection.

## 2.2 Communication interface description

E95-DTU can use 3.81 terminal block to connect with equipment through RS-485.

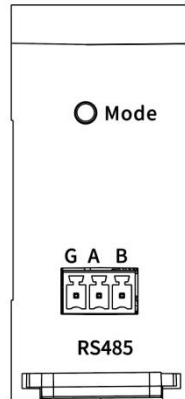

No.	Standard definition	Function	Description
1	G	Pressure line interface, signal ground	Anti-interference, grounding
2	A	RS-485 bus A interface	RS-485 A interface is connected to device A interface
3	B	RS-485 bus B interface	RS-485 B interface is connected to device B interface

- ★ Note: The communication is not smooth when connecting the DTU to multiple devices, but there is no such phenomenon in a single device. Please try to connect a 120Ω resistor in parallel between the 485\_A terminal and the 485\_B terminal.



## 3. Technical Index

### 3.1 Model specification

Model	Working Frequency	Transmit Power	Distance	Specifications	Recommended Application Scenarios
	Hz	dBm	km		
E95-DTU(400SL22-485)	410.125MHz ~493.125MHz	22	5	LoRa Spread spectrum anti-interference	Suitable for environments with long distances and susceptible to interference

★ Note: Sunny, open environment without obstruction, 12V/1A power supply, 5dBi suction antenna, antenna height 2 meters from the ground, use factory default parameters.

### 3.2 General specifications

No.	Term	Specification	Description
1	Size	92*67*30 mm	Review installation dimensions for details
2	Weight	95 g	Weight tolerance 5g
3	Working Temperature	-40°C~+85°C	Meet the needs of industrial use
4	Voltage Range	8~28V DC	Recommend to use 12V or 24V
5	Interface	RS485	3.81 terminal block
6	Baud Rate	Default 9600	Baud rate range 1200~115200
7	Address Code	Default 0	A total of 65536 address codes can be set

### 3.3 Frequency range and channel number

Model	Default Frequency	Frequency Range	Channel Spacing	Number of Channels
	Hz	Hz	Hz	
E95-DTU(400SL22-485)	433.125M	410.125~493.125M	1M	84, Half Duplex

★ Note: In the same area, multiple groups of digital DTUs are used for one-to-one communication at the same time. It is recommended that each group of digital DTUs set the channel spacing above 2MHz.

### 3.4 Transmit power level

Model	22dBm	17dBm	13dBm	10dBm
E95-DTU(400SL22-485)	Factory Default	√	√	√

- ★ Note: The lower the transmission power, the closer the transmission distance, but the working current will not decrease in the same proportion. It is recommended to use the maximum transmission power.

### 3.5 Air speed class

Model	Default Air Rate	Level	Air Speed Class
	bps		bps
E95-DTU(400SL22-485)	2.4k	8	0.3、1.2、2.4、4.8、9.6、19.2、38.4、62.5k

- ★ Note: The higher the air speed setting, the faster the transmission rate and the shorter the transmission distance; therefore, when the speed meets the requirements of use, it is recommended that the airspeed be as low as possible.

### 3.6 Current parameter

Model	Transmitting Current mA		Waiting Current mA	
	12V	24V	12V	24V
E95-DTU(400SL22-485)	45	26	10	7

- ★ Note: It is recommended to reserve more than 50% of the current margin when selecting the power supply, which is conducive to the long-term stable operation of the DTU.

### 3.7 Sending and receiving length and data separate method

Model	Cache Size	Data Separate Method
E95-DTU(400SL22-485)	1000 Bytes	Data can be separated sent with 32/64/128/240 bytes by command

- ★ Note:

1. If the DTU's single received data is greater than the single packet capacity, the excess data will be automatically allocated to the second transmission until the transmission is completed;
2. The single received data of the DTU cannot be larger than the buffer capacity.

## 4. Function Details

### 4.1 Fixed-point transmission (hexadecimal)

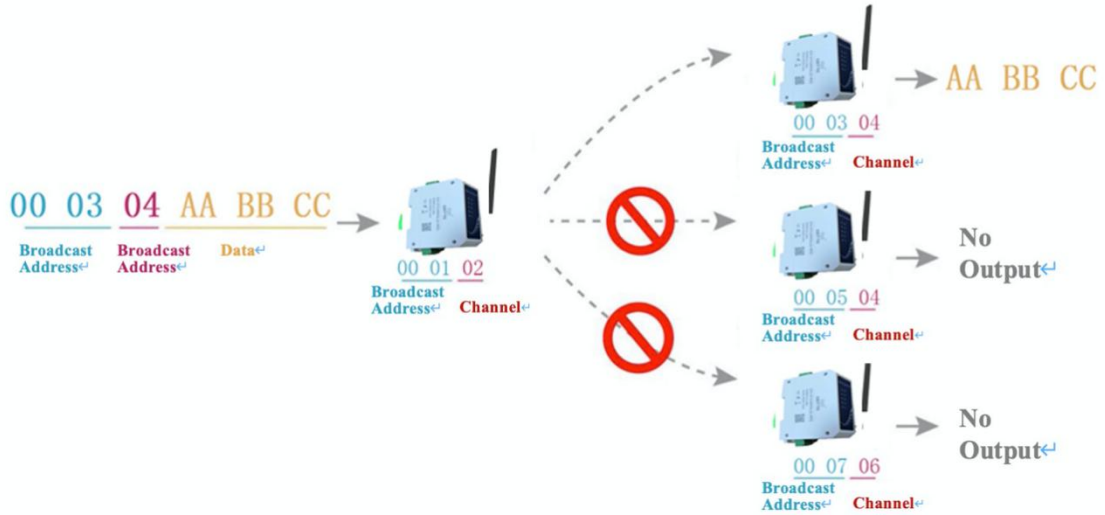

### 4.2 Broadcast transmission (hexadecimal)

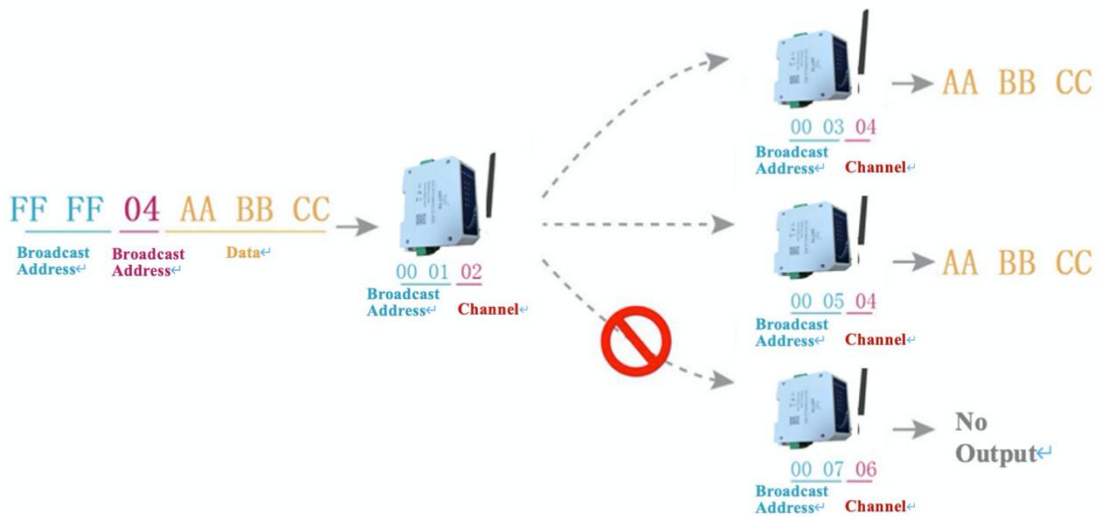

## 4.3 Broadcast address

- Example: Set the address of DTU A to 0xFFFF and the channel to 0x04.
- When DTU A is used as a transmitter (same mode, transparent transmission mode), all receiving DTU under the 0x04 channel can receive data to achieve the purpose of broadcasting.

## 4.4 Listening address

- Example: Set the address of DTU A to 0xFFFF and the channel to 0x04.
- When DTU A is receiving, it can receive all the data under channel 0x04 to achieve the purpose of monitoring.

## 5. Operating mode

E95-DTU has four working modes. When there is no demanding low power consumption requirement, it is recommended to configure the DTU to transparent transmission mode (mode 0) if normal communication is required;

The default setting of the DTU at the factory is transparent transmission mode (mode 0).

No.	Type	M1	M0	Description
Mode 0	Transparent transmission mode	Light Off	Light Off	Serial port open, wireless open, transparent transmission (factory default mode), support special command air configuration.
Mode 1	WOR Mode	Light Off	Light On	Can be defined as WOR sender and WOR receiver, support air wakeup
Mode 2	Configuration Mode	Light On	Light Off	The user accesses the register through the serial port to control the working status of the DTU. The user can configure the DTU through the upper computer configuration software.
Mode 3	Deep Sleep Mode	Light On	Light On	DTU goes to sleep mode.

Note: If there is no low power consumption requirement, no need to care about WOR mode (mode 1).

### 5.1 Transparent transmission mode (mode 0)

Type	When the M0 indicator light is off and the M1 indicator light is off, the DTU is working in mode 0
Sending	Users can input data through the serial port, and the DTU will start wireless transmission.
Receiving	The DTU receiving function is turned on, and after receiving the wireless data, it will be output through the serial port TXD pin.

## 5.2 WOR mode (mode 1)

Type	When the M0 indicator light is on and the M1 indicator light is off, the DTU is working in mode 1
Sending	When defined as the transmitter, the wake-up code for a certain period of time will be automatically added before transmission
Receiving	Data can be received normally, and the receiving function is equivalent to mode 0

## 5.3 Configuration mode (mode 2)

Type	When the M0 indicator light is off and the M1 indicator light is on, the DTU is working in mode 2
Sending	Can be configured wirelessly
Receiving	Can be configured wirelessly
Configuring	The user can access the register to configure the working status of the radio

## 5.4 Deep sleep mode (mode 3)

Type	When the M0 indicator light is on and the M1 indicator light is on, the DTU is working in mode 3
Sending	Unable to transmit data wirelessly.
Receiving	Unable to receive data wirelessly.

# 6. Register read and write control

## 6.1 Instruction format

In configuration mode (mode 2: M1 indicator light is on, M0 indicator light is off), the supported command list is as follows (when setting, only 9600, 8N1 format is supported):

No.	Instruction Format	Detailed Description															
1	Set Register	Command: C0+start address+length+parameter C1+start address+length+parameter  Example 1: Configure the channel as 0x09 <table border="1"> <thead> <tr> <th>Instruction</th> <th>Start Address</th> <th>Length</th> <th>Parameter</th> </tr> </thead> <tbody> <tr> <td>Send: C0</td> <td>05</td> <td>01</td> <td>09</td> </tr> <tr> <td>Return: C1</td> <td>05</td> <td>01</td> <td>09</td> </tr> </tbody> </table> Example 2: Configure the radio address (0x1234), network address (0x00), serial port (9600 8N1), airspeed (1.2K) at the same time Send: C0 00 04 12 34 00 61 Return: C1 00 04 12 34 00 61	Instruction	Start Address	Length	Parameter	Send: C0	05	01	09	Return: C1	05	01	09			
Instruction	Start Address	Length	Parameter														
Send: C0	05	01	09														
Return: C1	05	01	09														
2	Read Register	Command: C1+start address+length Response: C1+start address+length+parameter  Example 1: Read the channel <table border="1"> <thead> <tr> <th>Instruction</th> <th>Start Address</th> <th>Length</th> <th>Parameter</th> </tr> </thead> <tbody> <tr> <td>Send: C1</td> <td>05</td> <td>01</td> <td></td> </tr> <tr> <td>Return: C1</td> <td>05</td> <td>01</td> <td>09</td> </tr> </tbody> </table> Example 2: Read the DTU address, network address, serial port, airspeed at the same time Send: C1 00 04 Return: C1 00 04 12 34 00 61	Instruction	Start Address	Length	Parameter	Send: C1	05	01		Return: C1	05	01	09			
Instruction	Start Address	Length	Parameter														
Send: C1	05	01															
Return: C1	05	01	09														
3	Set Up Temporary Register	Command: C2 + start address + length + parameters Response: C1 + start address + length + parameters  Example 1: Configure the channel as 0x09 <table border="1"> <thead> <tr> <th>Instruction</th> <th>Start Address</th> <th>Length</th> <th>Parameter</th> </tr> </thead> <tbody> <tr> <td>Send: C2</td> <td>05</td> <td>01</td> <td>09</td> </tr> <tr> <td>Return: C1</td> <td>05</td> <td>01</td> <td>09</td> </tr> </tbody> </table> Example 2: Configure the DTU address (0x1234), network address (0x00), serial port (9600 8N1), airspeed (1.2K) at the same time Send: C2 00 04 12 34 00 61 Return: C1 00 04 12 34 00 61	Instruction	Start Address	Length	Parameter	Send: C2	05	01	09	Return: C1	05	01	09			
Instruction	Start Address	Length	Parameter														
Send: C2	05	01	09														
Return: C1	05	01	09														
4	Wireless Configuration	Instructions: CF CF + regular instructions Response: CF CF + regular response  Example 1: The wireless configuration channel is 0x09 <table border="1"> <thead> <tr> <th>Wireless Command Header</th> <th>Command</th> <th>Start Address</th> <th>Length</th> <th>Parameter</th> </tr> </thead> <tbody> <tr> <td>Send: CF CF</td> <td>C0</td> <td>05</td> <td>01</td> <td>09</td> </tr> <tr> <td>Return: CF CF</td> <td>C1</td> <td>05</td> <td>01</td> <td>09</td> </tr> </tbody> </table> Example 2: Wirelessly configure the DTU address (0x1234), network address (0x00), serial port (9600 8N1), airspeed (1.2K) at the same time Send: CF CF C0 00 04 12 34 00 61 Return: CF CF C1 00 04 12 34 00 61	Wireless Command Header	Command	Start Address	Length	Parameter	Send: CF CF	C0	05	01	09	Return: CF CF	C1	05	01	09
Wireless Command Header	Command	Start Address	Length	Parameter													
Send: CF CF	C0	05	01	09													
Return: CF CF	C1	05	01	09													
5	Format Error	Format Error Response FF FF FF															

## 6.2 Register description

No.	Read and Write	Name	Description	Remarks
00H	Read/Write	ADDH	ADDH (Default 0)	High byte and low byte of radio address; Note: When the DTU address is equal to FFFF, it can be used as the broadcast and monitor address, that is: the DTU will not perform address filtering at this time
01H	Read/Write	ADDL	ADDL (Default 0)	

02H	Read/Write	NETID	NETID (Default 0)			Network address, used to distinguish networks; When communicating with each other, they should be set to the same.	
03H	Read/Write	REG0	7	6	5	UART serial port rate (bps)	For two DTUs that communicate with each other, the serial port baud rate can be different, and the verification method can also be different;  When continuously transmitting large data packets, users need to consider the data congestion caused by the same baud rate, and may even be lost;  It is generally recommended that the baud rate of the two communication parties be the same.
			0	0	0	The serial port baud rate is 1200	
			0	0	1	The serial port baud rate is 2400	
			0	1	0	The serial port baud rate is 4800	
			0	1	1	The serial port baud rate is 9600 (default)	
			1	0	0	The serial port baud rate is 19200	
			1	0	1	The serial port baud rate is 38400	
			1	1	0	The serial port baud rate is 57600	
			1	1	1	The serial port baud rate is 115200	
		4	3	Serial parity bit		The serial port mode of the two communication parties can be different;	
		0	0	8N1 (default)			
		0	1	8O1			
		1	0	8E1			
		1	1	8N1 (等同 00)			
		2	1	0	Wireless air rate (bps)		The air rate of both parties must be the same;  The higher the air rate, the smaller the delay and the shorter the transmission distance.
		0	0	0	Air speed 0.3k		
		0	0	1	Air speed 1.2k		
		0	1	0	Air speed 2.4k (default)		
		0	1	1	Air speed 4.8k		
1	0	0	Air speed 9.6k				
1	0	1	Air speed 19.2k				
1	1	0	Air speed 38.4k				
1	1	1	Air speed 62.5k				
04H	Read/Write	REG1	7	6	Data Packet Separate setting		The data sent by the user is less than the data packet separate length, and the serial port output of the receiving end appears as an uninterrupted continuous output;  If the data sent by the user is larger than the data packet separate length, the serial port of the receiving end will be output in packets.
			0	0	240 Bytes (default)		
			0	1	128 Bytes		
			1	0	64 Bytes		
			1	1	32 Bytes		
		5	RSSI Environmental noise enable			After enabling, you can send commands C0 C1 C2 C3 in transmission mode or WOR sending mode to read registers; Register 0x00: Current environmental noise RSSI; Register 0X01: RSSI when receiving data last time (The current channel noise is: dBm =-RSSI/2); Instruction format: C0 C1 C2 C3 + start address + read length; Return: C1 + address address + read length + read effective value; for example: send C0 C1 C2 C3 00 01 Return C1 00 01 RSSI	
		0	Disabled (default)				
		1	Enable				
			4	3	2	Remain	

			1	0	Transmit power	
			0	0	22dBm (default)	
			0	1	17dBm	
			1	0	13dBm	
			1	1	10dBm	
			The relationship between power and current is non-linear, and the power supply has the highest efficiency at maximum power;			
			The current will not decrease in the same proportion as the power decreases.			
05H	Read/Write	REG2	Channel Control (CH) 0-83 respectively represent a total of 84 channels		Actual frequency = 410.125 + CH *1M	
06H	Read/Write	REG3	7	Enable RSSI byte		After being enabled, the DTU receives wireless data and outputs it through the serial port TXD, followed by an RSSI strength byte.
			0	Disabled (default)		
			1	Enable		
			6	Transfer method		During fixed-point transmission, the DTU will recognize the three bytes of serial data as: address high + address low + channel, and use it as a wireless transmission target.
			0	Transparent transmission (default)		
			1	Fixed point transmission		
			5	Relay function		After the relay function is enabled, if the target address is not the DTU itself, the DTU will start a forwarding; In order to prevent data from returning, it is recommended to use it in conjunction with the fixed-point mode; that is, the destination address is different from the source address.
			0	Disable relay function (default)		
			1	Enable relay function		
			4	LBT Enable		After enabling, monitoring will be conducted before wireless data transmission, which can avoid interference to a certain extent, but may cause data delay;  The maximum stay time of LBT is 2 seconds, and it will be issued forcibly when it reaches 2 seconds.
			0	Disabled (default)		
			1	Enable		
			3	WOR Mode send and receive control		Only valid for mode 1;  After the WOR receiver receives the wireless data and outputs it through the serial port, it will wait 1000ms before entering the WOR again. The user can input the serial port data during this period and return it via wireless;
			0	WOR receiver (default) The transceiver is turned on, and when transmitting data, a wake-up code for a certain period of time is added.		
			1	WOR transmitter The DTU cannot transmit data, and it works in WOR monitoring mode. The monitoring period is shown below (WOR period), which can save a lot of power consumption.		
2	1	0	WOR Cycle		Only valid for mode 1;  Cycle T= (1+WOR)*500ms, the maximum is 4000ms, the minimum is 500ms;  The longer the WOR monitoring interval period, the lower the average power consumption, but the greater the data delay;  Both sender and receiver must agree (very important)	
0	0	0	500ms			
0	0	1	1000ms			
0	1	0	1500ms			
0	1	1	2000ms			
1	0	0	2500ms			
1	0	1	3000ms			
1	1	0	3500ms			



			1	1	1	4000ms	
07H	Write	CRYPT_H	High byte of key (default 0)			Only write, read returns 0; Used for encryption to avoid interception of wireless data in the air by similar DTUs; The DTU will use these two bytes as a calculation factor to transform and encrypt the air wireless signal.	
08H	Write	CRYPT_L	Low byte of key (default 0)				
80H ~ 86H	Read	PID	Product information 7 bytes			Product information 7 bytes	

### 6.3 Factory default parameters

Model	Factory default parameter value: C0 00 00 62 00 00						
DTU Model	Frequency	Address	Channel	Air Speed	Baud Rate	Serial Format	Transmit Power
E95-DTU(400SL22-485)	433.125MHz	0x0000	0x17	2.4kbps	9600	8N1	22dBm

## 7. Relay Network Mode Use

No.	Relay mode description
1	After setting the relay mode through the configuration mode, switch to the normal mode and the relay starts to work.
2	In relay mode, ADDH and ADDL are no longer used as radio addresses, but correspond to NETID forwarding and pairing respectively. If one network is received, it will be forwarded to another network. The network ID of the repeater itself is invalid.
3	In the relay mode, the relay station cannot send and receive data, and cannot perform low-power operation.
4	When the user enters other modes from mode 3 (sleep mode) or is in the reset process, the radio will reset the user parameters, during which AUX outputs low level.

Description of relay networking rules:

- Forwarding rules, the relay can forward data in both directions between two NETIDs.
- In the relay mode, ADDH\ADDL is no longer used as a DTU address, but as a NETID forwarding pairing.

As shown:

① Primary relay

"Node 1" NETID is 08.

"Node 2" NETID is 33.

The ADDH\ADDL of relay 1 are 08 and 33 respectively.

So, the signal sent by node 1 (08) can be forwarded to node 2 (33)

At the same time, node 1 and node 2 have the same address, so the data sent by node 1 can be received by node 2.

② Secondary relay

The ADDH\ADDL of relay 2 are 33 and 05 respectively.

So, Relay 2 can forward the data of Relay 1 to the network NETID: 05.

Therefore, node 3 and node 4 can receive node 1 data. Node 4 normally outputs data, and node 3 has a different address from node 1, so no data is output.

③ Two-way relay

As shown in the configuration: the data sent by node 1 can be received by nodes 2 and 4, and the data sent by nodes 2 and 4 can also be received by node 1.

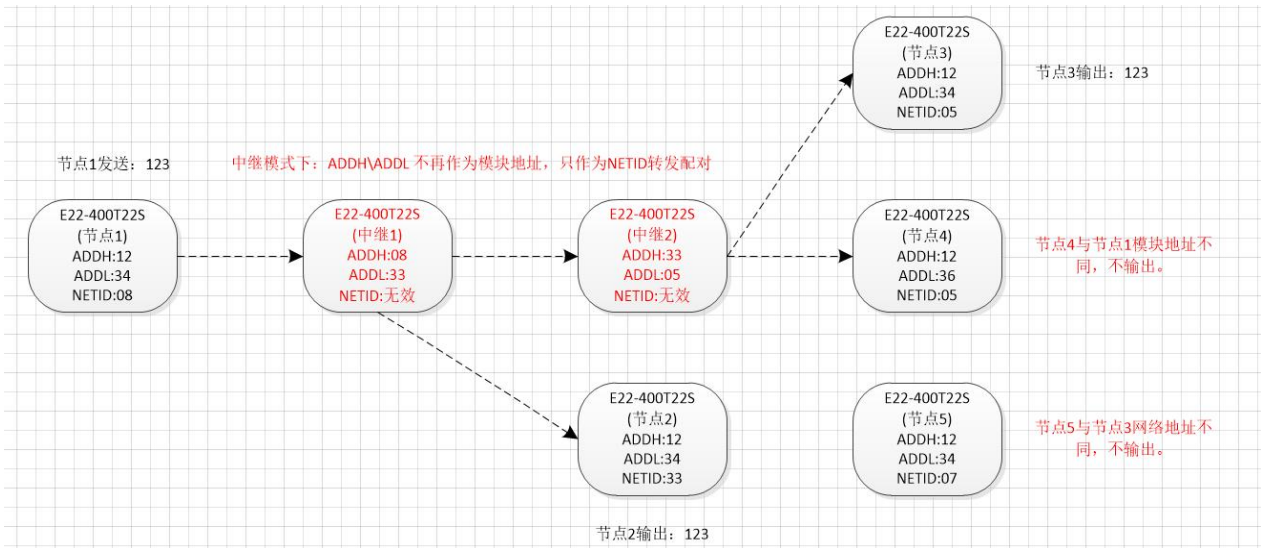

## 8. PC Configuration Instructions

- The following figure shows the display interface of the E95-DTU (400SL22-485) configuration host computer. The user can switch to the configuration mode through the MODE button, and quickly configure and read the parameters on the host computer.

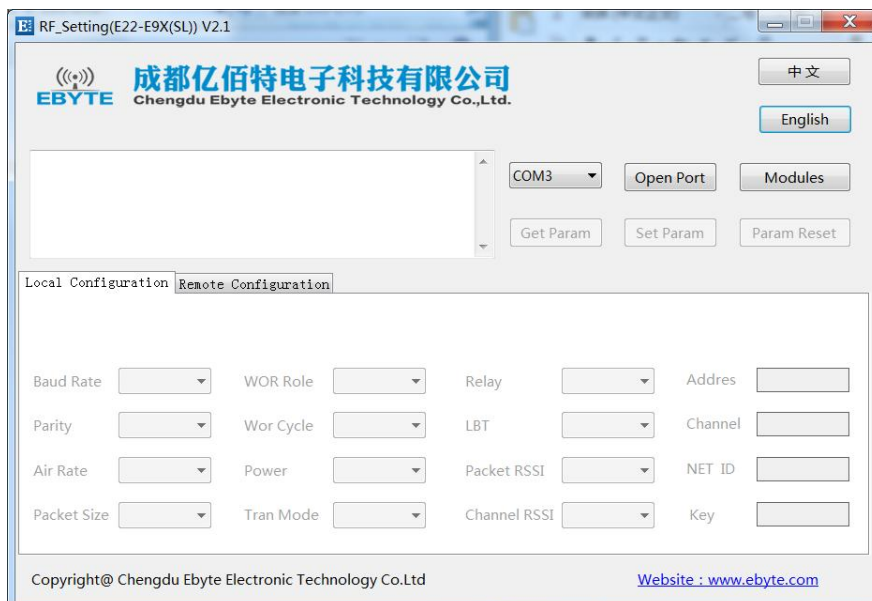

- In the configuration of the host computer, the DTU address, frequency channel, network ID, and key are all in decimal display mode, and the value range of each parameter:  
 Network Address: 0~65535  
 Frequency Channel: 0~83  
 Network ID: 0~255  
 Key: 0~65535
- When using the host computer to configure the relay mode, the user needs to pay attention. Since the parameters in the host computer are in decimal display mode, the DTU address and network ID need to be converted when filling in. If the network ID input by the transmitting terminal A is 02, and the network ID input by the receiving terminal B is 10, when the relay terminal R sets the radio address, the hexadecimal value 0X020A is converted to the decimal value 522 as the relay terminal R. Radio address. That is, the radio address value that needs to be filled in by the relay terminal R at this time is 522.

## 9. Program the DTU

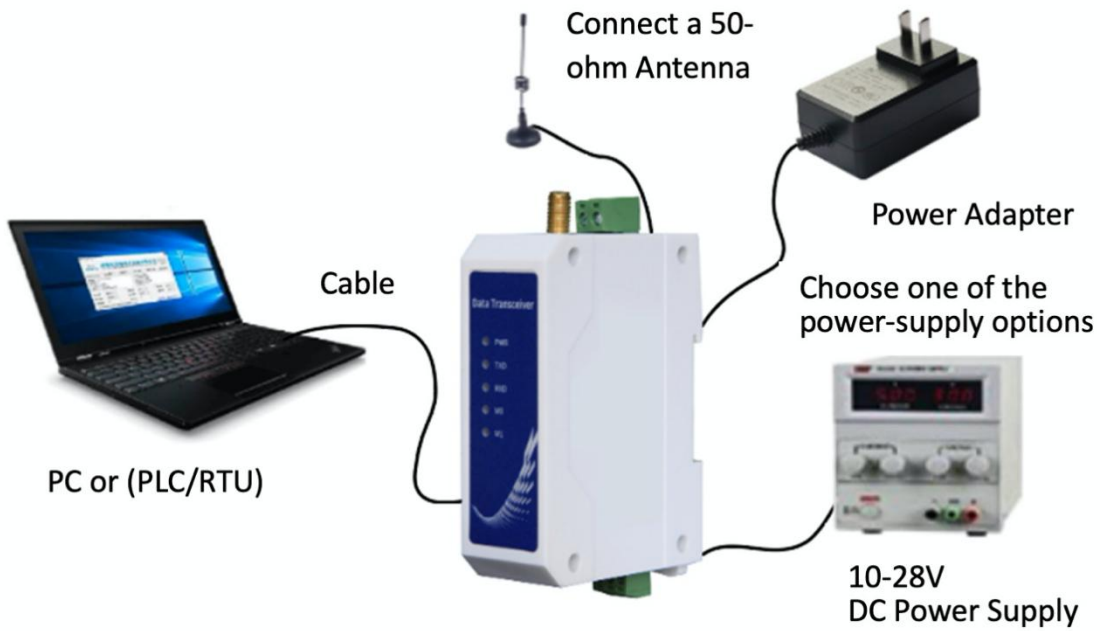

Operating Mode	M1	M0	Remark
Configuration mode	Light On	Light Off	Only use the configuration software to program the DTU in the current mode

- 1、 Programming can only be carried out in a specific working mode (see the above table). If the programming fails, please confirm whether the working mode of the DTU is correct.
- 2、 If you don't need complicated programming to open the E95-DTU (400SL22-485) configuration software, you can modify the relevant parameters.

## 10. Connection Diagram in Test and Practical Application

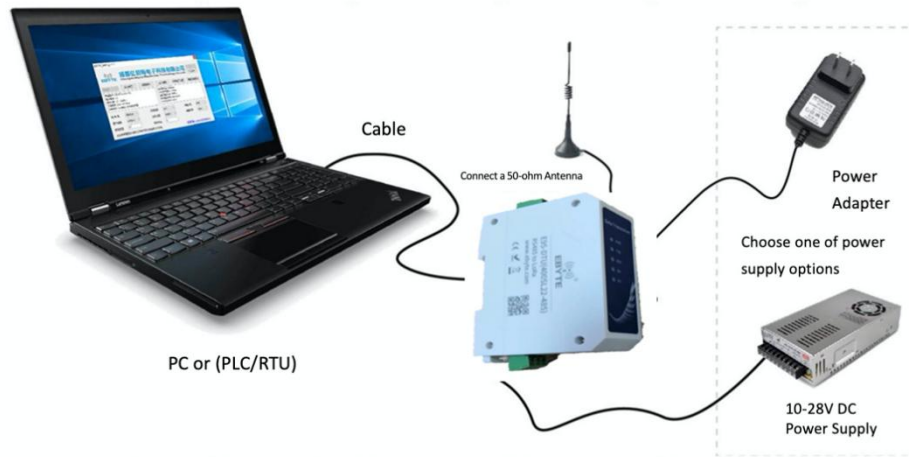

## 11. Related Products

Model	Interface Type	Frequency Hz	Transmit power dBm	Distance km	Features
<a href="#">E95-DTU(400SL30-485)</a>	RS485	410.125/493.125M	30	10	Cost-effective LoRa, Rail Type, RS232, E90-DTU SL series intercommunication
<a href="#">E95-DTU(400F20-485)</a>	RS485	410/510M	20	1	Ultra-low price digital DTU
<a href="#">E95-DTU(433L20-485)</a>	RS485	410/441M	20	8	Cost-effective LoRa, Rail Type, RS485, E90-DTU L series intercommunication
<a href="#">E95-DTU(433L30-485)</a>	RS485	410/441M	30	8	Cost-effective LoRa, Rail Type, RS485, E90-DTU L series intercommunication
<a href="#">E95-DTU(433L20-232)</a>	RS232	410/441M	20	8	Cost-effective LoRa, Rail Type, RS232, E90-DTU L series intercommunication
<a href="#">E95-DTU(433L30-232)</a>	RS232	410/441M	30	8	Cost-effective LoRa, Rail Type, RS232, E90-DTU L series intercommunication
<a href="#">E95-DTU(400F20-232)</a>	RS232	410/510M	20	1	Ultra-low price digital DTU
<a href="#">E95-DTU(400SL22-232)</a>	RS232	410.125/493.125M	22	5	Cost-effective LoRa, Rail Type, RS232, E90-DTU SL series intercommunication
<a href="#">E95-DTU(400SL30-232)</a>	RS232	410.125/493.125M	30	10	Cost-effective LoRa, Rail Type, RS232, E90-DTU SL series intercommunication
<a href="#">E95-DTU(400F20-485)</a>	RS485	410/510M	20	1	Ultra-low price digital DTU

## 12. Practical Application

Ebyte DTU is suitable for all kinds of point-to-point and point-to-multipoint wireless data transmission systems, such as smart homes, IoT transformation, power load monitoring, distribution automation, hydrology and water regime monitoring and reporting, tap water pipe network monitoring, urban street lights Industrial automation such as monitoring, air defense alarm control, railway signal monitoring, railway water supply centralized control, oil and gas supply pipeline network monitoring, GPS positioning system, remote meter reading, electronic hoisting scale, automatic target reporting, earthquake observation and reporting, fire prevention and theft prevention, environmental monitoring, etc. System, as shown below:

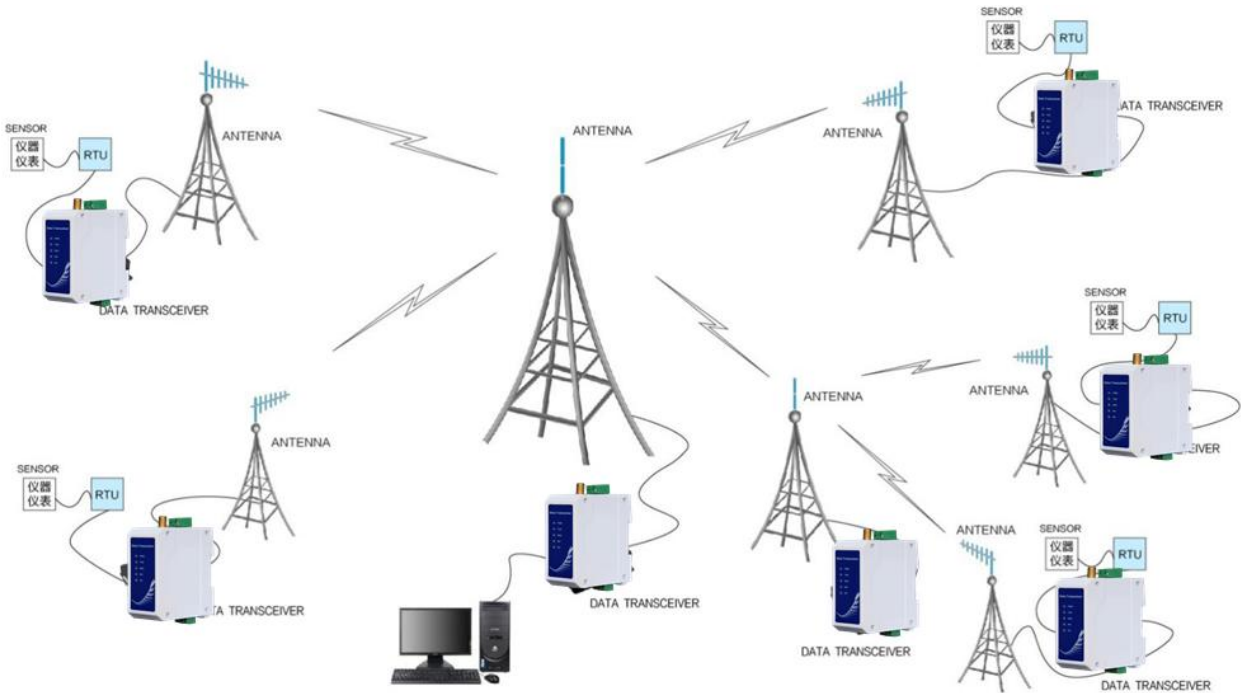

## 13. Precautions for Use

1. Please take good care of the warranty card of the device. The warranty card contains the factory number (and important technical parameters) of the device, which has important reference value for the user's future maintenance and new equipment.
2. During the warranty period, if the DTU is damaged due to the quality of the product itself rather than man-made damage or natural disasters such as lightning strikes, it enjoys free warranty; please do not repair by yourself, and contact our company if there is a problem. Ebyte provides first-class After-sales service.
3. Do not operate this DTU in the vicinity of some flammable places (such as coal mines) or explosive dangerous objects (such as detonators for detonation).
4. A suitable DC stabilized power supply should be selected, which requires strong anti-high frequency interference, small ripple, and sufficient load capacity; preferably, it should also have over-current, over-voltage protection and lightning protection functions to ensure that the DTU is normal jobs.
5. Do not use it in a working environment that exceeds the environmental characteristics of the DTU, such as high temperature, humidity, low temperature, strong electromagnetic field or dusty environment.
6. Don't let the DTU continuously be in full load transmitting state, otherwise the transmitter may be burnt out.
7. The ground wire of the DTU should be well connected with the ground wire of the external equipment (such as PC, PLC, etc.) and the ground wire of the power supply, otherwise the communication interface will be burnt easily; do not plug or unplug the serial port with power on.
8. When testing a DTU, you must connect a matching antenna or a 50Ω dummy load, otherwise the transmitter will be easily damaged; if the antenna is connected, the distance between the human body and the antenna should be more than 2 meters to avoid injury. Touch the antenna when transmitting.
9. Wireless data transmission stations often have different communication distances in different environments. The communication distance is often affected by temperature, humidity, obstacle density, obstacle volume, and electromagnetic environment; in order to ensure stable communication, it is recommended to reserve more than 50% The communication distance margin.
10. If the measured communication distance is not ideal, it is recommended to analyze and improve the communication distance from the antenna quality and antenna installation method. You can also contact support@cdebyte.com for help.
11. When selecting the power supply, in addition to keeping 50% of the current margin as recommended, it should also be noted that its ripple must not exceed 100mV.
12. Wireless communication products need to be connected to an impedance-matched antenna to work normally. Even short-term tests cannot be omitted. Product damage caused by this reason will not be covered by the warranty.

## Important Statement

1. Ebyte reserves the right of final interpretation and modification of all contents in this manual.
2. Due to the continuous improvement of product hardware and software, this manual may be changed without prior notice. The latest version of the manual shall prevail.
3. It is everyone's responsibility to protect the environment: In order to reduce the use of paper, this manual only prints the Chinese part, and the English manual only provides electronic documents. If necessary, please download it from our official website; in addition, if not specifically requested by the user, the user can order in bulk. At the time, we only provide product manuals according to a certain percentage of the order quantity, not every DTU is matched with it, please understand.

## Revision History

Version	Date	Description	Issued By
1.0	2020-08-17	Original Version	ken

## About us

Technical support: [support@cdebyte.com](mailto:support@cdebyte.com)

Documents and RF Setting download link: <https://www.cdebyte.com>

Thank you for using Ebyte products! Please contact us with any questions or suggestions: [info@cdebyte.com](mailto:info@cdebyte.com)

-----  
Official hotline:028-61399028

Web:<https://www.cdebyte.com>

Address: B5 Mould Park, 199# Xiqu Ave, High-tech District, Sichuan, China



**Chengdu Ebyte Electronic Technology Co.,Ltd.**