

# General Purpose Transistor

- Pb-Free Package May be Available. The G-Suffix Denotes a Pb-Free Lead Finish

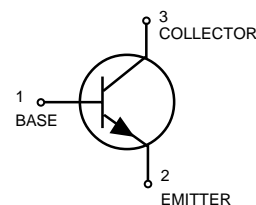
## LMBT3904LT1

### ORDERING INFORMATION

Device	Package	Shipping
LMBT3904LT1	SOT-23	3000/Tape & Reel
LMBT3904LT1G	SOT-23	3000/Tape & Reel

### MAXIMUM RATINGS

Rating	Symbol	Value	Unit
Collector-Emitter Voltage	$V_{CEO}$	40	Vdc
Collector-Base Voltage	$V_{CBO}$	60	Vdc
Emitter-Base Voltage	$V_{EBO}$	6.0	Vdc
Collector Current — Continuous	$I_C$	200	mAdc



### THERMAL CHARACTERISTICS

Characteristic	Symbol	Max	Unit
Total Device Dissipation FR-5 Board, (1) $T_A = 25^\circ\text{C}$	$P_D$	225	mW
Derate above $25^\circ\text{C}$		1.8	mW/ $^\circ\text{C}$
Thermal Resistance, Junction to Ambient	$R_{\theta JA}$	556	$^\circ\text{C}/\text{W}$
Total Device Dissipation Alumina Substrate, (2) $T_A = 25^\circ\text{C}$	$P_D$	300	mW
Derate above $25^\circ\text{C}$		2.4	mW/ $^\circ\text{C}$
Thermal Resistance, Junction to Ambient	$R_{\theta JA}$	417	$^\circ\text{C}/\text{W}$
Junction and Storage Temperature	$T_J, T_{stg}$	-55 to +150	$^\circ\text{C}$

### DEVICE MARKING

LMBT3904LT1 = 1AM

### ELECTRICAL CHARACTERISTICS ( $T_A = 25^\circ\text{C}$ unless otherwise noted.)

Characteristic	Symbol	Min	Max	Unit
----------------	--------	-----	-----	------

### OFF CHARACTERISTICS

Collector-Emitter Breakdown Voltage(3) ( $I_C = 1.0 \text{ mAdc}$ )	$V_{(BR)CEO}$	40	—	Vdc
Collector-Base Breakdown Voltage ( $I_C = 10 \mu\text{Adc}$ )	$V_{(BR)CBO}$	60	—	Vdc
Emitter-Base Breakdown Voltage ( $I_E = 10 \mu\text{Adc}$ )	$V_{(BR)EBO}$	6.0	—	Vdc
Base Cutoff Current ( $V_{CE} = 30 \text{ Vdc}, V_{EB} = 3.0 \text{ Vdc}$ )	$I_{BL}$	—	50	nAdc
Collector Cutoff Current ( $V_{CE} = 30 \text{ Vdc}, V_{BE} = 3.0 \text{ Vdc}$ )	$I_{CEX}$	—	50	nAdc

- FR-5 =  $1.0 \times 0.75 \times 0.062 \text{ in.}$
- Alumina =  $0.4 \times 0.3 \times 0.024 \text{ in.}$  99.5% alumina.
- Pulse Test: Pulse Width  $\leq 300 \mu\text{s}$ , Duty Cycle  $\leq 2.0\%$ .

**LMBT3904LT1**
**ELECTRICAL CHARACTERISTICS** ( $T_A = 25^\circ\text{C}$  unless otherwise noted) (Continued)

Characteristic	Symbol	Min	Max	Unit
<b>DC CHARACTERISTICS (3)</b>				
DC Current Gain(1) ( $I_C = 0.1 \text{ mAdc}$ , $V_{CE} = 1.0 \text{ Vdc}$ )	$h_{FE}$	40	—	—
( $I_C = 1.0 \text{ mAdc}$ , $V_{CE} = 1.0 \text{ Vdc}$ )		70	—	
( $I_C = 10 \text{ mAdc}$ , $V_{CE} = 1.0 \text{ Vdc}$ )		100	300	
( $I_C = 50 \text{ mAdc}$ , $V_{CE} = 1.0 \text{ Vdc}$ )		60	—	
( $I_C = 100 \text{ mAdc}$ , $V_{CE} = 1.0 \text{ Vdc}$ )		30	—	
Collector–Emitter Saturation Voltage ( $I_C = 10 \text{ mAdc}$ , $I_B = 1.0 \text{ mAdc}$ )(3)	$V_{CE(sat)}$	—	0.2	Vdc
( $I_C = 50 \text{ mAdc}$ , $I_B = 5.0 \text{ mAdc}$ )		—	0.3	
Base–Emitter Saturation Voltage(3) ( $I_C = 10 \text{ mAdc}$ , $I_B = 1.0 \text{ mAdc}$ )	$V_{BE(sat)}$	0.65	0.85	Vdc
( $I_C = 50 \text{ mAdc}$ , $I_B = 5.0 \text{ mAdc}$ )		—	0.95	

**SMALL–SIGNAL CHARACTERISTICS**

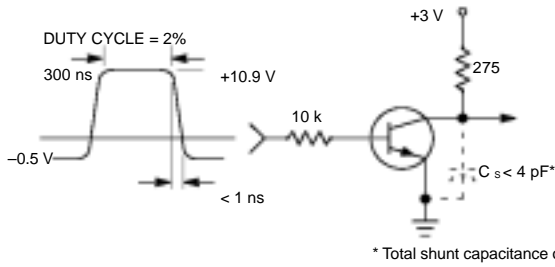
Current–Gain — Bandwidth Product ( $I_C = 10 \text{ mAdc}$ , $V_{CE} = 20 \text{ Vdc}$ , $f = 100 \text{ MHz}$ )	$f_T$	300	—	MHz
Output Capacitance ( $V_{CB} = 5.0 \text{ Vdc}$ , $I_E = 0$ , $f = 1.0 \text{ MHz}$ )	$C_{obo}$	—	4.0	pF
Input Capacitance ( $V_{BE} = 0.5 \text{ Vdc}$ , $I_C = 0$ , $f = 1.0 \text{ MHz}$ )	$C_{ibo}$	—	8.0	pF
Input Impedance ( $V_{CE} = 10 \text{ Vdc}$ , $I_C = 1.0 \text{ mAdc}$ , $f = 1.0 \text{ kHz}$ )	$h_{ie}$	1.0	10	pF
Voltage Feedback Ratio ( $V_{CE} = 10 \text{ Vdc}$ , $I_C = 1.0 \text{ mAdc}$ , $f = 1.0 \text{ kHz}$ )	$h_{re}$	0.5	8.0	$\times 10^{-4}$
Small–Signal Current Gain ( $V_{CE} = 10 \text{ Vdc}$ , $I_C = 1.0 \text{ mAdc}$ , $f = 1.0 \text{ kHz}$ )	$h_{fe}$	100	400	—
Output Admittance ( $V_{CE} = 10 \text{ Vdc}$ , $I_C = 1.0 \text{ mAdc}$ , $f = 1.0 \text{ kHz}$ )	$h_{oe}$	1.0	40	$\text{mhos}$
Noise Figure ( $V_{CE} = 5.0 \text{ Vdc}$ , $I_C = 100 \mu\text{Adc}$ , $R_S = 1.0 \text{ k}\Omega$ , $f = 1.0 \text{ kHz}$ )	NF	—	5.0	dB

**SWITCHING CHARACTERISTICS**

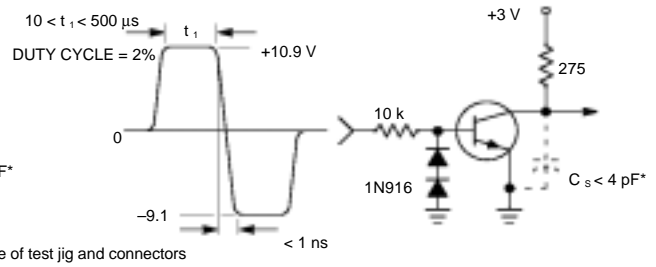
Delay Time ( $V_{CC} = 3.0 \text{ Vdc}$ , $V_{BE} = -0.5 \text{ Vdc}$ )	$t_d$	—	35	ns
Rise Time ( $I_C = 10 \text{ mAdc}$ , $I_{B1} = 1.0 \text{ mAdc}$ )	$t_r$	—	35	ns
Storage Time ( $V_{CC} = 3.0 \text{ Vdc}$ )	$t_s$	—	200	ns
Fall Time ( $I_C = 10 \text{ mAdc}$ , $I_{B1} = I_{B2} = 10 \text{ mAdc}$ )	$t_f$	—	50	ns

 3. Pulse Test: Pulse Width  $\leq 300 \mu\text{s}$ , Duty Cycle  $\leq 2.0\%$ .

**LMBT3904LT1**

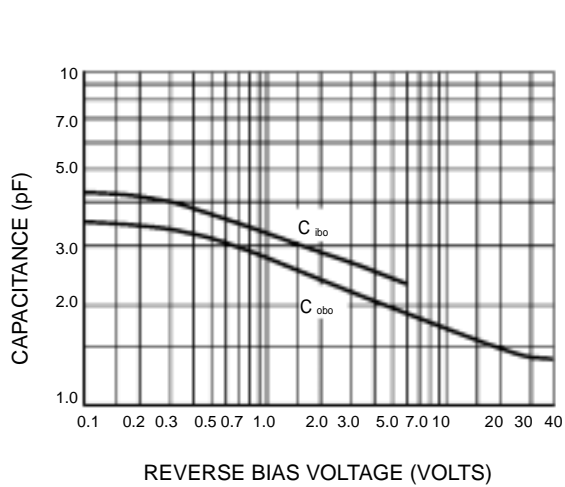


**Figure 1. Delay and Rise Time  
Equivalent Test Circuit**

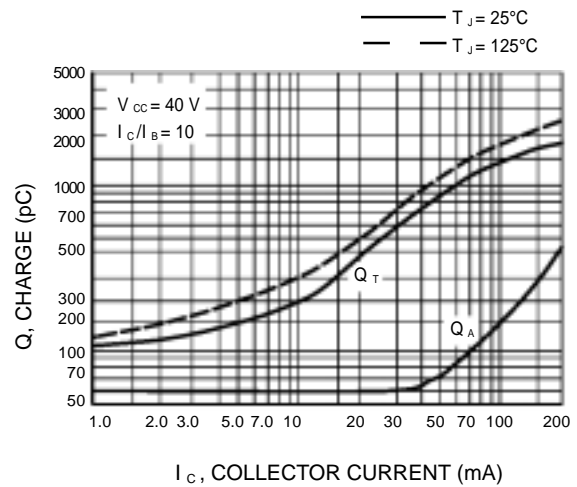


**Figure 2. Storage and Fall Time  
Equivalent Test Circuit**

**TYPICAL TRANSIENT CHARACTERISTICS**

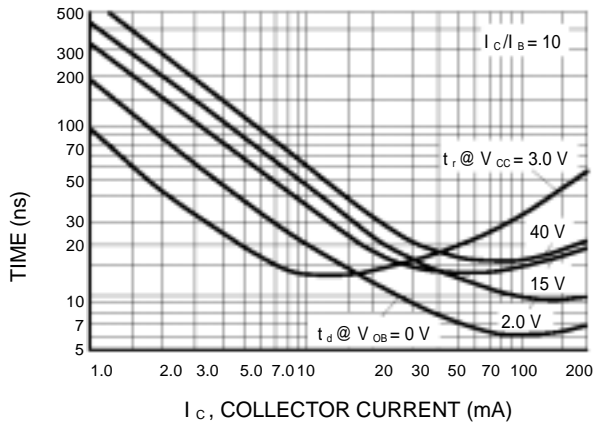


**Figure 3. Capacitance**

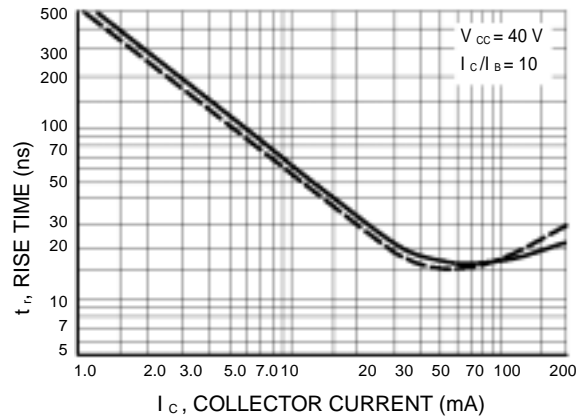


**Figure 4. Charge Data**

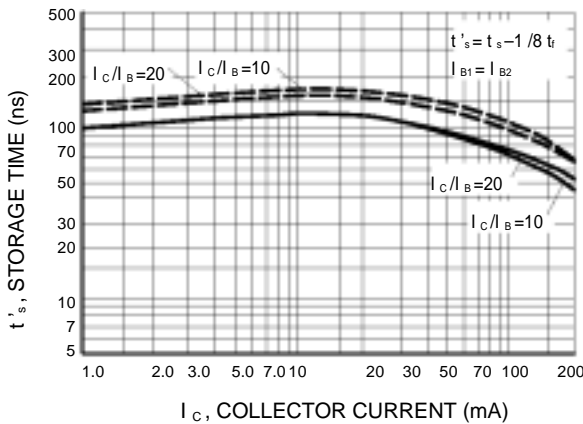
**LMBT3904LT1**



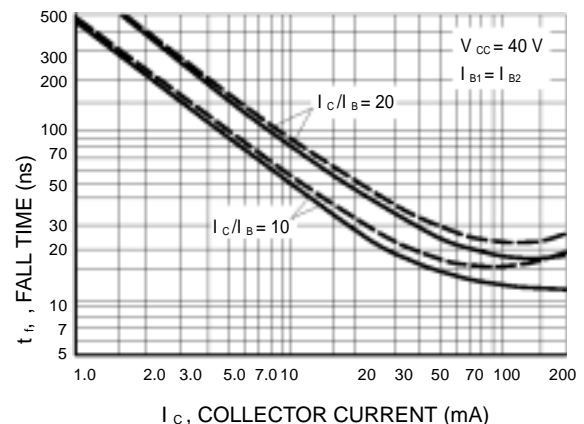
**Figure 5. Turn-On Time**



**Figure 6. Rise Time**



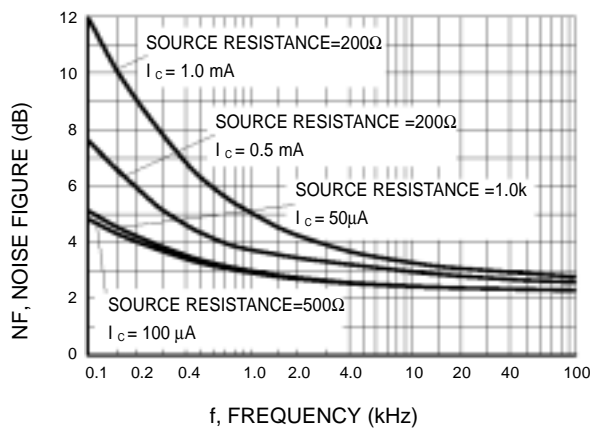
**Figure 7. Storage Time**



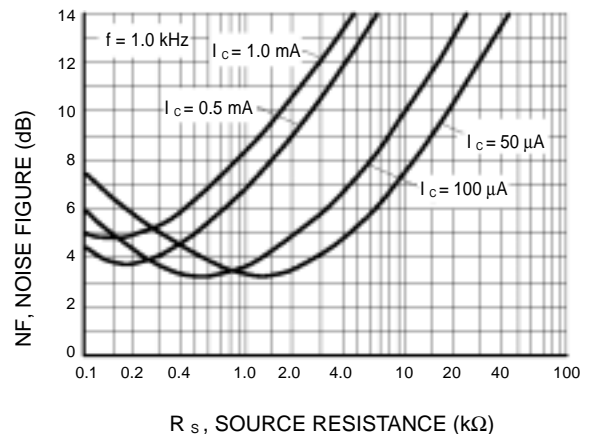
**Figure 8. Fall Time**

**TYPICAL AUDIO SMALL-SIGNAL CHARACTERISTICS  
NOISE FIGURE VARIATIONS**

( $V_{CE} = 5.0 \text{ Vdc}$ ,  $T_A = 25^\circ\text{C}$ , Bandwidth = 1.0 Hz)



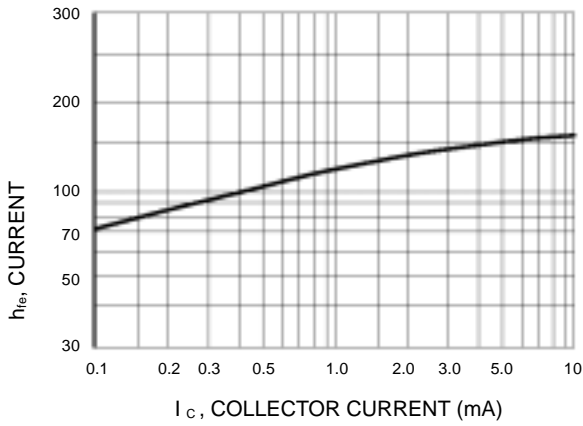
**Figure 9.**



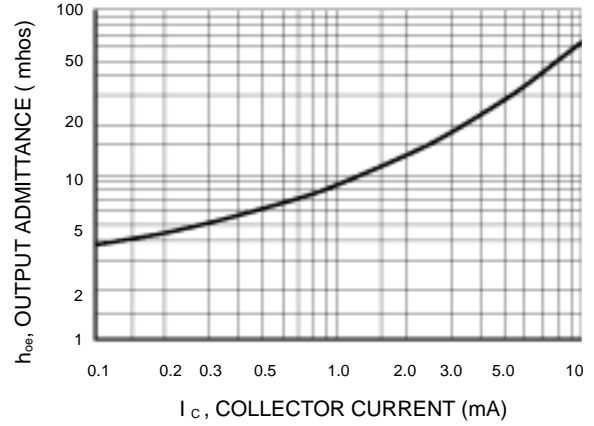
**Figure 10.**

**h PARAMETERS**

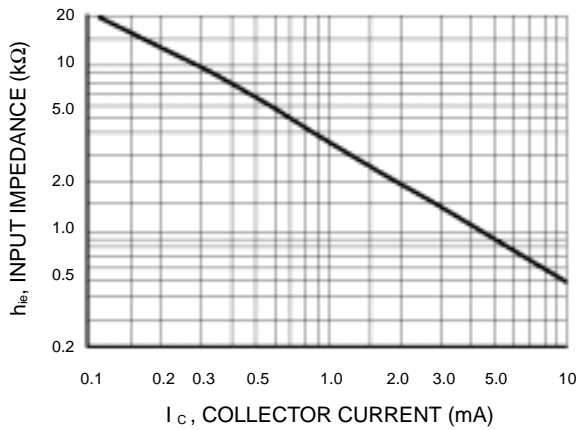
( $V_{CE} = 10 \text{ Vdc}$ ,  $f = 1.0 \text{ kHz}$ ,  $T_A = 25^\circ\text{C}$ )



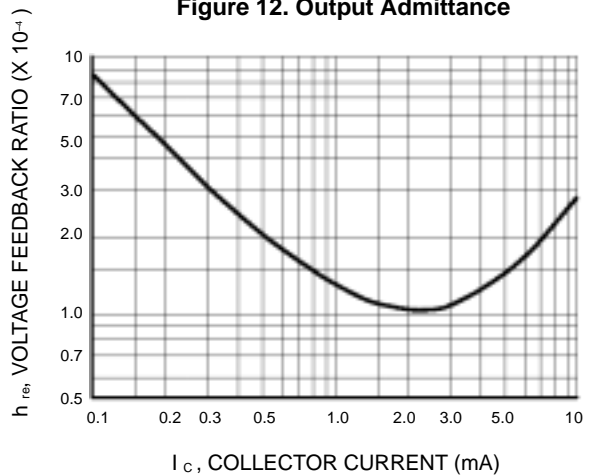
**Figure 11. Current Gain**



**Figure 12. Output Admittance**

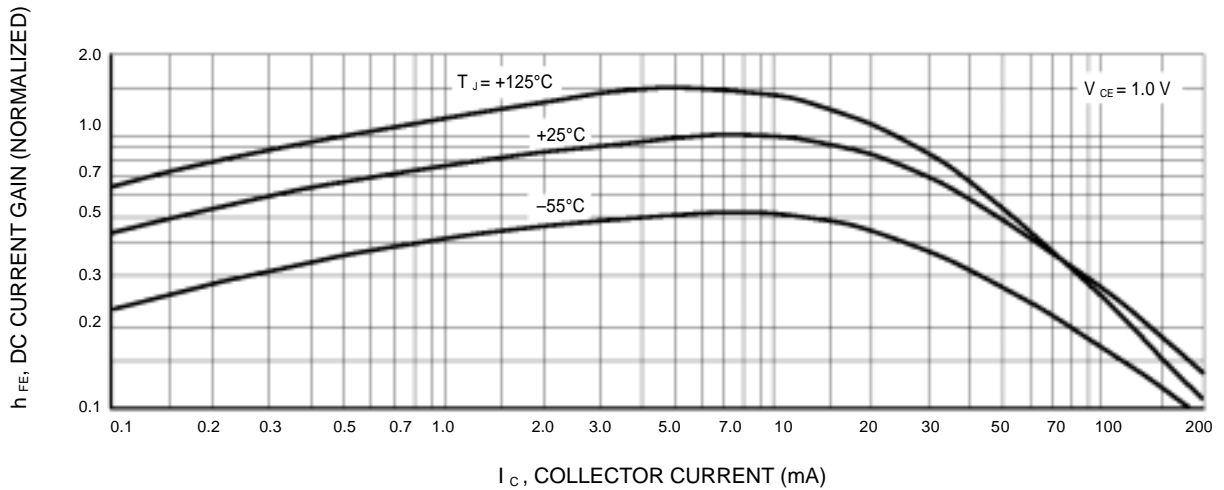


**Figure 13. Input Impedance**



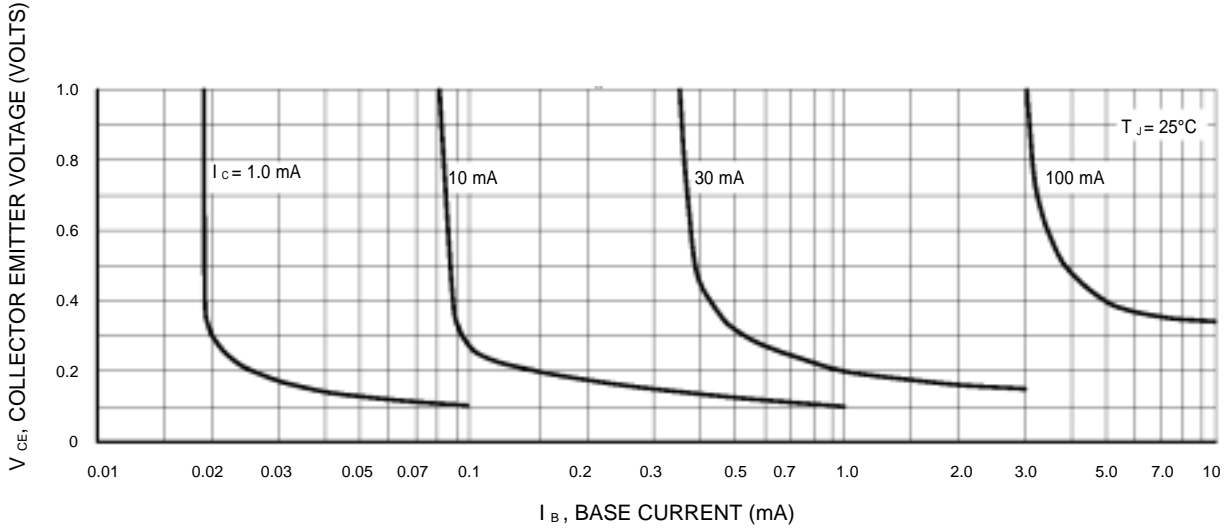
**Figure 14. Voltage Feedback Ratio**

**TYPICAL STATIC CHARACTERISTICS**

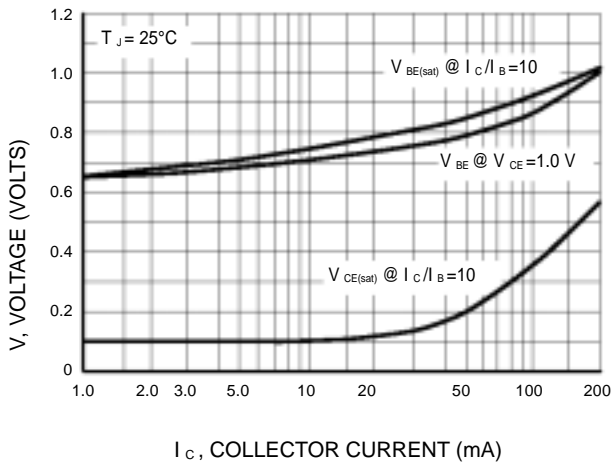


**Figure 15. DC Current Gain**

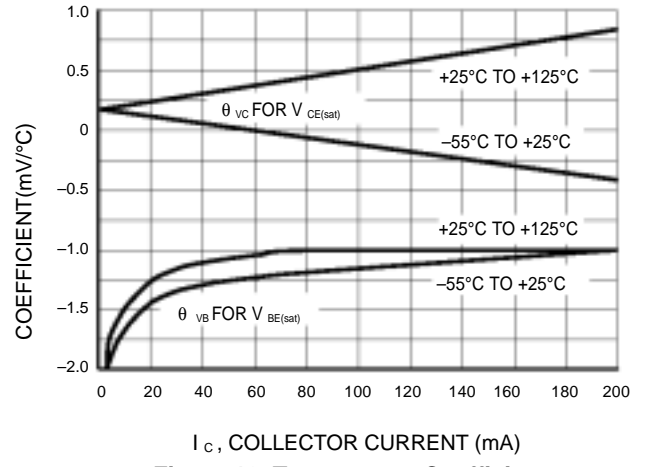
**LMBT3904LT1**



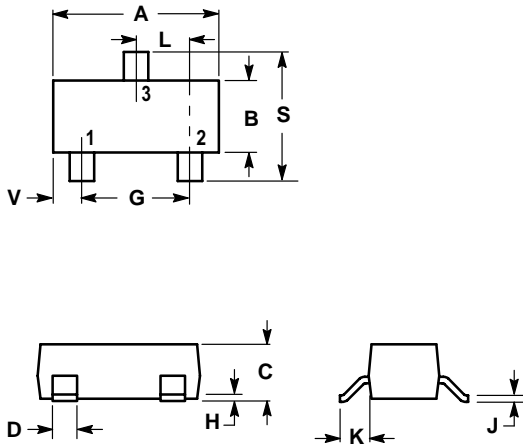
**Figure 16. Collector Saturation Region**



**Figure 17. "ON" Voltages**



**Figure 18. Temperature Coefficients**

**LMBT3904LT1**
**SOT-23**

**NOTES:**

1. DIMENSIONING AND TOLERANCING PER ANSI Y14.5M, 1982.
2. CONTROLLING DIMENSION: INCH.

DIM	INCHES		MILLIMETERS	
	MIN	MAX	MIN	MAX
<b>A</b>	0.1102	0.1197	2.80	3.04
<b>B</b>	0.0472	0.0551	1.20	1.40
<b>C</b>	0.0350	0.0440	0.89	1.11
<b>D</b>	0.0150	0.0200	0.37	0.50
<b>G</b>	0.0701	0.0807	1.78	2.04
<b>H</b>	0.0005	0.0040	0.013	0.100
<b>J</b>	0.0034	0.0070	0.085	0.177
<b>K</b>	0.0140	0.0285	0.35	0.69
<b>L</b>	0.0350	0.0401	0.89	1.02
<b>S</b>	0.0830	0.1039	2.10	2.64
<b>V</b>	0.0177	0.0236	0.45	0.60

- PIN 1. BASE  
 2. EMITTER  
 3. COLLECTOR

