



EBYTE

成都亿佰特电子科技有限公司

Chengdu Ebyte Electronic Technology Co.,Ltd.

Wireless Modem

USER MANUAL

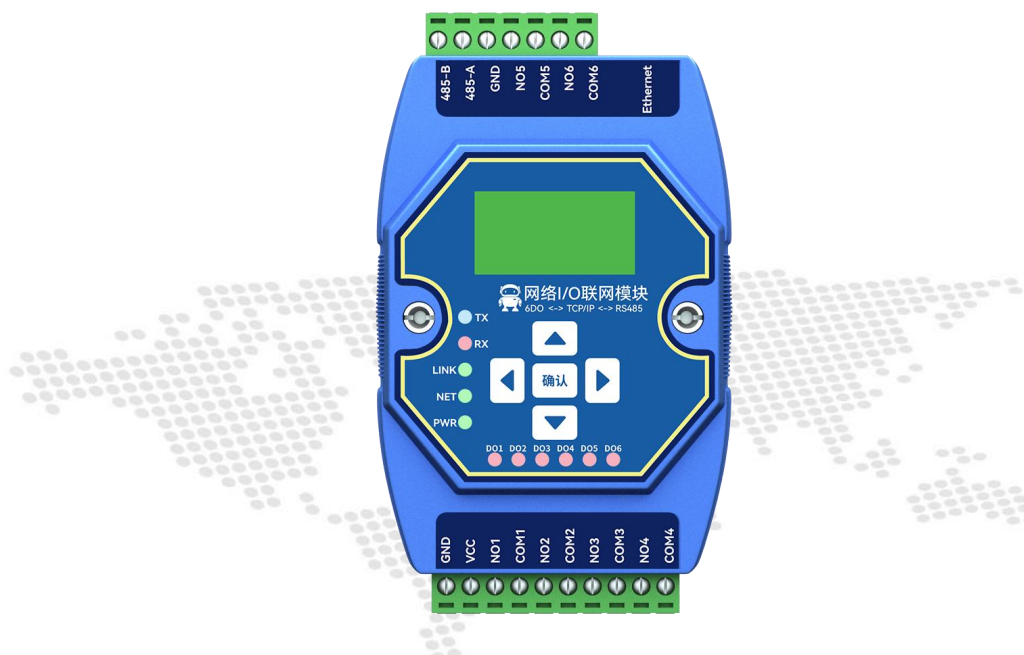

ME31-XXAX0060

Network I/O Networking Module

This manual may be updated with product improvements, please refer to the latest version of the manual! Chengdu Yibaite Electronic Technology Co., Ltd. reserves the final interpretation and modification rights for all contents in this instruction!

Contents

I. Overview	3
1.1 Product Introduction	3
1.2 Functional Features	3
1.3 Product Application Topology Diagram	3
II.Quick use	5
2.1 Device preparation	5
2.2 Device connection	6
2.2.1 RS485 connection	6
2.2.2 Relay output connection	6
2.2.3 Simple use	7
2.3 Parameter Configuration	7
2.4 Control Testing	8
2.4.1 Modbus TCP control	8
2.4.2 Modbus RTU control	9
III. Technical Specification	10
3.1 Specifications	10
3.2 Device Default Parameters	10
3.3 Mechanical Dimensional Drawing	11
3.4 Port and indicator light description	12
IV. Product Function Introduction	14
4.1 DO output	14
4.1.1. Input count	14
4.1.2. Level output	14
4.1.3. Pulse output	14
4.1.4. Follow mode	14
4.1.5. Reverse follow mode	15
4.1.6. Trigger toggle mode	15
4.1.7. Power-on state	15
4.2 Modbus Gateway	15
4.2.1. Modbus TCP/RTU protocol conversion	15
4.2.2. Modbus Address Filtering	15
4.2.3. Modbus TCP Protocol Data Frame Description	16
4.2.4. Modbus RTU protocol data frame description	16
4.3 Active upload	16
4.4 Custom Module Information	17
4.4.1. Modbus Address	17
4.4.2. Module Name	17
4.4.3. Network parameters	17
4.4.4. Serial Port Parameters	17
4.5 OLED display and parameter configuration	18
4.5.1. Information Display Interface	18

4.5.2. Equipment parameter display interface	18
4.5.3. Equipment Parameter Configuration Interface	19
4.5.4. Screen Sleep	19
4.6 MODBUS parameter configuration	20
4.6.1. DO Register List	20
4.6.2. Module related registers	21
4.6.3. Network related registers	21
4.6.4. Examples of Modbus command operation instructions	22
V. Configuration Software	25
5.1. Acquisition and Control	25
5.2. Parameter configuration interface	26

I. Overview

1.1 Product Introduction

ME31-XXAX0060 is equipped with 6-way A-type relay output, and supports Modbus TCP protocol or Modbus RTU protocol for acquisition and control. At the same time, the device is also a network I/O networking module that can be used as a simple Modbus gateway (automatically send commands with non-local Modbus addresses through the serial port/network port).



1.2 Functional Features

- Support standard Modbus RTU protocol and Modbus TCP protocol;
- Support various configuration software/PLC/touch screen;
- RS485 acquisition control I/O;
- RJ45 acquisition control I/O, support 4-way host access;
- Support OLED display to display status information, and configure device parameters through buttons;
- 6-way switch output DO (A-type relay);
- Switch output (DO) supports level mode, pulse mode, follow mode, reverse follow mode, trigger flip mode;
- Support custom Modbus address setting;
- Support 8 common baud rate configurations;
- Support DHCP and static IP;
- Support DNS function, domain name resolution;
- Support Modbus gateway function;

1.3 Product Application Topology Diagram

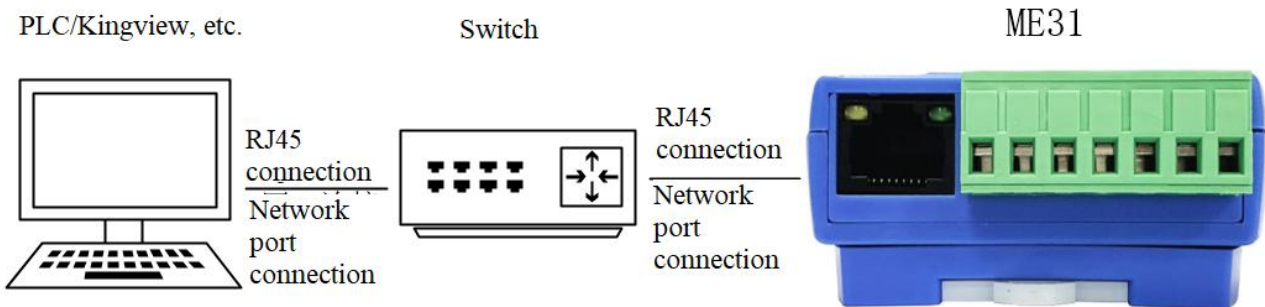

Network interface application topology diagram

PLC/Kingview, etc.



RS485
Serial port
connection

ME31







Serial port application topology diagram

II.Quick use

【Note】 This test needs to be carried out with the default factory parameters.

2.1 Device preparation

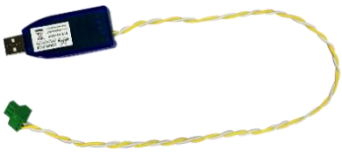
The following table lists the items required for this test:

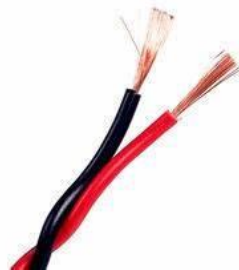
		
<p>ME31-XXAX0060</p>	<p>12V switching power supply</p>	<p>USB to RS485 Cable</p>
		
<p>A computer</p>	<p>A network cable</p>	<p>Several cables</p>

2.2 Device connection

2.2.1 RS485 connection

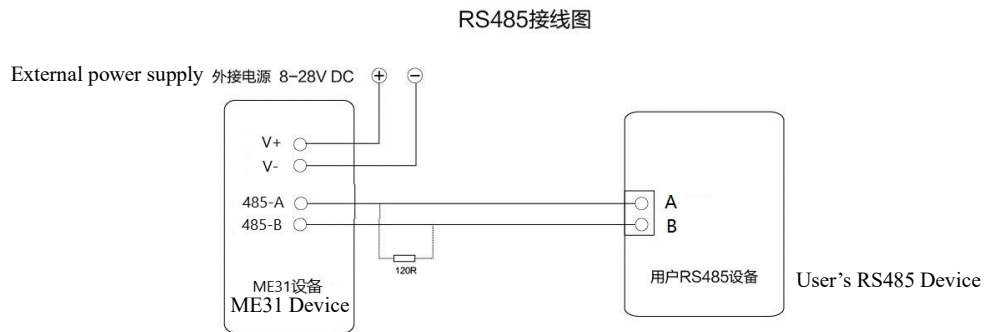

Note: When the 485 bus high-frequency signal is transmitted, the signal wavelength is shorter than the transmission line, and the signal will form a reflected wave at the end of the transmission line, which will interfere with the original signal. Therefore, it is necessary to add a terminal resistor at the end of the transmission line so that the signal does not reflect after reaching the end of the transmission line. The terminal resistance should be the same as the impedance of the communication cable, the typical value is 120 ohms. Its function is to match the bus impedance and improve the anti-interference and reliability of data communication.

2.2.2 Relay output connection

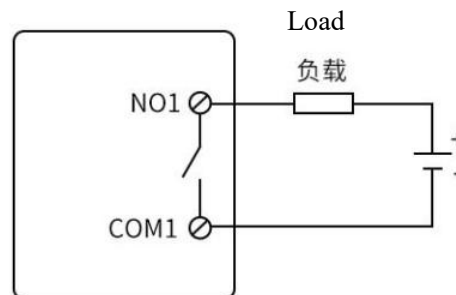

2.2.3 Simple use

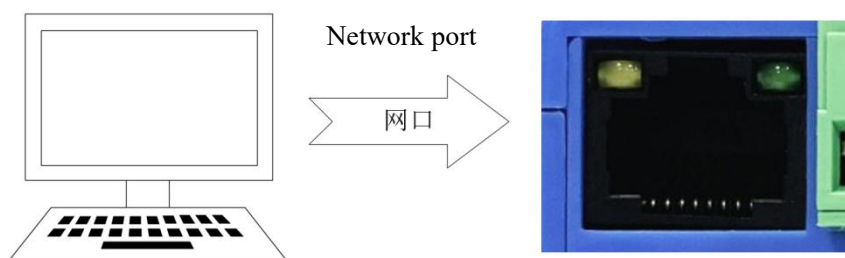

Wiring: The computer is connected to the RS485 interface of ME31-XXAX0060 through USB to RS485, A is connected to A, and B is connected to B.

Networking: Insert the network cable into the RJ45 port and connect to the PC.

Power supply: Use DC-12V switching power supply (DC 8~28V) to power ME31-XXAX0060.

2.3 Parameter Configuration

Step 1: Modify the IP address of the computer to be consistent with the device. Here I am modifying it to 192.168.3.100 to ensure that it is on the same network segment as the device and that the IP is different. If you cannot connect to the device after the above steps, please turn off the firewall and try again;

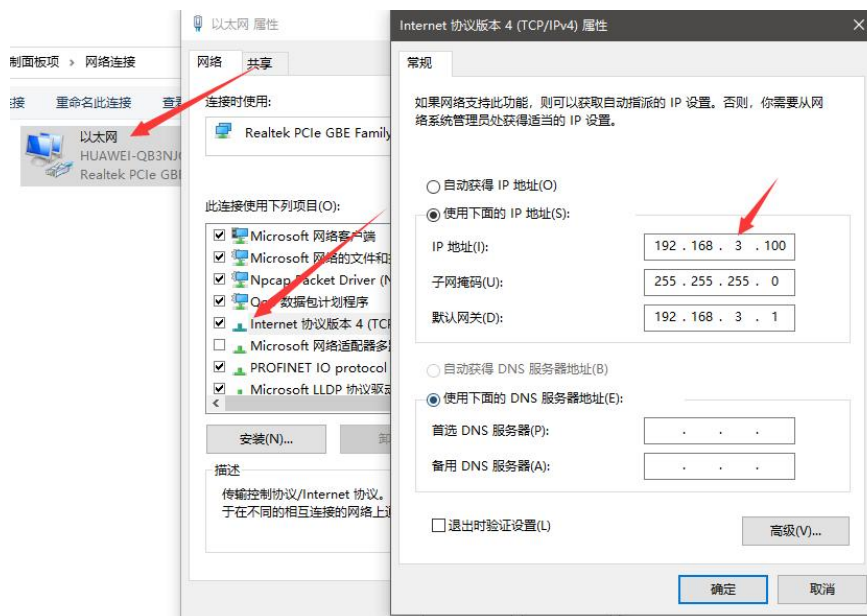

Step 2: Open the network assistant, select the TCP client, enter the remote host IP 192.168.3.7 (default parameter), enter the port number 502 (default parameter), and select HEX to send.

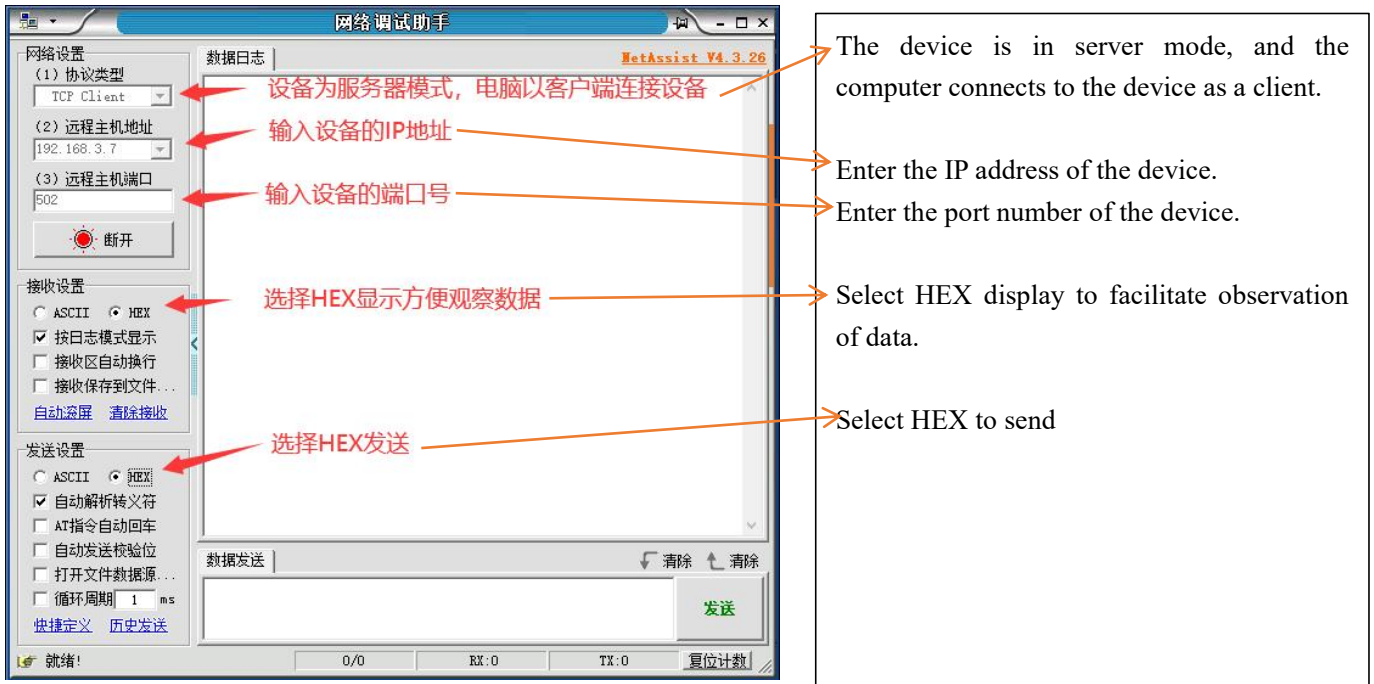

2.4 Control Testing

2.4.1 Modbus TCP control

Use the network assistant to control the first DO output of ME31-XXAX0060.

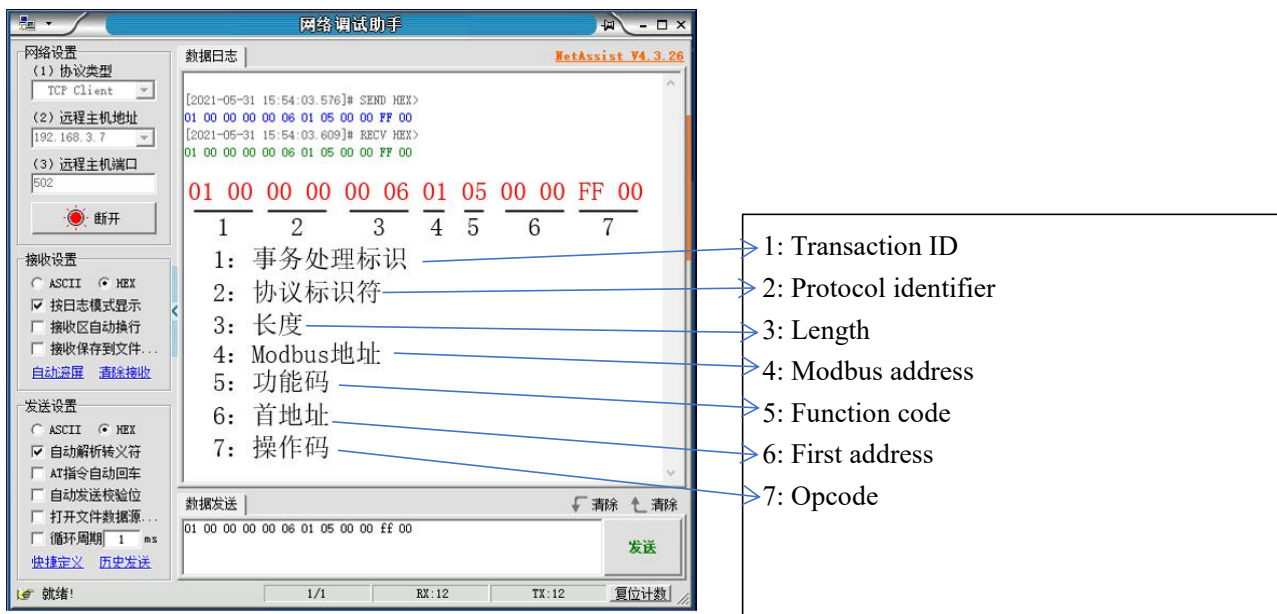

Other functions can be tested through the commands in the table below.

Function (function code)	Command
Pull in the first coil (0x05)	01 00 00 00 00 06 01 05 00 00 FF 00
Full open command (0x0F)	02 00 00 00 00 08 01 0F 00 00 00 06 01 3F
Full close command (0x0F)	02 00 00 00 00 08 01 0F 00 00 00 06 01 00
Read all DO status (0x01)	01 00 00 00 00 06 01 01 00 00 00 06

2.4.2 Modbus RTU control

Use the serial port assistant to control the first DO output of ME31-XXAX0060.

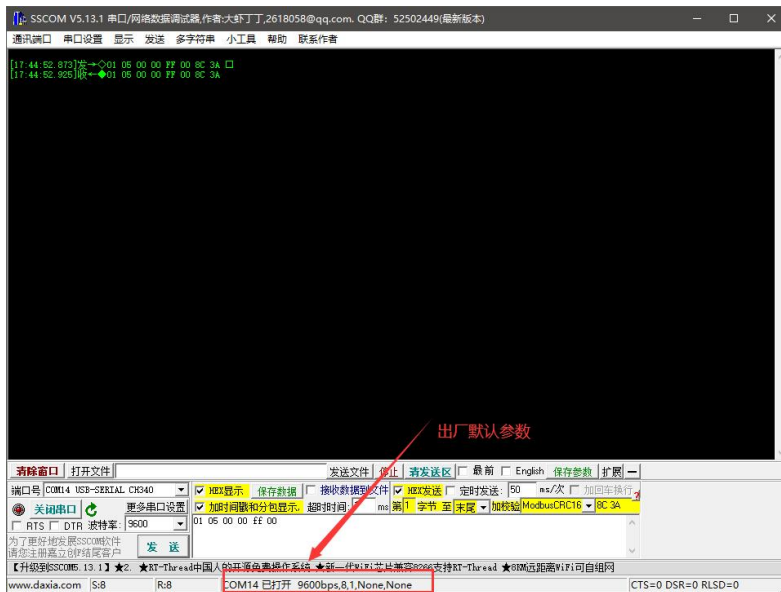

Other functions can be tested through the commands in the table below.

Function (function code)	Command
Pull in the first coil (0x05)	01 05 00 00 FF 00 8C 3A
Full open command (0x0F)	01 0F 00 00 00 06 01 3F DF 46
Full close command (0x0F)	01 0F 00 00 00 06 01 00 9F 56
Read all DO status (0x01)	01 01 00 00 00 06 BC 08

III. Technical Specification

3.1 Specifications

Category	Name	Parameters
Power supply	Operating Voltage	DC8 ~ 28V
	Power indicator	Blue LED indication
Serial port	Communication Interface	RJ45、RS485
	Baud rate	9600bps (customizable)
	Protocol	Standard Modbus TCP, Modbus RTU protocol
MODBUS	Device address	Can be modified by Modbus command and host computer
DO output	Number of DO channels	6 way
	DO output type	Form A relay
	DO output mode	Level output, pulse output
	Relay contact capacity	30V/5A, 250V/5A
	Output indication	OLED screen display, red LED indication
Other	Product Size	121mm * 72mm * 34mm (L*W*H)
	Product weight	150 ±5 g
	Working temperature and humidity	-40 ~ +85°C, 5% ~ 95%RH (no condensation)
	Storage temperature and humidity	-40 ~ +105°C, 5% ~ 95%RH (no condensation)
	Installation method	Din-rail installation

3.2 Device Default Parameters

Category	Name	Parameters
Ethernet parameters	Operating mode	TCP server (up to 4-way client access)
	Local IP	192.168.3.7
	Local port	502
	Subnet mask	255.255.255.0

	Gateway address	192.168.3.1
	DHCP	Close
	Native MAC	Determined by the chip (fixed)
	Target IP	192.168.3.3
	Target port	502
	DNS server	114.114.114.114
	Active upload	Close
Serial parameters	Baud rate	9600bps (8 types)
	Check method	None (default), Odd, Even
	Data bit	8
	Stop bit	1
MODBUS parameter	Modbus master-slave	Slave
	Address	1

3.3 Mechanical Dimensional Drawing

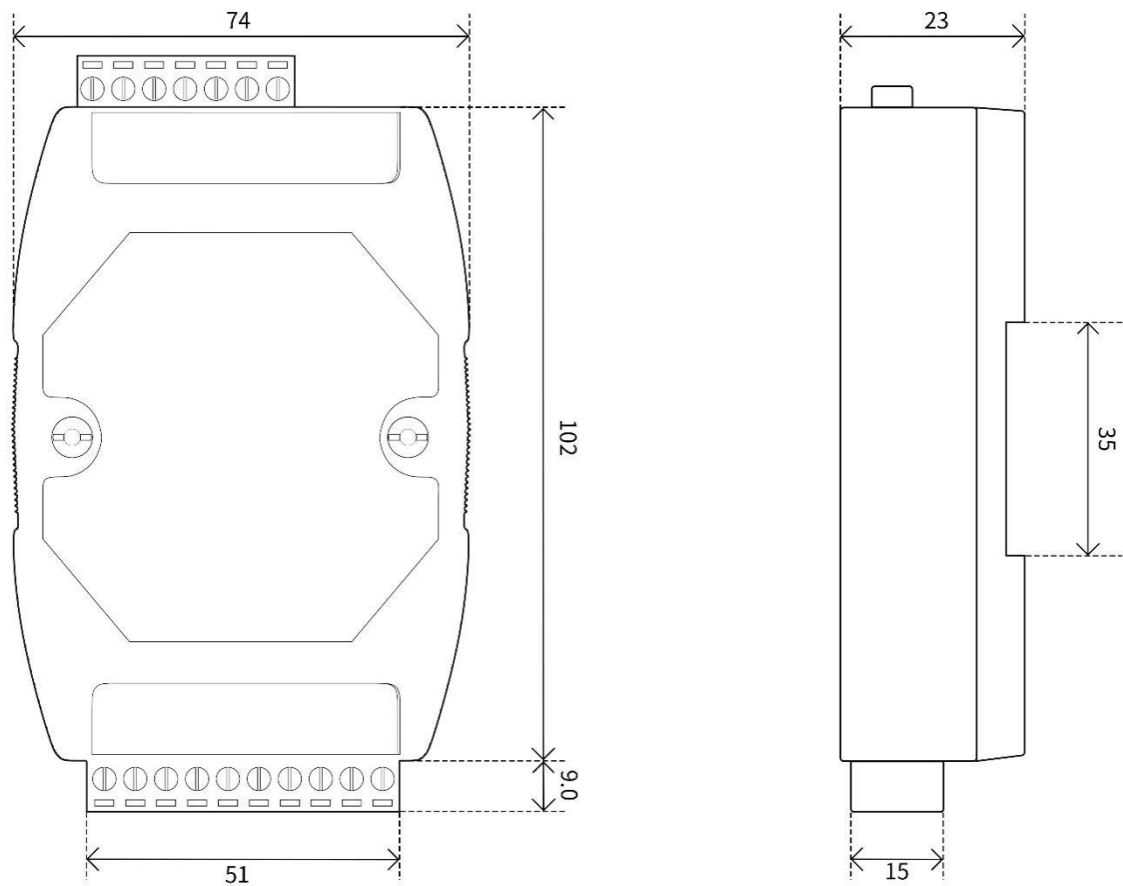

3.4 Port and indicator light description



No.	Label	Illustrate
1	TX (LED)	Serial port send data indicator light
2	RX (LED)	Serial port receiving data indicator light
3	LINK (LED)	Network connection light
4	NET (LED)	Network data sending and receiving indicator light
5	PWR (LED)	Power input indicator
6	DO1 (LED)	The first relay output indicator
7	DO2 (LED)	The second relay output indicator
8	DO3 (LED)	The third relay output indicator
9	DO4 (LED)	The fourth relay output indicator
10	DO5 (LED)	Fifth relay output indicator
11	DO6 (LED)	Sixth relay output indicator
12	GND	Negative pole of power input terminal, DC 8V~28V, 5.08mm Phoenix terminal.
13	VCC	Positive pole of power input terminal, DC 8V~28V, 5.08mm Phoenix terminal.
14	NO1	Relay 1 normally open pin, used with relay 1 common terminal, 5.08mm Phoenix terminal.
15	COM1	Common terminal of relay 1, used in conjunction with the normally open pin of

		relay 1, 5.08mm Phoenix terminal.
16	NO2	Relay 2 normally open pin, used with relay 2 common terminal, 5.08mm Phoenix terminal.
17	COM2	Common terminal of relay 2, used in conjunction with the normally open pin of relay 2, 5.08mm Phoenix terminal.
18	NO3	Relay 3 normally open pin, used with relay 3 common terminal, 5.08mm Phoenix terminal.
19	COM3	Common terminal of relay 3, used in conjunction with the normally open pin of relay 3, 5.08mm Phoenix terminal.
20	NO4	Relay 4 normally open pin, used with relay 4 common terminal, 5.08mm Phoenix terminal.
21	COM4	Relay 4 common terminal, used with relay 4 normally open pin, 5.08mm Phoenix terminal.
22	Ethernet	Ethernet interface, standard RJ45 interface.
23	COM6	Common terminal of relay 6, used in conjunction with the normally open pin of relay 6, 5.08mm Phoenix terminal.
24	NO6	Relay 6 normally open pin, used with relay 6 common terminal, 5.08mm Phoenix terminal.
25	COM5	Common terminal of relay 5, used in conjunction with the normally open pin of relay 5, 5.08mm Phoenix terminal.
26	NO5	Relay 5 normally open pin, used with relay 5 common terminal, 5.08mm Phoenix terminal.
27	GND	Signal ground, 5.08mm Phoenix terminal.
28	485-A	The A of the serial port is connected to the A interface of the external device, and the 5.08mm Phoenix terminal.
29	485-B	The B of the serial port is connected to the B interface of the external device, and the 5.08mm Phoenix terminal.

IV. Product Function Introduction

4.1 DO output

Relay output mode: output different mode output according to the mode set by the user, and the level output is turned on by default.

4.1.1. Input count

Support counting DI input, users can configure rising edge acquisition, falling edge acquisition, and level acquisition according to their own needs. You can also change the clearing method according to your needs.

Trigger method:

Rising edge: When the rising edge is collected (it is not counted when it is turned on, it is counted when it is turned off), it will be counted once.

Falling edge: When the falling edge is collected (counting when it is turned on, and not counting when it is released), count once.

Level: Two edges are collected and counted once respectively.

Clearing method:

Automatic: The device will automatically clear each time the DI count value register (0x09DF~0x09E6) is read.

Manual: In manual mode, it is necessary to write 1 to the clear signal register (0x0AA7~0x0AAE), and each holding register controls one clear signal.

4.1.2. Level output

Output according to the level set by the user, the switch characteristic of the level mode is similar to the function of a self-locking switch.

4.1.3. Pulse output

After the switch output DO is turned on, the switch output DO is automatically turned off after maintaining the set pulse width time (in ms). The pulse width setting range is 50~65535ms (50ms by default).

4.1.4. Follow mode

According to the follow source configured by the user (when the device has AI acquisition or DI detection function, both DI or AI can be used as the follow source, otherwise this function is useless) to change the relay state, and multiple outputs can follow the same follow source output. To put it simply, DI detects the input, and automatically outputs a relay that uses it as a follow source (for example: DI is 1, DO is closed). When the follow

mode is turned on, the follow source should be configured at the same time, otherwise it will follow the first input by default.

4.1.5. Reverse follow mode

According to the follow source configured by the user (when the device has AI acquisition or DI detection function, both DI or AI can be used as the follow source, otherwise this function is useless) to change the relay state, and multiple outputs can follow the same follow source output. To put it simply, DI detects the input, and automatically outputs the relay that follows it as the source (for example: DI is 1, DO is disconnected). When the follow mode is turned on, the follow source should be configured at the same time, otherwise it will follow the first input by default.

4.1.6. Trigger toggle mode

According to the follow source configured by the user (when the device has AI acquisition or DI detection function, both DI or AI can be used as the follow source, otherwise this function is useless) to change the relay state, and multiple outputs can follow the same follow source output. Simply put, when DI generates a trigger signal (rising edge or falling edge), DO will have a state change. When the trigger flip mode is turned on, the following source should be configured at the same time, otherwise it will follow the first input by default.

4.1.7. Power-on state

According to the state set by the user. After the device is powered on, the output relay is turned on according to the state set by the user, and it is turned off by default.

4.2 Modbus Gateway

The device can transparently transmit non-native Modbus commands from the network/serial port to the serial port/network, and the local Modbus commands are directly executed.

4.2.1. Modbus TCP/RTU protocol conversion

After it is turned on, the Modbus TCP data on the network side will be converted to Modbus RTU data.

4.2.2. Modbus Address Filtering

This function can be used when some host software or configuration screen is used as the host to access the serial port of the device, and the gateway function of the device is used, the slave is at the network end, and the Modbus TCP to RTU function is turned on. Multiple slaves on the bus may cause data confusion. At this time, enabling address filtering can ensure that only the specified address can pass through the device; when the parameter is 0, the data will be transparently transmitted; when the parameter is 1-255, only the set slave machine

address data.

4.2.3. Modbus TCP Protocol Data Frame Description

TCP frame format:

Transaction ID	Protocol ID	Length	Device address	Function code	Data segment
2 Bit	2 Bit	N+2 Bit	1 Bit	1 Bit	N Bit

- Transaction ID: It can be understood as the serial number of the message. Generally, 1 is added after each communication to distinguish different communication data messages.
- Protocol identifier: 00 00 means Modbus TCP protocol.
- Length: Indicates the length of the next data in bytes.

Example: get DI status

01 00	00 00	00 06	01	02	00 00 00 04
Transaction ID	Protocol ID	Length	Device address	Function code	Data segment

4.2.4. Modbus RTU protocol data frame description

RTU frame format:

Device address	Function code	Data segment	Check codeCRC
1 Bit	1 Bit	N Bit	2 Bit

Example: get DI status command

01	02	00 00 00 04	79 C9
Device Modbus address	Function code	Data segment	CRC check code

4.3 Active upload

The device supports the function of uploading analog input values at regular intervals. Setting the value of the corresponding register can control the interval time and whether to upload.

Devices with digital input will actively upload once after successfully connecting to the server, and then the digital input will be uploaded following the status change. Devices with analog input will report the status of analog input according to the configured active upload time period (the configuration period is 1-65535).

When it is set to 0, the upload is disabled; if it is set to other positive integer value N, the upload will be performed at intervals of N seconds.

[Note] The device can only be valid if it is configured in client mode, and the register value is non-zero to enable active upload.

4.4 Custom Module Information

4.4.1. Modbus Address

The device address is 1 by default, and the address can be modified, and the address range is 1-247.

4.4.2. Module Name

Users can configure the device name according to their own needs to distinguish, support English, digital format, up to 20 bytes.

4.4.3. Network parameters

Unless otherwise specified: the following network-related parameters default to IPV4-related parameters.

- (1) MAC of the device: the user can obtain it by reading the specified register, and this parameter cannot be written.
- (2) IP address: device IP address, readable and writable.
- (3) Modbus TCP port: the port number of the device, readable and writable.
- (4) Subnet mask: address mask, readable and writable.
- (5) Gateway address: gateway.
- (6) DHCP: Set the way the device obtains IP: static (0), dynamic (1).
- (7) Target IP: When the device works in client mode, the target IP or domain name of the device connection.
- (8) Destination port: When the device is working in client mode, the destination port of the device connection.
- (9) DNS server: The device is in the client mode and resolves the domain name of the server.
- (10) Module working mode: switch the working mode of the module. Server: The device is equivalent to a server, waiting for the user's client to connect. The maximum number of connections is 4. Client: The device actively connects to the target IP and port set by the user.
- (11) Active upload: When this parameter is not 0, and the device is in the client mode, the discrete input status of the device will be uploaded to the server when it is connected for the first time or the input changes, and the analog input will be uploaded according to the configured time period.

4.4.4. Serial Port Parameters

Parameters for setting serial communication:

Default parameters:

Baud rate: 9600 (03);

Data bit: 8bit;

Stop bit: 1bit;

Check digit: NONE(00);

(1) Baud rate:

Baud rate code value table	
0x0000	1200
0x0001	2400
0x0002	4800
0x0003 (default)	9600
0x0004	19200
0x0005	38400
0x0006	57600
0x0007	115200

(2) Check Digit:

Check Digit	
0x0000(default)	NONE
0x0001	ODD
0x0002	EVEN

4.5 OLED display and parameter configuration

The display interface includes an information display page (DO status display page) and a parameter setting page (partial parameters).

4.5.1. Information Display Interface

Including the DO status display page, short press the up and down buttons to switch the interface.

4.5.2. Equipment parameter display interface

Press the left or right button to enter the password input interface, complete the correct password input, and display the device parameter information interface (password interface: default password: 0000. Short press the middle to verify the password; The left and right buttons can switch the password bit; Up and down keys can switch the value of the current bit. The password has a total of 4 digits, and each input is a number ranging from 0-9):

The parameter setting interface from top to bottom is:

1. Modbus address;
2. Baud rate;
3. Data bits;
4. Check Digit;
5. Stop bit;

6. Local port;
7. Local IP address;
8. Network mode;
9. Gateway;
10. Subnet mask;
11. DNS;
12. MAC address;
13. DHCP;
14. Target IP;
15. Destination port;
16. Modbus TCP/RTU protocol conversion;
17. Active upload;
18. Modbus address filtering;;

4.5.3. Equipment Parameter Configuration Interface

Press and hold the confirmation button to enter the password input interface, complete the correct password input, and enter the configuration interface (password interface: default password: 0000; short press the middle to verify the password, the left and right buttons switch the password bit, and the up and down buttons switch the value of the current bit , the password has a total of 4 digits, and each input range is a number from 0-9).

Select the setting item, enter the parameter configuration page and short press the up and down keys to switch the setting item;

Select the setting item, short press to confirm or right click, the setting item gets the cursor to represent the selection and enter the setting item;

Adjust the parameter value: After selecting the setting item, the up and down keys can change the value or optional value; the left and right keys move the cursor in the parameter item;

Confirm the parameter value: After adjusting the parameter value, press the enter key to exit the current setting item.

Save parameter settings and restart: After setting the parameters, move the cursor to save and restart, then short press the confirmation key to enter the confirmation save and restart state. Short press the confirmation key (press other keys to exit the confirmation state) to save the parameters and restart the device.

Exit without saving parameters: move the cursor to exit, then short press the confirmation key to enter the confirmation exit state, short press the confirmation key (press other keys to exit the confirmation state), and then exit the parameter configuration interface without saving the parameters .

Among them, the data bit and stop bit cannot be set. After the DHCP mode is turned on, the local IP address, gateway, and subnet mask cannot be configured and are only assigned by the router;

4.5.4. Screen Sleep

The device screen has a sleep function, which is off by default and can be set to on in the configuration interface.

In any interface, when there is no button operation for 180 seconds, the screen will enter the sleep mode. At this time, the interface displays Ebyte robot. Press any button can exit the sleep mode.

When the screen is in sleep mode, the running efficiency of device programs will be improved.

4.6 MODBUS parameter configuration

4.6.1. DO Register List

Register function	Register address	Register type	Number	Operate	Data Range/Remarks	Related function code
DO status	0x0000	Coil	6	RW	Write to change the current DO state, read to obtain the current DO state	R: 0x01 W: 0x0F、0x05
State when DO is powered on	0x0064	Holding register	6	RW	The default state of the coil after power on	R: 0x01 W: 0x0F、0x05
DO working mode	0x0578	Holding register	6	RW	0x0000 level no follow mode 0x0001 Pulse no follow mode 0x0002 Follow mode 0x0003 Reverse Follow Mode 0x0004 Trigger Flip Mode	R: 0x03 W: 0x06、0x10
DO pulse width	0x05DC	Holding register	6	RW	Range: 50-65535ms	R: 0x03 W: 0x06、0x10
DO Follow Source	DI:0x0000 AI:0x8000	Holding register	6	RW	Scope: 0x0000: Follow DI1 0x0001: Follow DI2 0x8000: Follow AI1 0x8001: Follow AI2	R: 0x03 W: 0x06、0x10

4.6.2. Module related registers

Register function	Register address	Register type	Number	Operate	Data Range/Remarks	Related function code
Module address	0x07E8	Holding register	1	RW	Modbus address, 1 ~ 247 configurable addresses	R: 0x03 W: 0x06
Module model	0x07D0	Holding register	12	R	Get the current model	R: 0x03
Firmware version	0x07DC	Holding register	1	R	Get firmware version number	R: 0x03
Module name	0x07DE	Holding register	10	RW	Custom module name	R: 0x03 W: 0x10
Module restart	0x07EA	Holding register	1	W	Write any value to restart	W: 0x06
Restore factory parameters	0x07E9	Holding register	1	W	Write random value to restore factory parameters	W: 0x06
Serial baud rate	0x0834	Holding register	1	RW	See baud rate code table, Default is 9600 (0x0003)	R: 0x03 W: 0x06、0x10
Serial check digit	0x0836	Holding register	1	RW	0x0000 no checksum (default) 0x0001 odd parity 0x0002 even parity	R: 0x03 W: 0x06、0x10

4.6.3. Network related registers

Register function	Register address	Register type	Number	Operate	Data Range/Remarks	Related function code
Module MAC address	0x0898	Holding register	3	R	Device MAC parameters	R: 0x03
Local IP address	0x089B	Holding register	2	RW	Default: 192.168.3.7	R: 0x03 W: 0x06、0x10
local port	0x089D	Holding register	1	RW	1~65535, default: 502	R: 0x03 W: 0x06、0x10
Subnet mask address	0x089E	Holding register	2	RW	Default: 255.255.255.0	R: 0x03 W: 0x06、0x10
Gateway address	0x08A0	Holding register	2	RW	Default: 192.168.3.1	R: 0x03 W: 0x06、0x10
DHCP mode	0x08A2	Holding	1	RW	0x0000 static IP	R: 0x03

setting		register			(default) 0x0001 Obtain IP automatically	W: 0x06、0x10
Target IP/domain name	0x08A3	Holding register	64	RW	String format stored in IP/domain name Default IP: 192.168.3.3	R: 0x03 W: 0x06、0x10
Server port	0x08E3	Holding register	1	RW	0-65535, default 502	R: 0x03 W: 0x06、0x10
DNS server IP address	0x08E4	Holding register	2	RW	Default 8.8.8.8	R: 0x03 W: 0x06、0x10
Module work mode	0x08E6	Holding register	1	RW	0x0000 server mode 0x0001 client mode	R: 0x03 W: 0x06、0x10
Active upload	0x08E7	Holding register	1	RW	0x0000 disabled, others: 1 ~ 65535s cycle sending	R: 0x03 W: 0x06、0x10
MOSBUS TCP/RTU conversion enable	0x08E8	Holding register	1	RW	0, close, 1 open protocol conversion	R: 0x03 W: 0x06、0x10
MODBUS address filtering	0x08E9	Holding register	1	RW	0: transparent transmission, 1-255: when the data is not local, check the slave address of the command , and it can be passed when it is the set value	R: 0x03 W: 0x06、0x10

4.6.4. Examples of Modbus command operation instructions

1. Read coil (DO) status

Use the read coil state (01) function code to read the output coil state, for example:

01	01	00 00	00 04	3D C9
Modbus address	Function code	Register first address	Number of output coils read	CRC check code

After sending the above command to the device through the 485 bus, the device will return the following values:

01	01	01	01	90 48
Modbus address	Function code	Bytes of data	Returned status data	CRC check code

The status data 01 returned above indicates that the output DO1 is turned on.

2. Control coil (DO) state

Support operation of single coil (05), operation of multiple coils (0F) function code operation.

Use the 05 command to write a single command, for example:

01	05	00 00	FF 00	8C 3A
Modbus address	Function code	Register first address	Continuity: FF 00 Close: 00 00	CRC check code

After sending the above command to the device through the 485 bus, the device will return the following values:

01	05	00 00	FF 00	8C 3A
Modbus address	Function code	Register first address	Operation method	CRC check code

The DO1 coil is turned on.

Use 0F function code as the command to write multiple coils, for example:

01	0F	00 00	00 04	01	0F	7E 92
Modbus address	Function code	Initial address	Number of coils	Bytes of data	Control coil data	CRC check code

After sending the above command to the device through the 485 bus, the device will return the following values:

01	0F	00 00	00 04	54 08
Modbus address	Function code	Register address	Number of coils	CRC check code

The coils are all on.

3. Read the holding register

Use 03 function code to read one or more register values, for example:

01	03	05 78	00 01	04 DF
Modbus address	Function code	Register first address	Number of registers read	CRC check code

After sending the above command to the device through the 485 bus, the device will return the following values:

01	03	02	00 00	B8 44
Modbus address	Function code	Bytes of data	Returned data	CRC check code

The above 00 00 means that DO1 is in level output mode.

4. Operation holding register

Support operation of single register (06), operation of multiple registers (10) function code operation.

Use 06 function code to write a single holding register, for example: set the working mode of DO1 to pulse mode:

01	06	05 78	00 01	C8 DF
Modbus address	Function code	Register address	Write value	CRC check code

After sending the above command to the device through the 485 bus, the device will return the following values:

01	06	05 78	00 01	C8 DF
Modbus address	Function code	Register address	Write value	CRC check code

If the modification is successful, the data in the 0x0578 register is 0x0001, and the pulse output mode is turned on.

Use function code 10 to write multiple holding register commands, for example: set the working mode of DO1 and DO2 at the same time.

01	10	05 78	00 02	04	00 01 00 01	5A 7D
Modbus address	Function code	Register head address	Number of registers	Number of bytes of written data	Written data	CRC check code

After sending the above command to the device through the 485 bus, the device will return the following values:

01	10	05 78	00 02	C1 1D
Modbus address	Function code	Register address	Number of registers	CRC check code

If the modification is successful, the values of the two consecutive registers starting with 0x0578 are 0x0001 and 0x0001 respectively, marking DO1 and DO2 to enable pulse output.

V. Configuration Software

5.1. Acquisition and Control

Step 1: Connect the device to the configuration software.

(1) You can configure the device by selecting the interface (serial port/network port); if you choose the network port, you must first select the network card and then search for the device.

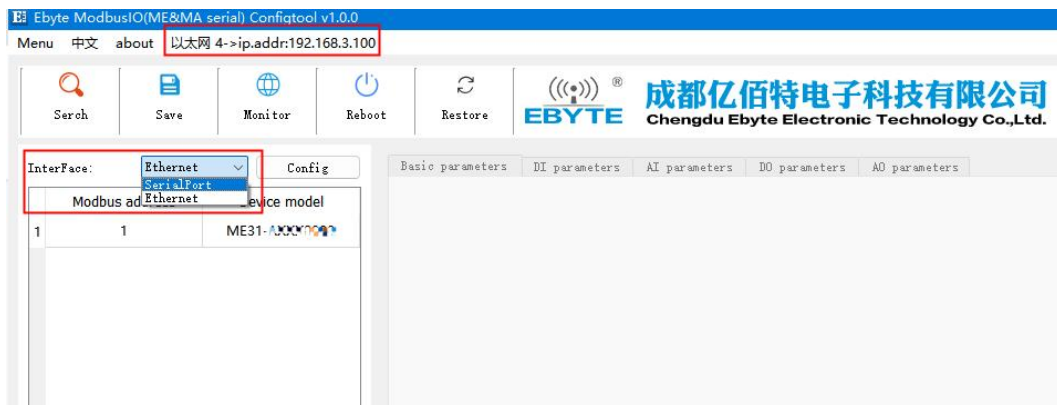

(2) If you choose a serial port, you need to select the corresponding serial port number, and the same baud rate, data bit, stop bit, parity bit and address segment search range as the device, and then search.

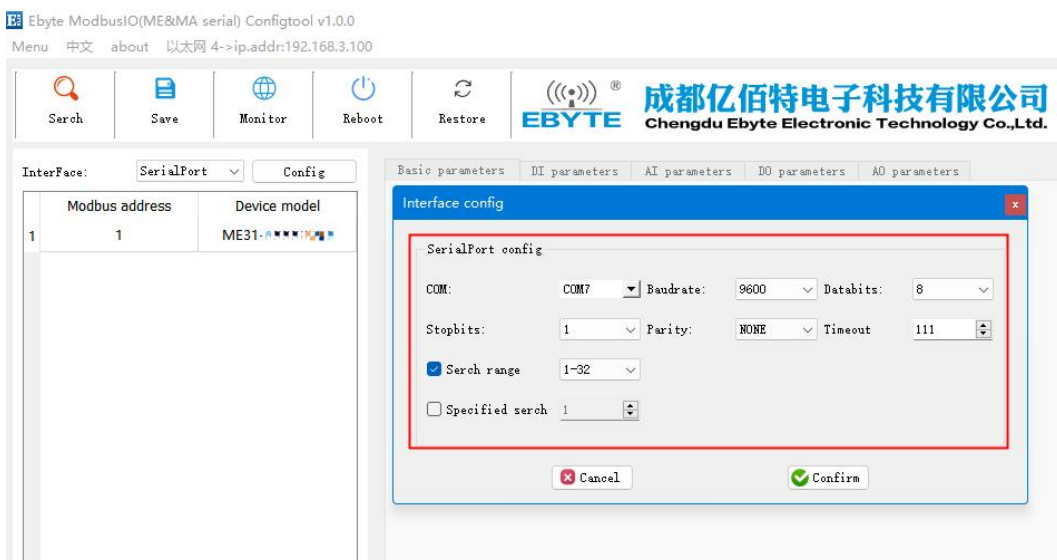

Step 2: Select the corresponding device.

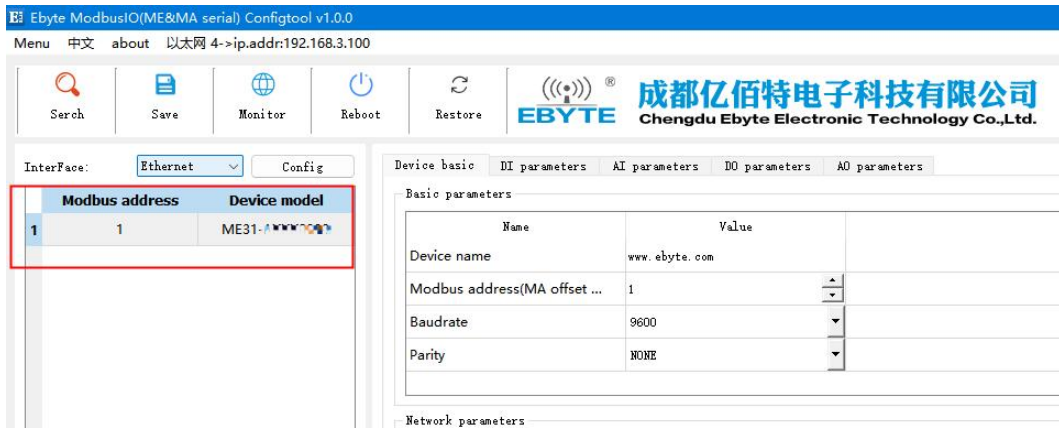

Step 3: Click the device online to enter the IO monitoring. The following is the IO monitoring screen display.

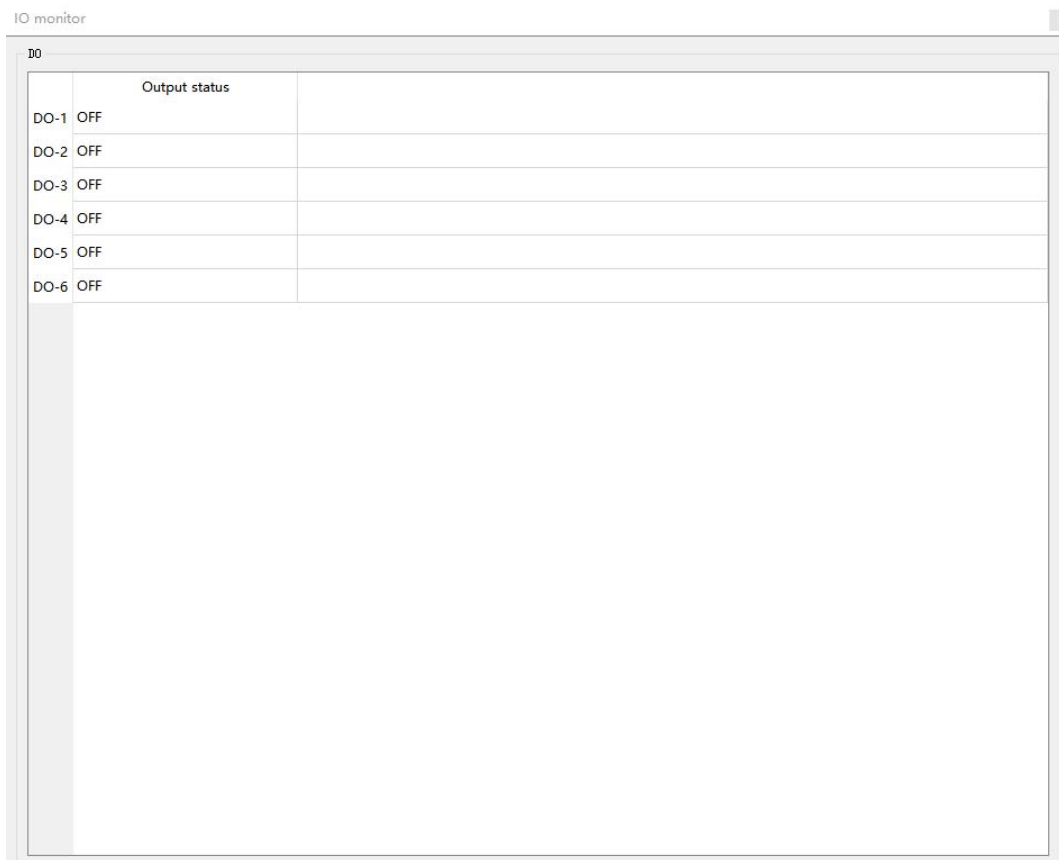

5.2. Parameter configuration interface

Step 1: Connect the device refer to "Acquisition and Control".

Step 2: You can configure device parameters, network parameters, DI parameters, AI parameters, DO parameters, and AO parameters (for example: if the device has no AO function, the AO parameters cannot be configured)

Log

Date	Time	Info
2023-07-12	13:51:20.032	Searching
2023-07-12	13:51:20.086	Search for all device.....
2023-07-12	13:51:21.028	Uploading parameters->MAC address:38-3B-26-22-A3-A4
2023-07-12	13:51:21.812	uploading parameters success->Modbus address:1,device model:ME31-XXXXXX
2023-07-12	13:51:21.813	The search is complete->A total of1devices were found

Step 3: After configuring the parameters, click Download Parameters. After the prompt message in the log output shows that the parameters are saved successfully, click Restart the device. After the device restarts, the modified parameters will take effect.

Log

Date	Time	Info
2023-07-12	13:51:21.813	The search is complete->A total of1devices were found
2023-07-12	13:52:41.052	Saving parameters
2023-07-12	13:52:41.629	Parameters save success
2023-07-12	13:52:48.714	Rebooting
2023-07-12	13:52:48.742	Reboot Success

Revise history

Version	Revision date	Revision Notes	Maintenance man
1.0	2023-6-6	Initial version	LT

About us

Technical support: support@cdebyte.com

Documents and RF Setting download link: <http://www.cdebyte.com>

Tel: +86-28-61399028

Fax: 028-64146160

Web: <http://www.cdebyte.com>

Address: Innovation Center D347, 4# XI-XIN Road, Chengdu, Sichuan, China