



E31-230T33D User Manual

AX5243 230MHz 2W DIP Wireless Module



Contents

1. OVERVIEW	3
1.1 INTRODUCTION	3
1.2 FEATURES	3
1.3 APPLICATION SCENARIOS	3
2. SPECIFICATIONS	4
2.1 LIMIT PARAMETERS	4
2.2 WORKING PARAMETERS	4
3. SIZE AND PIN DEFINITION	5
4. CONNECT TO MCU	6
5 FUNCTION DESCRIPTION	6
5.1 FIXED TRANSMISSION	6
5.2 BROADCASTING TRANSMISSION	7
5.3 BROADCASTING ADDRESS	7
5.4 MONITOR ADDRESS	7
5.5 RESET	7
5.6 AUX DESCRIPTION	7
5.6.1 Indication of UART output	8
5.6.2 Indication of wireless transmitting	8
5.6.3 Configuration procedure of module	8
5.6.4 Notes for AUX	9
6 OPERATING MODE	9
6.1 MODE SWITCHING	9
6.2 NORMAL MODE (MODE 0)	10
6.3 WOR MODE (MODE 1)	10
6.4 POWER SAVING MODE (MODE 2)	11
6.5 SLEEP MODE (MODE 3)	11
7 COMMAND FORMAT	11
7.1 FACTORY DEFAULT PARAMETER	11
7.2 WORKING PARAMETER READING	12
7.3 VERSION NUMBER READING	12
7.4 RESET INSTRUCTION	12
7.5 PARAMETER SETTING INSTRUCTION	12
8 HARDWARE DESIGN	14
9 FAQ	15
9.1 TRANSMISSION DISTANCE IS NOT IDEAL	15
9.2MODULE IS EASY TO DAMAGE	15
9.3 BIT ERROR RATE IS TOO HIGH	15

10 WELDING OPERATION GUIDANCE	15
10.1 REFLOW TEMPERATURE	错误! 未定义书签。
10.2 REFLOW PROFILE	错误! 未定义书签。
11 E31 SERIES	16
12 ANTENNA INSTRUCTION	16
12.1 ANTENNA RECOMMENDATION	16
13 BATCH PACKAGING METHOD	17
REVISE HISTORY	18
ABOUT US	18

1. Overview

1.1 Introduction

E31-230T33D is a 230M SMD wireless serial port module (UART) with AXSEM AX5243 RF chip imported from Switzerland, half duplex, transceiver integrated, transparent transmission mode, 225~237.6MHz frequency band (default 230MHz), TTL level output with air wake-up function (ultra-low power consumption).

The module has a FEC forward error correction algorithm, which has high coding efficiency and strong error correction capability. In the case of sudden interference, it can actively correct the interfered data packets, greatly improving reliability and transmission distance. In the absence of FEC, such packets can only be discarded. The module has data encryption and compression function. The data transmitted by the module in the air is random, and the data interception is meaningless through strict encryption and decryption algorithms. The data compression function has the probability of reducing the transmission time, reducing the probability of interference, improving reliability and transmission efficiency.

E31-230T33D strictly abides by FCC, CE, CCC and other domestic and foreign design specifications, meets all RF related certifications, and meets export requirements.

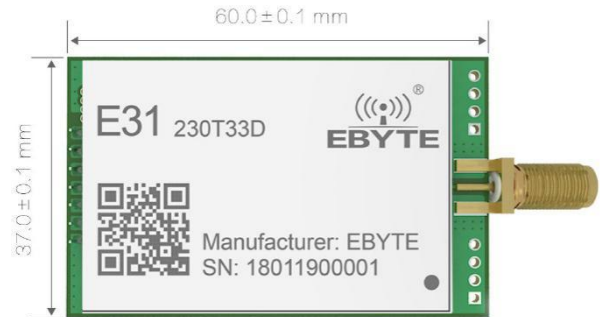

1.2 Features

- The real testing distance reaches 8km;
- The max transmitting power is 2W;
- Support global license-free ISM 230MHz band;
- Support data transmission rate from 1.2kbps to 70kbps;
- Support low power mode, suitable for battery applications;
- Supports 3.3V~5.2V power supply, and more than 3.3V power supply can guarantee the best performance;
- Support advanced ultra-narrow band GFSK modulation.
- Industrial grade standard design, support for long-term use from -40 to 85 °C;
- SMA interface, easy connection of coaxial cable or external antenna.

1.3 Application

- Home security alarm and remote keyless entry;
- smart home and industrial sensors;
- wireless alarm security system;
- Building automation solutions;
- Wireless industrial grade remote control;
- Intelligent agriculture and oilfield solutions;
- health care products;
- Advanced Meter Reading Architecture (AMI);
- Automotive industry applications.

2. Specifications

2.1 Limit parameters

Main parameter	Performance		Remark
	Mini. value	Max. value	
supply voltage (V)	0	5.2	The module will be burnout permanently with over 5.5V
Blocking power (dBm)	-	10	There's small probability of burning module at close range use
Operating temperature (°C)	-40	85	

2.2 Working parameters

Main parameter		Performance			Remark
		Mini.	Typical	Max.	
supply voltage (V)		3.3	5.0	5.2	≥5.0V ensures output power
Communication level (V)			3.3		For 5V TTL, it may be at risk of burning down
Operating temperature (°C)		-40	-	85	Industrial design
Working frequency (MHz)		225	-	237.6	Support ISM band
Power consumption	Transmit current(mA)		1030		Instant power consumption
	Receive current (mA)		15		
	Sleep current (μA)		5		Software is shut down
Max. transmit power (dBm)		33.0	33.0	33.5	
Receiving sensitivity (dBm)		-125	-126	-127	Air data rate is 1.2kbps
Air data rate (bps)		1.2k	5k	70k	Controlled via user's programming

Main parameter	Description	Remark
Distance for reference	8000m	Test condition: clear and open area, antenna gain: 5dBi, antenna height: 2.5m, air data rate: 1.2kbps
subcontracting method	43 Byte	The max capacity for each packet
Buffer	512 Byte	
Modulation	GFSK	
Communication interface	TTL	@3.3V
Package	DIP	
Connector	2.54mm	
Size	37*60mm	
Antenna	SMA-K	50 ohm impedance

3. Size and pin definition

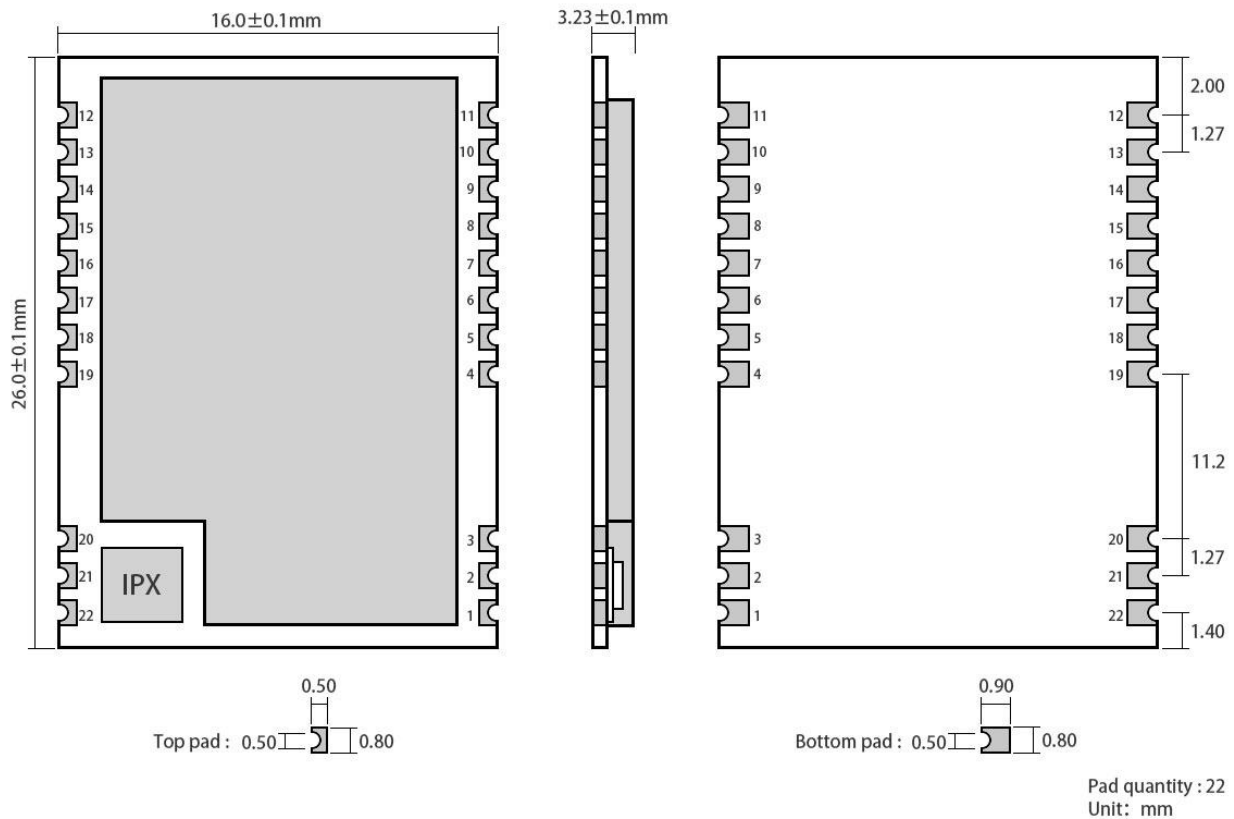

No.	Name	Direction	Function
1	M0	Input (Weak pull-up)	Work with M1 to decide 4 working modes of module (not suspended, if not used, could be grounded).
2	M1	Input (weak pull-up)	Work with M0 to decide 4 working modes of module (not suspended, if not used, could be grounded).
3	RXD	Input	TTL UART inputs, connects to external (MCU, PC) TXD output pin. Can be configured as open-drain or pull-up input.
4	TXD	Output	TTL UART outputs, connects to external RXD (MCU, PC) input pin. Can be configured as open-drain or push-pull output
5	AUX	Output	To indicate module 's working status & wakes up the external MCU. During the procedure of self-check initialization, the pin outputs low level. Can be configured as push-pull output (suspending is allowed).
6	VCC	Input	Power supply : 2.8~ 5.5V DC
7	GND	Input	Ground
8/9	Fixed orifice		Fixed orifice
10/11	Fixed orifice		Fixed orifice
12/13	Fixed orifice		Fixed orifice
14/15	Fixed orifice		Fixed orifice

4. Connect to MCU

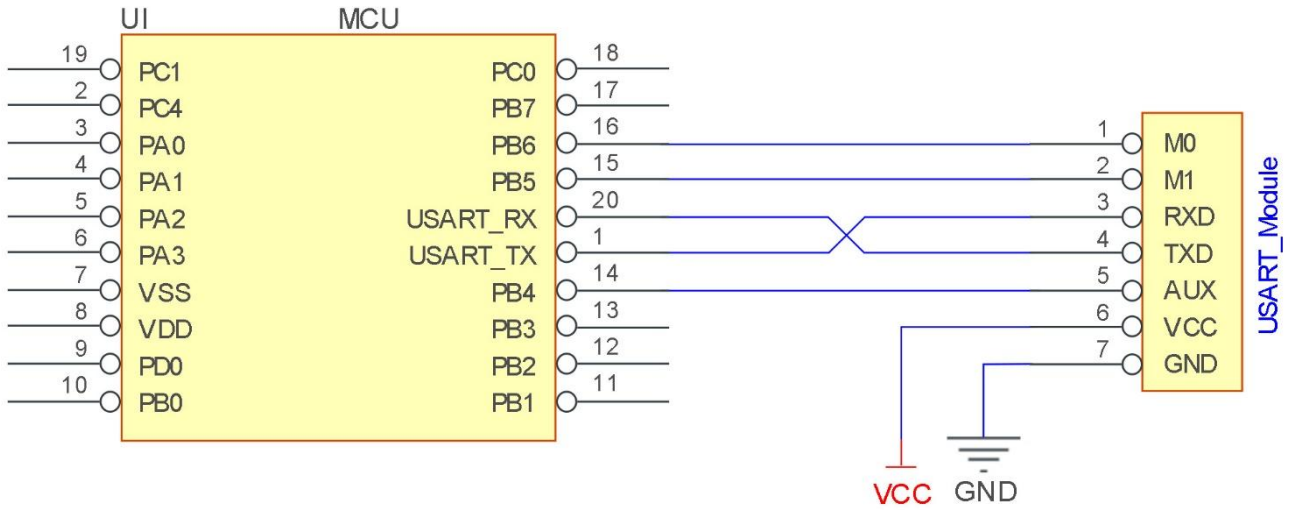

No.	Description (STM8L MCU)
1	The UART module is TTL level, pls connect to the MCU of TTL..
2	For some MCU works at 5VDC, it may need to add 4-10K pull-up resistor for the TXD & AUX pin.

5 Function description

5.1 Fixed transmission

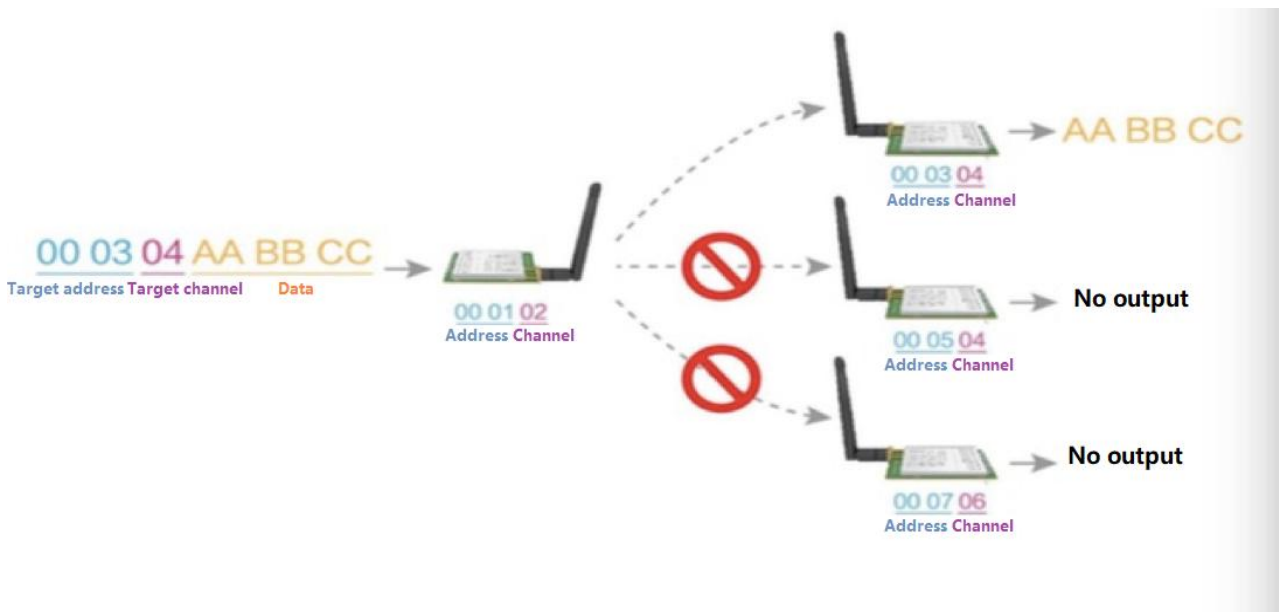

5.2 Broadcasting transmission

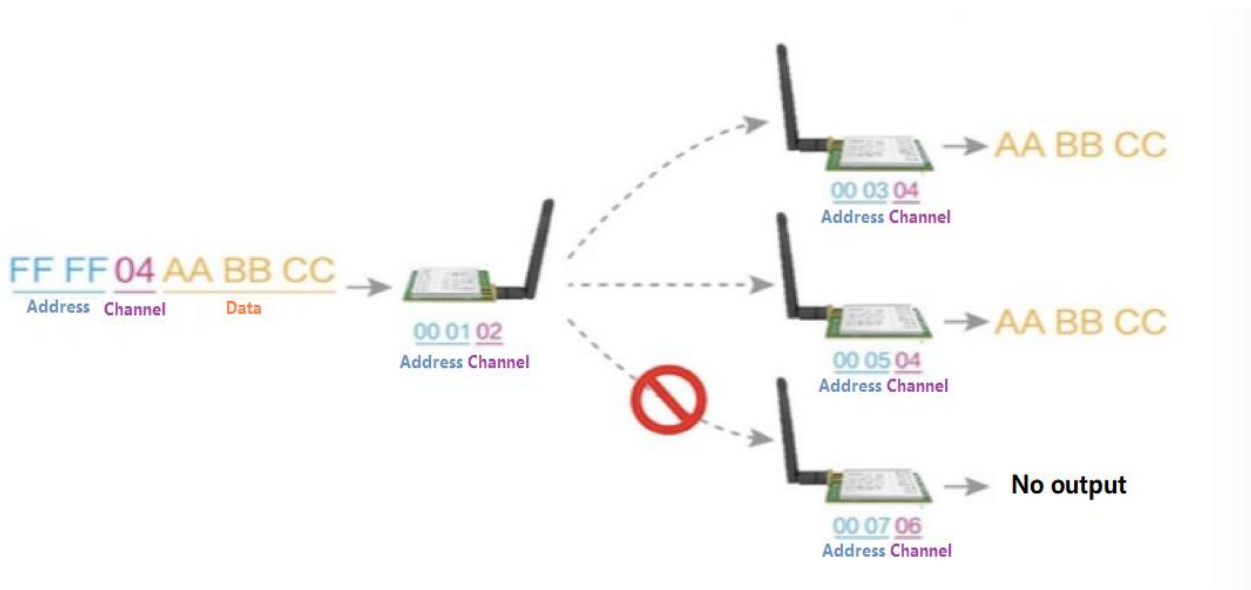

5.3 Broadcasting address

- For example: Set the address of module A as 0xFFFF or 0x0000, and the channel as 0x04;
- When module A works as transmitter(same mode, transparent transmission), all the receivers with 0x04 channel can receive the data, to realize the broadcast transmission.

5.4 Monitor address

- For example: Set the address of module A as 0xFFFF or 0x0000, and the channel as 0x04;
- When module A is the receiver, it can receive the data sent from all modules under channel 0x04, the purpose of monitor is realized.

5.5 Reset

- When the module is powered, AUX outputs low level immediately, conducts hardware self-check and sets the operating mode based on user's parameters. During the process, the AUX remains low level. After the process completed, the AUX outputs high level and starts to work as per the operating mode combined by M1 and M0. Therefore, users need to wait the AUX rising edge as the start of module's normal work.

5.6 AUX description

- AUX Pin can be used as indication for wireless send & receive buffer and self-check.

- It can indicate whether there are data that are not sent yet via wireless way, or whether all wireless data has been sent through UART, or whether the module is still in the process of self-check initialization.

5.6.1 Indication of UART output

- To wake up external MCU

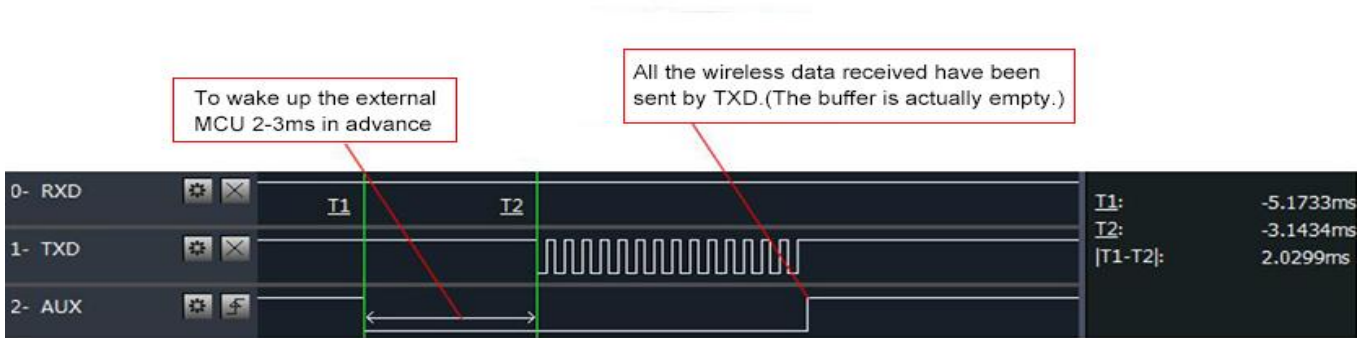

Timing Sequence Diagram of AUX when TXD pin transmits

5.6.2 Indication of wireless transmitting

- Buffer (empty): the internal 512 bytes data in the buffer are written to the RFIC (Auto sub-packaging).
- When AUX=1, the user can input data less than 512 bytes continuously without overflow. Buffer (not empty): when AUX=0, the internal 512 bytes data in the buffer have not been written to the RFIC completely. If the user starts to transmit data at this circumstance, it may cause overtime when the module is waiting for the user data, or transmitting wireless sub package.
- When AUX = 1, it does not mean that all the UART data of the module have been transmitted already, perhaps the last packet of data is still in transmission.

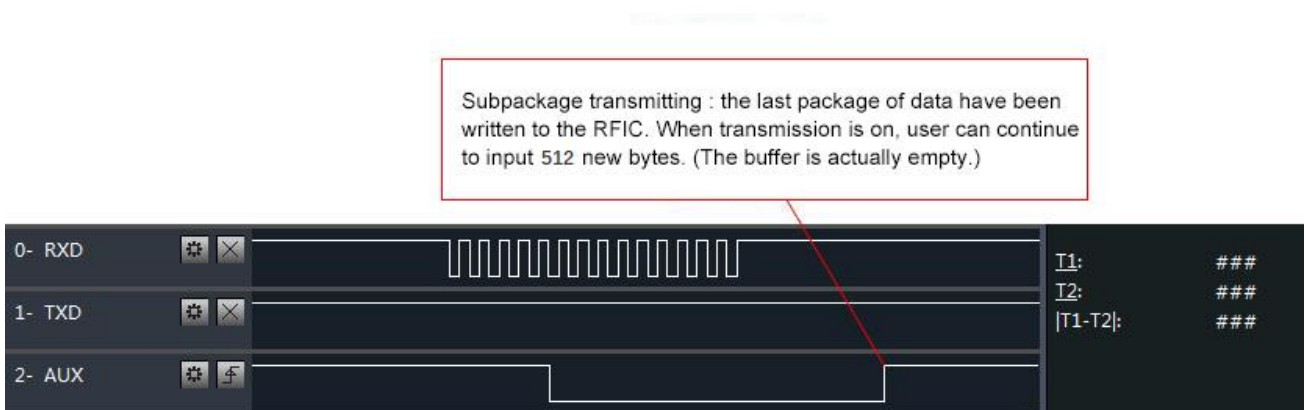

Timing Sequence Diagram of AUX when RXD pin receives

5.6.3 Configuration procedure of module

- Only happened when Reset and exit sleep mode

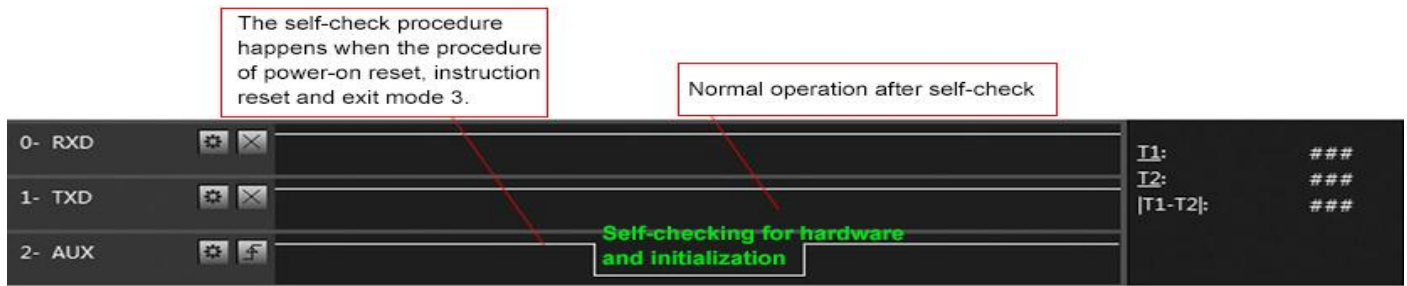

Timing Sequence Diagram of AUX when self-check

5.6.4 Notes for AUX

- For function 1 & function 2 mentioned above, the priority should be given to the one with low level output, which means if it meets each of any low level output condition, AUX outputs low level, if none of the low level condition is met, AUX outputs high level.
- When AUX outputs low level, it means the module is busy & cannot conduct operating mode checking. Within 1ms since AUX outputs high level, the mode switch will be completed.
- After switching to new operating mode, it will not work in the new mode immediately until AUX rising edge lasts for 2ms . If AUX stays on the high level, the operating mode switch can be effected immediately.
- When the user switches to other operating modes from mode 3 (sleep mode) or it's still in reset process, the module will reset user parameters, during which AUX outputs low level.

6 Operating mode

There are four operating modes, which are set by M1 and M0, the details are as follows:

Mode (0-3)	M0	M1	Description	Remark
0 Normal mode	0	0	UART and wireless channel are open, transparent transmission is on	The receiver must be Mode 0、 1
1 WOR mode	1	0	UART and wireless channel are open; The only difference with Mode 0: Before the data packet transmitting, it will add wake-up code automatically, in which the modules under mode 2 can be wake up.	The receiver can be mode0, 1, or 2
2 Power saving mode	0	1	UART receiving is closed, wireless channel is under WOR mode, after the wireless data is received, the wireless channel will be open and send the data out.	The transmitter must be mode 1. In this mode, the transmission is unavailable.
3 Sleep mode	1	1	The module enters sleep mode, but the parameters can be configured.	See more details in working parameters.

6.1 Mode switching

- Users can combine M1 and M0 with high and low levels to determine the operating mode. Two GPIOs of the MCU can be used to control mode switching; After changing M1 and M0: If the module is idle, after 1ms, it can start working according to the new mode; If the serial port data of the module has not been transmitted through the wireless, the new working mode can be switched after the transmission is completed; If the module receives the wireless data and transmits the data through the serial port, it needs to finish transmission before switching the new

working mode; Therefore, mode switching can only be valid when AUX output is 1, otherwise it will delay switching.

- For example, in mode 0 or mode 1, users continuously inputs a large amount of data and simultaneously performs mode switching. At this time, the switching mode operation is invalid; the module will process all the user data before performing the new mode detection; Therefore, the general recommendation is to detect the output state of the AUX pin and switch after 2ms when the output is high.
- When the module is switched from other modes to sleep mode, if the data has not been processed yet; The module will process these data (including receiving and sending) before entering sleep mode. This feature can be used for fast sleep, which saves power; for example, the transmitter module works in mode 0, the user transmits the serial port data "12345", and then does not have to wait for the AUX pin to be idle (high level), and can directly switch to sleep mode. And the user's main MCU immediately sleeps, the module will automatically transmit the user data through the wireless, and automatically enters sleep within 1ms; This saves MCU's working time and reduces power consumption.
- Similarly, any mode switching can use this feature. After the module processes the current mode event, it will automatically enter the new mode within 1ms; thus eliminating the need for the user to query AUX and achieve the purpose of fast switching; For example, switching from the transmit mode to the receive mode; the user MCU can also enter sleep before the mode switch, and use the external interrupt function to acquire the AUX change, thereby performing mode switching.
- This operation mode is very flexible and efficient, and is designed according to the user's MCU's operation convenience, and can reduce the workload of the entire system as much as possible, improve system efficiency, and reduce power consumption.

6.2 Normal mode (Mode 0)

Type	When M0 = 0, M1 = 0, the module works on Mode 0
Transmitting	The module receives the users' data of serial port, and transmit 58 bytes wireless data packet. When the input data packet reaches 58 bytes, the module will start the wireless transmission, thus users can continue to input the transmitting data; When the input data packet is less than 58 bytes, the module will wait 3 bytes time, if there's no more data packet input, it means the data input finished, so the module will send all data packet out via wireless; After the module receives the first data packet, the AUX outputs low level; When module put all data into RF chip and start the transmission, the AUX outputs high level; At this time, it means the last data packet starts wireless transmission, users can continue to input 512 bytes data at most; The data packet sent in Mode 0 can be only received by the module with Mode 0 and Mode 1.
Receiving	The module always open the wireless receiving function on, then it can receive the data packet sent by Mode 0 and Mode 1. After receiving the data packet, the AUX of module outputs low level and after delaying 5ms, the wireless data will be transmitted via TXD pins of serial port. After all wireless data is transmitted via serial port, the AUX outputs high level.

6.3 WOR mode (Mode 1)

Type	When M0 = 1, M1 = 0, the module works on Mode 1
Transmitting	The condition of module starting data packet transmission and the AUX function equal to Mode 0. The only difference is that module will add wake-up code automatically before each data packet. The length of wake-up code depends on the wake-up time set by users, the purpose of wake-up code is to wake up the module with Mode 2; So, the transmitting data in Mode 1 can be received by the module with Mode 0, 1, 2.
Receiving	It equals to Mode 0.

6.4 Power saving mode (Mode 2)

Type	When M0 = 0, M1 = 1, the module works on Mode 2
Transmitting	The module is on sleep mode, serial port is close, so it cannot receive the serial port data of external MCU. Thus, this module does not feature wireless transmitting function.
Receiving	In mode 2, the transmitter must be work in Mode 1; Monitoring the wake-up code at regular time, once a valid wake-up code is received, the module continue to receive and wait for the entire valid data packet to be received; Then AUX outputs low level, after delaying 5ms, the serial port is open and the received wireless data will be transmitted via TXD, after that, AUX outputs high level; Wireless module continue to enter "Sleep-Monitor"working mode(polling); Set different wake-up time, the module has different receiving response time (max 2s) and different average power consumption(min 30uA); Users need to strike a balance between communication latency and average power consumption.

6.5 Sleep mode (Mode 3)

Type	When M0 = 1, M1 = 1, the module works on Mode 3
Transmitting	Transmitting the wireless data is unavailable.
Receiving	Receiving the wireless data is unavailable.
Configuration	Sleep mode can be used for module parameter setting. Use serial port 9600, 8N1 to set module working parameters via specific command format.
Note	When entering other modes from the sleep mode, the module will reconfigure the parameters. During the configuration process, AUX keeps low level; after that, AUX outputs high level, so it is recommended that the user detect the AUX rising edge.

7 Command format

In sleep mode (mode 3: M0 = 1, M1 = 1), the list of supported commands are as follows (only 9600, 8N1 format is supported when):

No.	Command format	Description
1	C0+Working parameters	The C0+5 byte working parameter is sent in hexadecimal format, 6 bytes in all, and must be sent continuously (power-down save)
2	C1+C1+C1	Three C1s are sent in hexadecimal format. The module returns the saved parameters and must be sent continuously.
3	C2+Working parameters	Send C2+5 byte working parameters in hexadecimal format, 6 bytes in all, must be sent continuously (power off without saving)
4	C3+C3+C3	Three C3s are sent in hexadecimal format. The module returns version information and must be sent continuously.
5	C4+C4+C4	Three C4s are sent in hexadecimal format, and the module will generate a reset and must be sent continuously.

7.1 Factory default parameter

Factory default parameter value: C0 00 00 18 50 44							
Module Model	Frequency	Address	Channel	Air data rate	Baud Rate	Serial port format	Transmitting power
E31-230T33D	230MHz	0x0000	0x19	1.2kbps	9600	8N1	2W

7.2 Working parameter reading

Instruction format	Detailed description
C1+C1+C1	In sleep mode (M0=1, M1=1), a command (HEX format) is issued to the module serial port: C1 C1 C1, the module will return the current configuration parameters, such as: C0 00 00 1A 17 44.

7.3 Version number reading

Instruction format	Detailed description
C3+C3+C3	In sleep mode (M0=1, M1=1), a command (HEX format) is issued to the module serial port: C3 C3 C3, the module will return the current configuration parameters, such as: C3 32 xx yy; the second byte represents the frequency, if it's 32, it is the applicable frequency of 433MHz, if it's 38, it is the applicable frequency of 470MHz, if it's 45, it is the applicable frequency of 868MHz; if it's 44, it is the applicable frequency of 915MHz; if it's 46, it is the applicable frequency of 170MHz; xx represents the version number, yy represents other features of module.

7.4 Reset instruction

Instruction format	Detailed description
C4+C4+C4	In sleep mode (M0=1, M1=1), a command (HEX format) is issued to the module serial port: C4 C4 C4, the module will generate a reset; during the reset process, the module performs self-test, AUX output low level, After the completion of reset, the AUX outputs high and the module starts to work normally. At this time, Users can switch modes or initiate the next instruction.

7.5 Parameter setting instruction

0	Name	Description	Note	
0	HEAD	Fixed 0xC0 or 0xC2, which indicates that this frame data is a control command	Must be 0xC0 or C2 C0: The set parameters will be saved after power down. C2: The set parameters will not be saved after power down.	
1	ADDH	High byte of module address (default 00H)	00H-FFH	
2	ADDL	Low byte of module address (default 00H)	00H-FFH	
3	SPED	7 6	Serial parity bit	The serial port mode of the two communication parties can be different
		0 0	8N1 (default)	
		0 1	8O1	
		1 0	8E1	
		1 1	8N1 (equals to 00)	
		5 4 3	TTL Serial port rate (bps)	The baud rate of both parties can be different.
		0 0 0	Serial port baud rate 1200	The serial port baud rate has nothing to do with the wireless transmission
		0 0 1	Serial port baud rate 2400	
0 1 0	Serial port baud rate 4800			

		0	1	1	Serial port baud rate 9600 (default)	parameters, and does not affect the wireless transmission and reception characteristics.		
		1	0	0	Serial port baud rate 19200			
		1	0	1	Serial port baud rate 38400			
		1	1	0	Serial port baud rate 57600			
		1	1	1	Serial port baud rate 115200			
				2	1	0	Wireless air data rate (bps)	The lower the air speed, the longer the distance, the stronger the anti-interference performance and the longer the transmission time. The wireless transmission rates of both communicating parties must be the same.
				0	0	0	Air data rate 1.2k (default)	
				0	0	1	Air data rate 2.4k	
				0	1	0	Air data rate 4.8k	
				0	1	1	Air data rate 9.6k	
				1	0	0	Air data rate 19.2k	
				1	0	1	Air data rate 38.4k	
				1	1	0	Air data rate 50k	
				1	1	1	Air data rate 70k	
4	CHAN	7	6	5	Keep and unused	Write 0.		
		Communication channel				00H-3FH, correspond 225 ~ 237.6MHz		
		5, 4, 3, 2, 1, 0: (225M + CHAN * 0.2M), default 19H (230M)						
5	OPTION	7	Fixed point send enable bit (similar to MODBUS)			When value is 1, the first 3 bytes of each user data frame are used as the high and low addresses and channels. When transmitting, the module changes its own address and channel, and when it is finished, it restores the original settings.		
		0	Transparent transmission mode					
		1	Fixed point transmission mode					
		6	IO drive mode (default 1)			This bit is used to enable the internal pull-up resistor of the module. Open-drain mode is more adaptable, and in some cases an external pull-up resistor may be required.		
		1	TXD、AUX push-pull output, RXD pull up input					
		0	TXD、AUX open-drain outputs, RXD open-drain inputs					
		5	4	3	Wireless wakeup time		Both transmitter and receiver module work in mode 0. The delay time is invalid and can be any value. The transmitter works in mode 1, and will continue to transmit the call code for the corresponding time. The receiver works in mode 2, which refers to the receiver's listening interval (wireless wake-up) and can only receive data from the module working in mode 1.	
		0	0	0	250ms (default)			
		0	0	1	500ms			
		0	1	0	750ms			
		0	1	1	1000ms			
		1	0	0	1250ms			
		1	0	1	1500ms			
		1	1	0	1750ms			
		1	1	1	2000ms			
		2	FEC switch			After the FEC is turned off, the actual data transmission rate is increased, but the anti-interference ability is weakened and the distance is slightly closer. Please choose according to the actual		
		0	Turn off FEC					
1	Open FEC (default)							

					application.	Both sides of the communication must be turned on or off.				
		1	0	Transmitting power (Approximate value)		The external power supply must provide more than 2A current output capability. And ensure that the power supply ripple is less than 100mV.				
		0	0	33dBm (default)						
		0	1	33dBm						
		1	0	33dBm						
		1	1	33dBm						
For example (The meaning of the No. 3 "SPED" byte) :										
The binary digit of the byte		7	6	5	4	3	2	1	0	
Specific value (Users configure)		0	0	0	1	1	0	1	0	
Meaning		Serial parity bit 8N1		Serial port baud rate 9600			Air data rate 2.4k			
Corresponding hexadecimal		1			A					

8 Hardware design

- It is recommended to use a DC regulated power supply to supply power to the module. The power supply ripple factor should be as small as possible, and the module needs to be reliably grounded.
- Please pay attention to the correct connection of the positive and negative poles of the power supply. If the reverse connection is made, the module may be permanently damaged.
- Please check the power supply to ensure that it's within the recommended power supply, or the module will be permanently damaged if it exceeds the maximum value.
- Please check the stability of the power supply, and the voltage cannot be fluctuated frequently;
- When designing the power supply circuit for the module, it is often recommended to reserve more than 30% of the margin, which is beneficial for long-term stable operation of the whole machine
- The module should be as far away as possible from the power supply, transformers, high-frequency wiring and other parts with large electromagnetic interference;
- High-frequency digital routing, high-frequency analog routing, and power routing must be avoided under the module. If it is necessary to pass the module, it is assumed that the module is soldered to the Top Layer, and the copper is applied to the Top Layer of the module contact part(Copper is well grounded), and must be close to the digital part of the module and routed in the Bottom Layer;
- Assuming that the module is soldered or placed in the Top Layer, it is also wrong to randomly route the Bottom Layer or other layers, which will affect the spurs and receiving sensitivity of the module in varying degrees;
- Assume that there are devices with large electromagnetic interference around the module that will greatly affect the performance of the module. It is recommended to keep away from the module according to the strength of the interference. If necessary, appropriate isolation and shielding can be done.
- Assume that there are traces with large electromagnetic interference around the module (high-frequency digital, high-frequency analog, power trace), which will greatly affect the performance of the module. It is recommended to stay away from the module according to the strength of the interference. If possible, users can do some proper isolation and shielding;
- If the communication line uses 5V level, it must be connected in series with 1k-5.1k resistor (not recommended,

there is still risk of damage);

- Try to stay away from some physical layers which is 2.4GHz TTL protocol, for example: USB3.0;
- The antenna installation structure has a great influence on the performance of the module. Make sure that the antenna is exposed, preferably vertically. When the module is installed inside the casing, a good antenna extension cable can be used to extend the antenna to the outside of the casing;
- The antenna can not be installed inside the metal case, which will greatly reduce the transmission distance.

9 FAQ

9.1 Transmission distance is not ideal

- When there is a linear communication obstacle, the communication distance will be correspondingly reduced;
- Temperature, humidity, and co-channel interference will lead to an increase in communication packet loss rate;
- The ground absorbs and reflects radio waves, so the test results close to the ground are poor.
- Seawater has a strong ability to absorb radio waves, so the seaside test results are poor.
- There are metal objects near the antenna, or placed in the metal shell, the signal attenuation will be very serious;
- Power register setting error, air data rate setting is too high (the higher the air data rate, the closer the distance);
- The low voltage of the power supply is lower than the recommended value at room temperature, and the lower the voltage, the smaller the power;
- The matching degree of antenna and module is poor, or the quality of the antenna itself.

9.2 Module is easy to damage

- Please check the power supply to ensure that it's within the recommended power supply, or the module will be permanently damaged if it exceeds the maximum value.
- Check the stability of the power supply and the voltage cannot be fluctuated frequently.
- Please ensure that the installation process is anti-static, and the high-frequency components are electrostatically sensitive.
- Please ensure that the humidity during installation and use is not too high because some components are humidity sensitive devices.
- If there is no special demand, it is not recommended to use it at too high or too low temperature.

9.3 Bit error rate is too high

- There are co-channel signal interference nearby, away from interference sources or modify frequency and channel to avoid interference;
- The undesirable power supply may also cause messy code, and ensure the reliability of the power supply.
- The quality of extension line and feeder are poor or too long, which also cause high bit error rate;

10 Welding operation guidance

This type is full-sized module, when the welder welds the module, he must be welding according to the anti-static

regulation. This product is allergic to static, randomly welding the module will have the chance of damaging it permanently.

11 E31 Series

Product Model	Chip	Frequency Hz	Transmitting power dBm	Test distance km	Air data rate bps	Packaging	Size mm	Antenna
E31-230T33D	AX5243	230M	33	8	1.2k~70k	DIP	37 * 60	SMA-K
E31-230T27D	AX5243	230M	27	5	1.2k~70k	DIP	24 * 43	SMA-K
E31-230T17D	AX5243	230M	17	2	1.2k~70k	DIP	21 * 36	SMA-K
E31-433T33D	AX5243	433M	33	8	1.2k~70k	DIP	37 * 60	SMA-K
E31-433T30D	AX5243	433M	30	6	1.2k~70k	DIP	24 * 43	SMA-K
E31-433T27D	AX5243	433M	27	4	1.2k~70k	DIP	24 * 43	SMA-K
E31-433T17D	AX5243	433M	17	2.1	1.2k~70k	DIP	21 * 36	SMA-K
E31-433T17S	AX5243	433M	17	2	1.2k~70k	SMD	17 * 30	Stamp hole+IPEX
E31-433T17S3	AX5243	433M	17	2	1.2k~70k	SMD	16 * 26	Stamp hole+IPEX

12 Antenna Instruction

12.1 Antenna recommendation

The antenna plays an important role in the communication process. The inferior antenna often has a great impact on the communication system. Therefore, we recommend our antennas, which have excellent performance and reasonable price, to support our wireless modules.

Product Model	Type	Frequency Hz	Interface	Impedance Ω	Height	Cable	Features
TX230-XPB-300	Sucker antenna	230M	SMA-J	50	74.5cm	300cm	Vehicle sucker antenna, super high gain
TX230-XP-200	Sucker antenna	230M	SMA-J	50	35cm	200cm	Sucker antenna, high gain
TX230-JK-20	Rubber antenna	230M	SMA-J	50	200mm	-	Flexible, omni antenna
TX230-JK-11	Rubber antenna	230M	SMA-J	50	110mm	-	Flexible, omni antenna

13 Batch packaging method

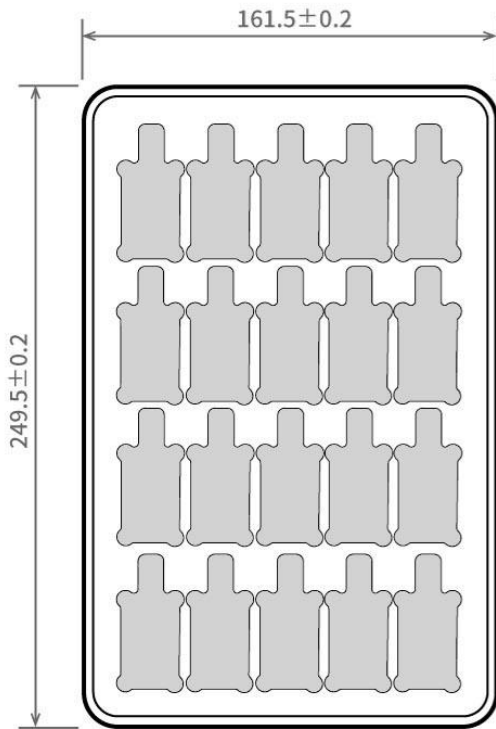

Unit: mm
Each Layer: 20 pcs
Each Package: 5 layers

Revise history

Version	Date	Description	Issued by
1.00	2017-11-17	Initial version	huaa
1.20	2018-01-29	Content updated	huaa
1.30	2018-10-17	New model added	huaa
1.40	2020-7-9		Li
1.50	2023-12-26	Content revision	Bin

About us

Technical support: support@cdebyte.com

Documents and RF Setting download link: <https://www.cdebyte.com>

Thank you for using Ebyte products! Please contact us with any questions or suggestions: info@cdebyte.com

Web: <https://www.cdebyte.com>

Address: Innovation Center D347, 4# XI-XIN Road, Chengdu, Sichuan, China

