



Chengdu Ebyte Electronic Technology Co.,Ltd

# Wireless Modem

## User Manual



## **NB124** **Dual Serial Port Server User Manual**

All rights to interpret and modify this manual belong to  
Chengdu Ebyte Electronic Technology Co., Ltd.

# Content

Chapter 1	Product Introduction .....	1
1.1	Functions and Features .....	1
Chapter 2	Quick Start .....	2
2.1	Hardware preparation .....	2
2.2	Software Preparation .....	2
2.3	Device default parameter test steps .....	3
2.3.1	Hardware connection .....	3
2.3.2	Device parameter configuration .....	3
2.3.3	Turn off the computer firewall .....	4
2.3.4	Open “serial port assist” .....	5
2.3.5	Open Net assist .....	5
2.3.6	TX, RX data Test .....	6
Chapter 3	Product Review .....	7
3.1	Technical Parameters .....	7
3.2	Interface description .....	8
3.3	Indicator light description .....	9
3.4	Size .....	11
Chapter 4	Basic functions .....	12
4.1	Correspondence between channel and serial port .....	12
4.2	Local network parameters .....	12
4.2.1	Local IP .....	12
4.2.2	DNS (domain name resolution) .....	12
4.2.3	Reconnection cycle for Network disconnection .....	12
4.2.4	Timeout restart (restart without data) .....	13
4.3	Hardware reset to factory .....	13
4.4	Device working mode .....	13
4.4.1	TCP Server .....	13
4.4.2	TCP Client .....	14
4.4.3	UDP Server .....	14
4.4.4	UDP Client .....	14
4.4.5	HTTP client .....	15
4.4.6	MQTT client .....	17
4.6	Channel port .....	20
Chapter 5	Advanced Features .....	21
5.1	Heartbeat package and registration package .....	21
5.1.1	Heartbeat package .....	21
5.1.2	Registration package .....	21
5.2	Short connection .....	22
5.3	Serial buffer cleaning .....	22
5.4	Modbus gateway .....	23
5.4.1	Simple Protocol Conversion .....	23
5.4.2	Multi-host mode .....	25

5.4.3 Storage gateway .....	26
5.4.4 Configurable Gateway .....	27
5.4.5 Automatically upload .....	29
5.5 Firmware upgrade .....	30
5.5.1 UDP upgrade .....	30
5.5.2 Serial upgrade .....	32
Revision History .....	34
About Us .....	34

# Chapter 1 Product Introduction

NB124 is a 2-way serial port server. It integrates the TCP/IP protocol stack inside, which can realize data transparent transmission from the 2-way serial port to the Ethernet port. The device has the function of ModBus gateway, supports Modbus TCP to RTU, and supports automatic polling. The product adopts industrial-grade standard design to ensure the stability of the equipment in harsh working environments, and the rich indicator lights are used to feedback the different working states of the equipment.



## 1.1 Functions and Features

- ◆ Stable and reliable industrial design, high-level port protection;
- ◆ Abundant LED status indicators to quickly locate the working status of the device;
- ◆ Support Phoenix terminal or DC power supply, DC 8-28V wide voltage input, support reverse connection protection;
- ◆ Support terminal interface (RS485/RS422) and standard DB9 interface (RS232);
- ◆ The baud rate supports 2400~115200bps, and supports multiple verification methods;
- ◆ Support multiple registration packets and heartbeat packet sending, such as connection sending MAC, connection sending customization, etc.;
- ◆ Supports stable and reliable host computer and AT command configuration, independent configuration of four channels does not affect each other;
- ◆ Support DNS domain name resolution, domain name resolution server can be configured;
- ◆ Support DHCP to dynamically obtain IP, subnet mask, default gateway, DNS server address;
- ◆ Support multiple working modes TCP client, TCP server, UDP client, UDP server, MQTT client, HTTP client;
- ◆ The 2-way server mode can be turned on at the same time, supporting 14 clients to dynamically allocate and access, and a single server supports 15 clients to access;
- ◆ Support UDP server mode with memory mode, records the UDP address of the last communication, and uses it as the destination address of the next communication;
- ◆ Support a variety of Modbus gateways, which can realize the active reporting of RTU devices, support the mutual conversion of Modbus TCP and Modbus RTU protocols, and can be configured as a storage mode to automatically collect device data, or use a multi-host mode with one question and one answer;
- ◆ Support MQTT gateway function, fast access to Alibaba Cloud and standard MQTT3.1.1 servers (OneNET, Baidu Cloud, Huawei Cloud, etc.);
- ◆ Support Modbus data to actively report to TCP transparent transmission server, MQTT server and other servers;
- ◆ Support HTTP client mode, use HTTP/1.1 protocol, can be configured as GET, POST two request methods;
- ◆ Support TCP/IP direct communication or connect communication through "virtual serial port";
- ◆ Abundant independent LED status indicators, supporting links, network cables, data sending and receiving, etc.;
- ◆ Support the host computer to perform firmware upgrade or firmware switch through UDP or serial port;
- ◆ The isolation version supports independent hardware isolation of 2 RS485 serial ports.

## Chapter 2 Quick Start

### 2.1 Hardware preparation

One laptop with RJ45 network port;  
 One NB124 serial port server;  
 One DC12V 1A power adapter;  
 A network cable;  
 One USB to RS485 serial cable;  
 As is shown in the following figure:

		
<p>Laptop</p>	<p>Network Cable</p>	<p>NB124</p>
		
<p>DC 12V1A</p>	<p>USB to RS485 converter</p>	<p>wires</p>

**【Note】** Only use one RS485 interface for demonstration, and please use the corresponding USB converter for other interfaces;

### 2.2 Software Preparation

Serial port debugging assistant (XCOM), network debugging assistant (TCP/IP debugging assistant), Ebyte network configuration tool (configuration host computer), official website address: [www.cdebyte.com](http://www.cdebyte.com), product

details provide a download interface.

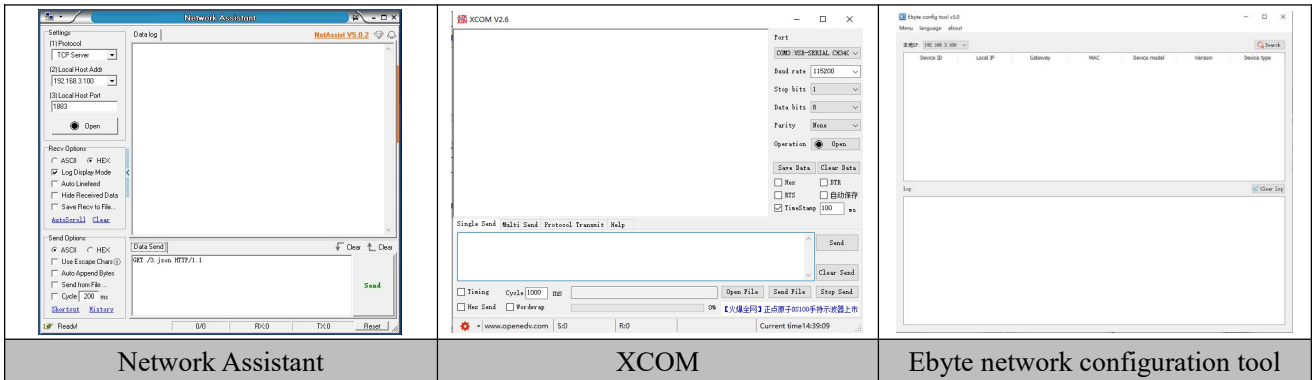

**【Note】** The serial port assistant software may be different from that provided on the official website, please refer to the similar one.

## 2.3 Device default parameter test steps

Different channels use the same IP but different local ports. For example, the factory-configured channel 1 corresponds to port 8001, and channel 2 corresponds to port 8002. For details, see the chapter "Correspondence Between Channels and Serial Ports".

### 2.3.1 Hardware connection



1. Connect the serial port server network port and the computer network port with a network cable;
2. Use a USB to RS485 serial cable to connect the USB port of the computer to any RS485 port of the serial server;
3. Use the power adapter (DC 8-28V) to power on the device, and observe whether the indicator light is normal, refer to "indicator light description";
4. After confirming that there is no problem with the status, proceed to the next step of configuration;

### 2.3.2 Device parameter configuration

In order to let users have a simple understanding of the serial server, we use the default parameters of the serial server to conduct data transparent transmission tests. The default parameters of NB124 serial server device are shown in the table below.

Item no.	Default parameters
IP address	192.168.3.7
Subnet mask	255.255.255.0
gateway	192.168.3.1
Channel 1 working mode	TCP_SERVER
Channel 1 local port	8001
Serial port baud rate	115200
Serial port parameters	NONE/8/1/NONE

Make sure that the computer IP and serial server IP are in the same network segment and cannot conflict. The inspection method is shown in the figure below:

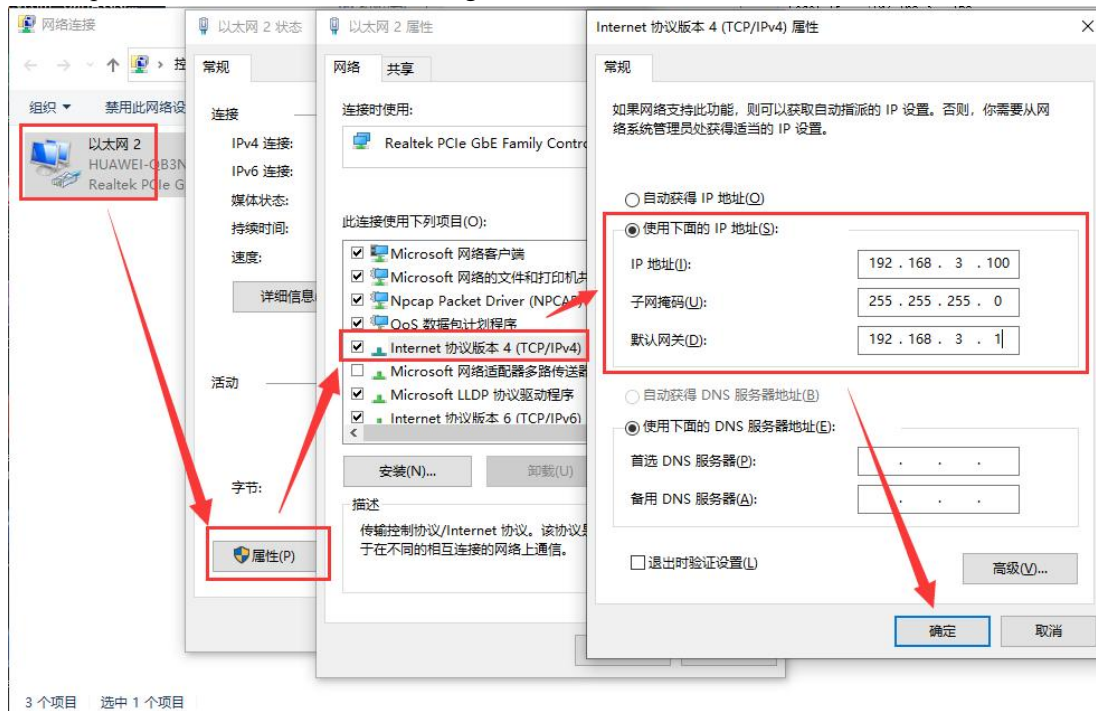

### 2.3.3 Turn off the computer firewall

If the communication is unsuccessful, the user can try to turn off the firewall on the computer and try again.

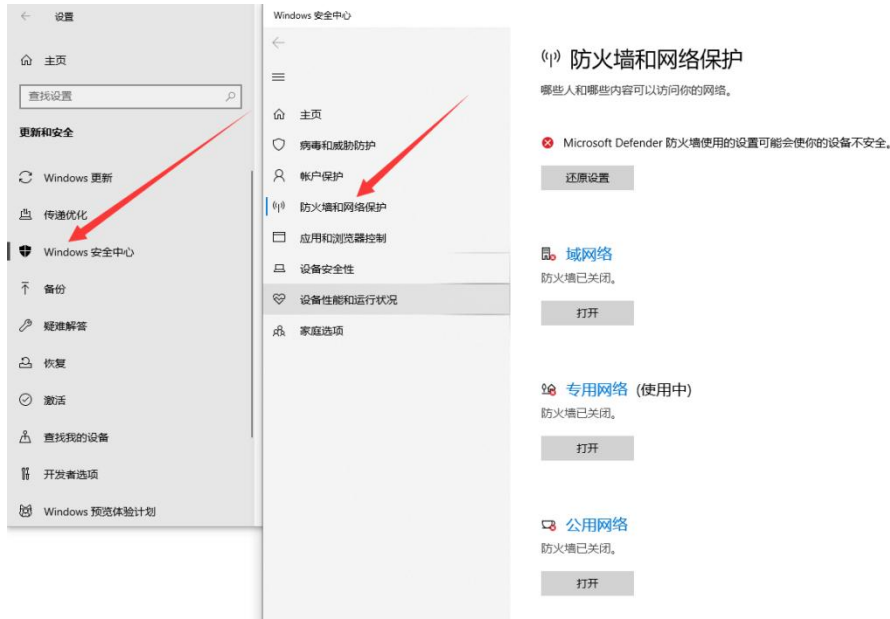

### 2.3.4 Open “serial port assist”

Choose correct COM number, configure correct serial port parameters ( 115200-8N1 ), open the serial port, as shown in the below:

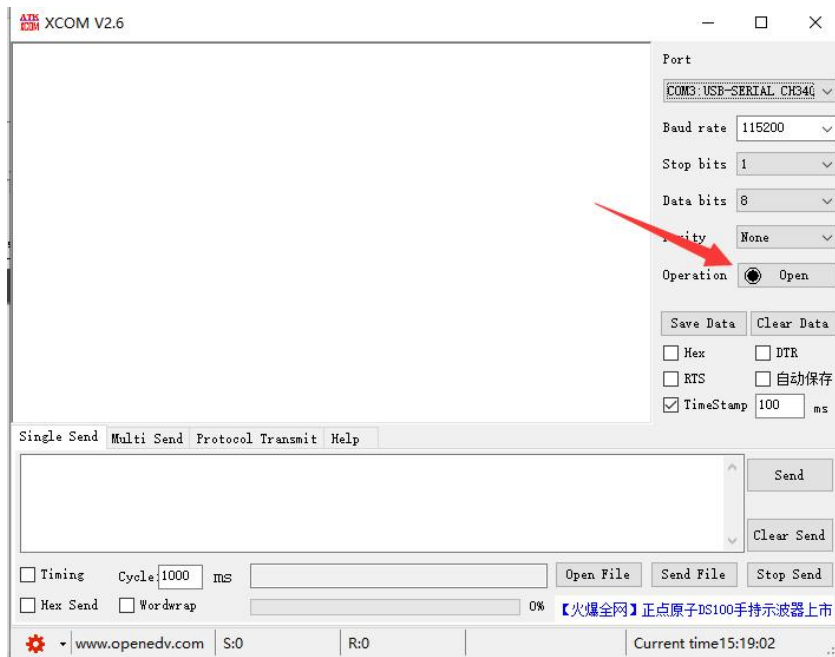

### 2.3.5 Open Net assist

Choose“TCP Client”, set remote IP as“192.168.3.7”, set remote port as“8001”as shown in below:



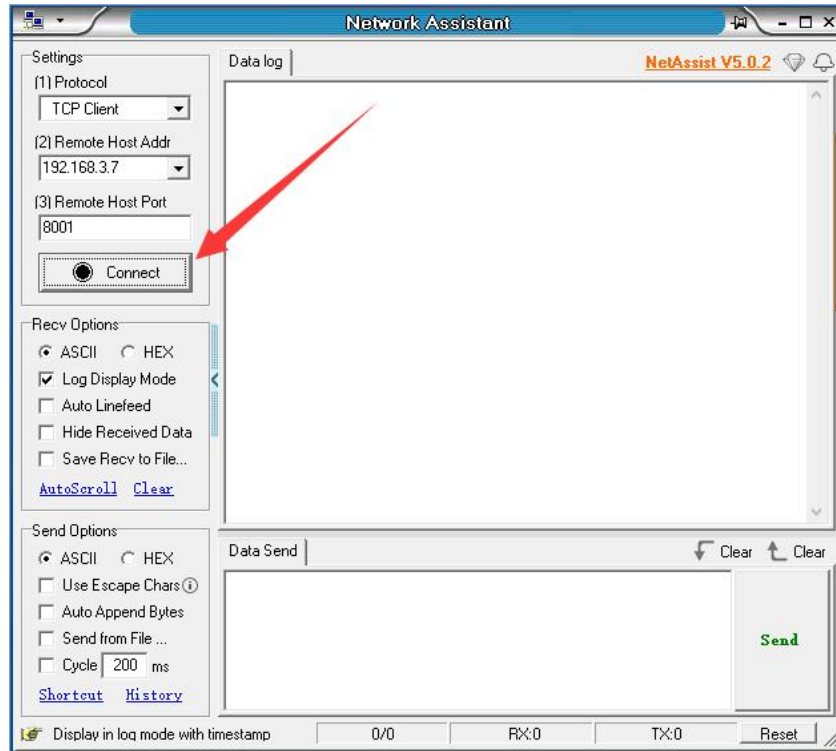

### 2.3.6 TX, RX data Test

Click the **send** button on the “Net assist” and “Serial port assist” respectively, it can do transparent transmission between net and serial port successfully, as shown in the below picture:

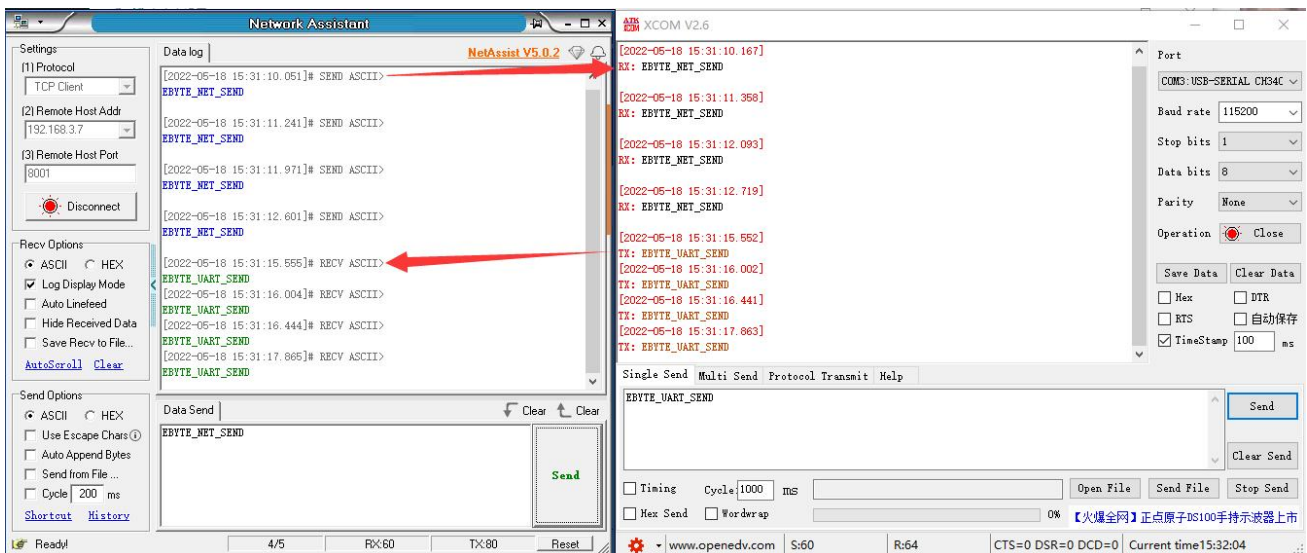

## Chapter 3 Product Review

### 3.1 Technical Parameters

Item	Port	Instructions
Power supply	Crimp terminal	DC 8~28 power supply;
	DC female head	Crimp terminal: 5.08mm Phoenix terminal DC female head: straight plug-in round hole, OD 5.5mm, ID 2.0mm;
Network Port	RJ45	10M
Serial Port	Channel 1~ Channel 2	Port 1 (RS485, 3.81mm Phoenix terminal); Port 2 (RS232, standard RS232, DB9 female head); Port 3 (RS422, 3.81mm Phoenix terminal);
Working Mode	TCP Server (default)、TCP Client、UDP Server、UDP Client、HTTP Client、MQTT Client	
Network Protocol	TCP/IP、UDP、MQTT、HTTP、IPv4、ICMP、APR、DHCP、DNS	
IP acquisition method	DHCP、State IP (default)	
DNS	support, address configurable	
Configure Method	Parameter configuration host computer, AT command	
IP address	192.168.3.7 (customizable)	
Local port	Channel 1~2: 8001-8002 (customizable)	
Subnet mask	255.255.255.0 (customizable)	
Gateway	192.168.3.1 (customizable)	
Serial cache	512 Byte	
Serial packaging mechanism	512 Byte	
Serial baud rate	2400 ~ 115200 bps (default 115200)	
Data bit	8	
Stop bit	1 (default)、2	
Parity bit	None (default)、Odd、Even	
Installation	Positioning hole	
Product size	173 x 95x26.5mm (LxWxH)	
Product weight	360g ± 5g	
Working temperature and humidity	-40 ~ +85°C、5% ~ 95%RH (no condensation)	

Storage temperature and humidity	-40 ~ +105°C、5% ~ 95%RH (no condensation)
----------------------------------	---

### 3.2 Interface description

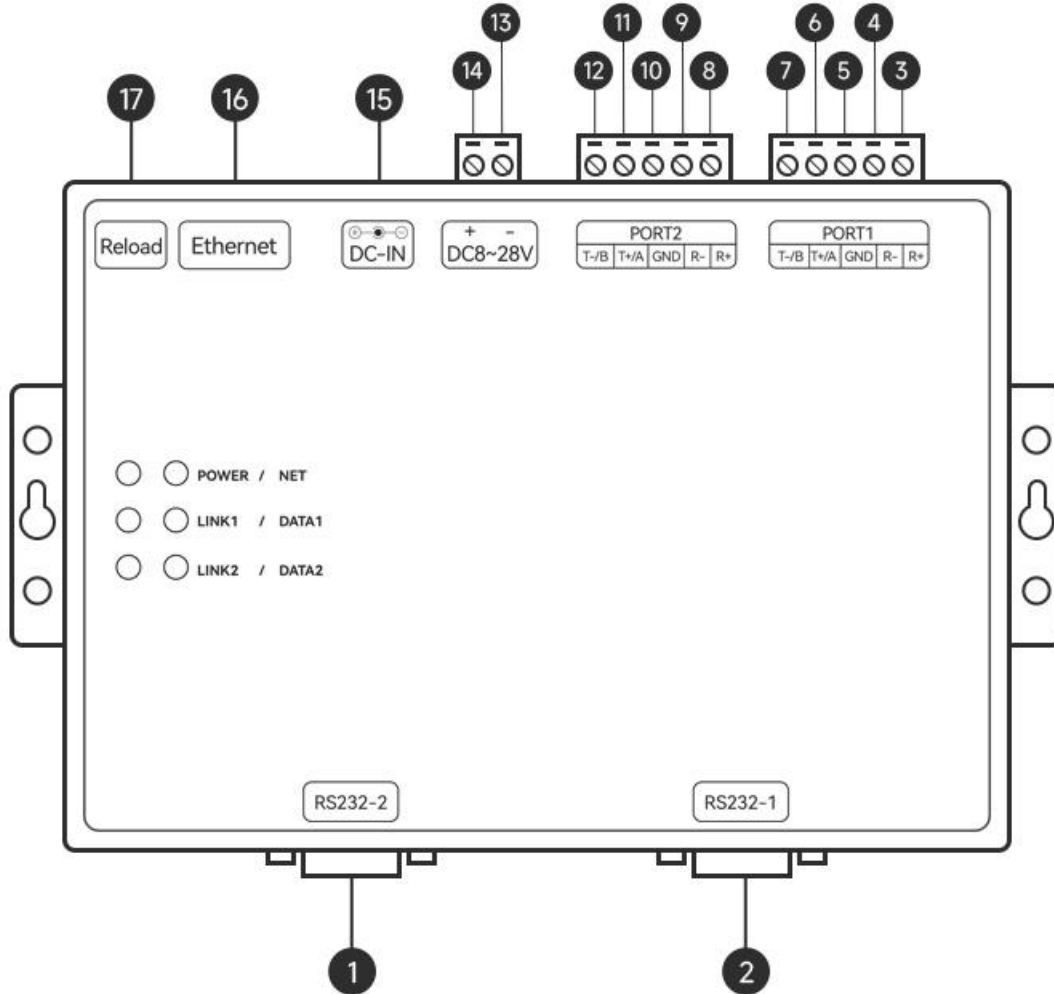

序号	名称	功能	说明
1	RS232-2	Serial port 2-RS232	Standard DB9 female head, 2-TXD、3-RXD、5-GND
2	RS232-1	Serial port 1-RS232	Standard DB9 female head, 2-TXD、3-RXD、5-GND
3	RS422-1-R+	Serial port 1-RS422 -R+	3.81mm Phoenix terminal
4	RS422-1-R-	Serial port 1-RS422 -R-	3.81mm Phoenix terminal
5	GND	Serial port 1 Ground	3.81mm Phoenix terminal

6	RS422-1-T+/A	Serial port 1-RS422 -T+ Serial port 1-RS485 A	3.81mm Phoenix terminal
7	RS422-1-T-/B	Serial port 1-RS422 -T- Serial port 1-RS485 B	3.81mm Phoenix terminal
8	RS422-2-R+	Serial port 2-RS422 -R+	3.81mm Phoenix terminal
9	RS422-2-R-	Serial port 2-RS422 -R-	3.81mm Phoenix terminal
10	GND	Serial port 2 Ground	3.81mm Phoenix terminal
11	RS422-2-T+/A	Serial port 2-RS422 -T+ Serial port 2-RS485 A	3.81mm Phoenix terminal
12	RS422-2-T-/B	Serial port 2-RS422 -T- Serial port 2-RS485 B	3.81mm Phoenix terminal
13	-	DC 8-28 V Negative pole	DC 8-28 V, 5.08mm Phoenix terminal;
14	+	DC 8-28 V Positive pole	DC 8-28 V, 5.08mm Phoenix terminal;
15	DC-IN	DC power input	DC 8-28 V; OD 5.5mm, ID 2.0mm straight plug-in round hole;
16	Ethernet	Ethernet interface	Standard RJ45 Ethernet interface
17	Reload	factory reset button	After long pressing for 5s, NET led is always on for 5s, and the device restores to factory settings

Note: Phoenix terminal cannot supply power with the DC plug at the same time.

### 3.3 Indicator light description

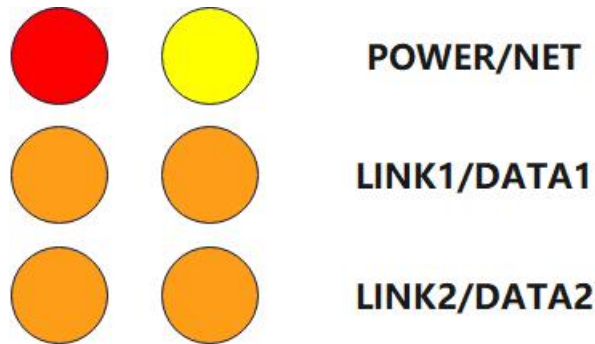

Label	Function	Instructions
POWER	Power indicator	Connect to the power supply, light up;
NET	Running lights	Disconnected: 100ms on and 900ms off, flashing periodically; Connected: flashing in 1s cycle;
LINK1	Channel 1 Status Indicator	No link connection: the indicator light is off; With link connection: the indicator light is always on; UDP mode: the indicator light is always on;

DATA1	Channel 1 data indicator	Data sending and receiving: flashes when the network or serial port sends and receives data;
LINK2	Channel 2 Status Indicator	No link connection: the indicator light is off; With link connection: the indicator light is always on; UDP mode: the indicator light is always on;
DATA2	Channel 2 data indicator	Data sending and receiving: flashes when the network or serial port sends and receives data;

**【Note】** Status of some special working mode indicator lights:

- 1、 Restore the factory, NET is always on for 5s, and the other indicators remain on and will go out until NET goes out;
- 2、 Wait for the firmware burning, except for the power indicator light, the other indicators will blink at a cycle of 50ms until the upgrade file is transferred, or exit the firmware burning waits;
- 3、 During the firmware burning operation, the indicator lights except the power indicator will flash at a cycle of 500ms until the upgrade is completed;

### 3.4 Size

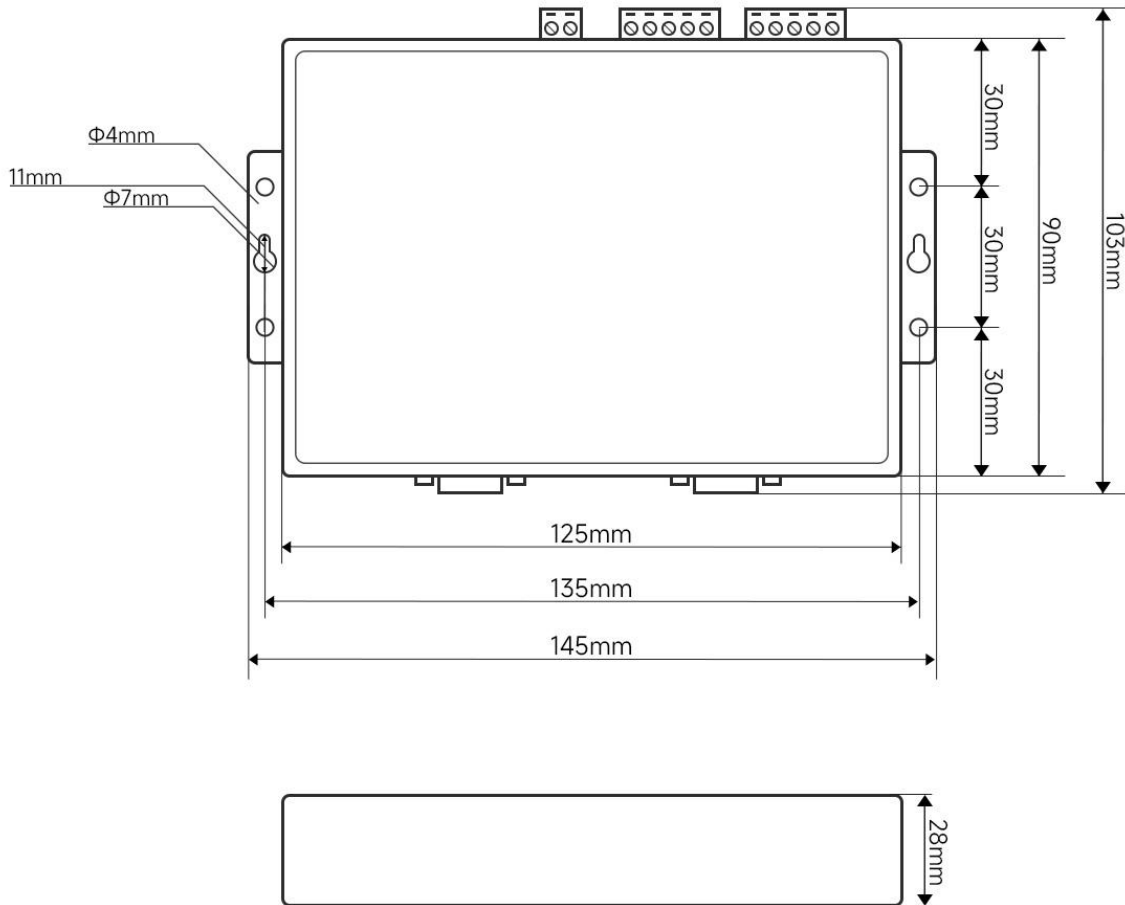

## Chapter 4 Basic functions

### 4.1 Correspondence between channel and serial port

Baud rate: 2400、4800、9600、14400、19200、38400、57600、76800、115200bps;

Data bit: Only supports 8 bits;

Parity bit: support no parity (NONE), odd parity (ODD), even parity (EVEN);

Hardware flow control: not supported;

Channel	Serial Port	Indicator	Serial protocol	Factory port, mode
Channel 1	COM1	PORT1	RS485、RS232、RS422	8001、TCPS
Channel 2	COM2	PORT2	RS485、RS232、RS422	8002、TCPS

### 4.2 Local network parameters

#### 4.2.1 Local IP

**STATIC (Static IP):** Users can define and configure IP, subnet mask, default gateway, domain name resolution server (DNS server);

**DHCP (dynamic IP acquisition):** The device logs in to the server to automatically obtain the IP address, subnet mask, gateway address, and DNS server address;

#### 4.2.2 DNS (domain name resolution)

When the user enters the domain name, the DNS server will be automatically queried, and the DNS server will retrieve the database to obtain the corresponding IP address. In the static IP mode, the user can customize the domain name resolution server to resolve private domain name server data. In the dynamic IP mode The device automatically follows the domain name resolution server configured by the routing device, and the user only needs to modify the DNS server of the routing device, no need to configure the device.

#### 4.2.3 Reconnection cycle for Network disconnection

When the device detects that it is disconnected from the server, it periodically initiates a

reconnection request. Therefore, the "disconnection reconnection time" will not affect the connection establishment time under normal circumstances. The user can customize the reconnection request period, and the default is 5s.

#### 4.2.4 Timeout restart (restart without data)

The device monitors data sending and receiving. If the device does not send and receive data for a long time, the device will automatically restart to ensure the stability of long-term work.

The default cycle of this function is 30 minutes, and the user can customize the cycle of restarting with timeout or no data.

### 4.3 Hardware reset to factory

Keep pressing the Reload pin of the device for 5s until the NET indicator stops flashing, keep the NET indicator on for 5s, and the device is restored to factory.

## 4.4 Device working mode

### 4.4.1 TCP Server

In the TCP Server mode, the device listens to the local port, accepts the connection request from the client and establishes a connection for data communication. When the Modbus gateway function is turned off, the device sends the data received by the serial port to all client devices connected to the device.

The number of clients that can be accessed by the server is dynamically adjusted. First, ensure that each channel of the 2 channels can establish a complete communication link. In addition, the device also has 14 dynamic access communication links. For example, if the device turns on the 2-channel server mode, each The server can access 8 client devices, or if the device opens 1 server, the server can connect to 15 client devices. If the number of client devices exceeds the access number, the device will refuse to connect.



## 4.4.2 TCP Client

When the device is working, it will actively initiate a connection request to the server and establish a connection to realize the interaction between serial port data and server data.

To use the client, you need to configure the IP address/domain name and target port of the target accurately.

The two channels can independently open 2-way TCP clients.

## 4.4.3 UDP Server

UDP Server means that the device does not verify the source IP address of the data when using the UDP protocol to communicate. After receiving a UDP data packet, it saves the source IP address and source port of the data packet, and sets it as the target IP and port, so The data sent by the device only sends data packets to the source IP address and port where the device received the data last time.

This mode is usually used in scenarios where multiple network devices communicate with this device, and the frequency is high, and the TCP Server cannot meet the conditions.

Using UDP Server requires the remote UDP device to send data first, otherwise the data cannot be sent normally.

**【Note】** In UDP mode, the data sent by the network to the device should be less than 512Bit per packet, otherwise it will cause data loss.

## 4.4.4 UDP Client

UDP Client is a connectionless transmission protocol that provides transaction-oriented simple and unreliable information transmission services. There is no connection establishment and disconnection, and data can be sent to the other party only by configuring the destination IP and destination port. It is usually used in data transmission scenarios where there is no requirement for the packet loss rate, the data packets are small and the sending frequency is fast, and the data is to be transmitted to the specified IP.

In UDP Client mode, the device will only communicate with the configured (target IP and target port) remote UDP device.

In this mode, the destination address is set to 255.255.255.255, and the sending data will be

broadcast on the entire network segment, but the sending and receiving devices need to ensure that the ports are consistent, and ensure the device can also receive broadcast data.

**【Note】** In UDP mode, the data sent by the network to the device should be less than 512Bit per packet, otherwise it will cause data loss.

### 4.4.5 HTTP client

This mode can realize HTTP automatic package function, and provides two methods of GET and POST. Customers can configure URL, Header and other parameters by themselves, and the device will send the package to realize fast communication between serial port data and HTTP server. URL and Header are the most The length supports 128 bytes of data, and the two channels can independently open the HTTP client mode without affecting each other.

The HTTP request data should be smaller than the packet length (512 bytes), otherwise the device will divide the request data into multiple packets for request, resulting in abnormal request.

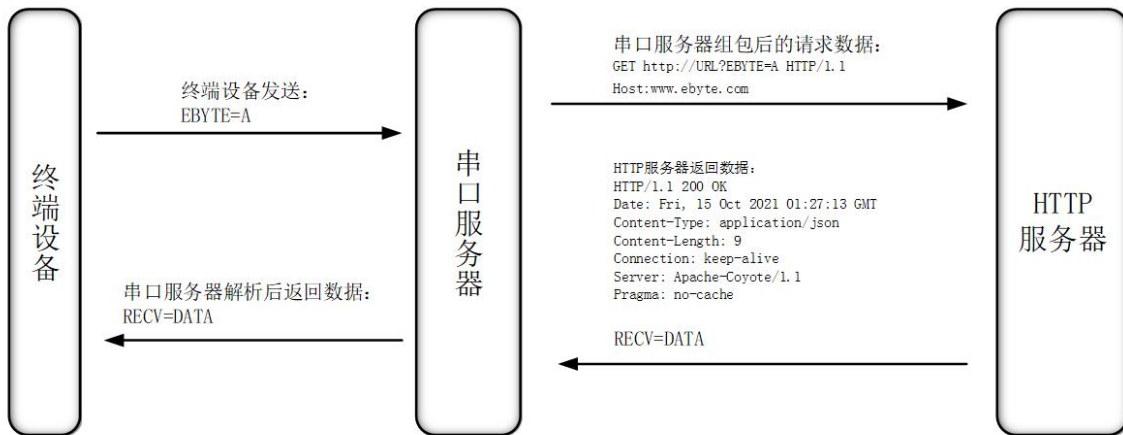

It supports configuring whether to return the HTTP protocol header, and the returned data is shown in the figure below:

返回数据带HTTP包头



```
HTTP/1.1 200 OK
Date: Fri, 15 Oct 2021 01:27:13 GMT
Content-Type: application/json
Content-Length: 9
Connection: keep-alive
Server: Apache-Coyote/1.1
Pragma: no-cache

RECV=DATA
```

返回数据不带HTTP包头



RECV=DATA

Configuration instructions: Turn on the upper computer, search for the device and enter the device configuration interface, configure the "network parameters" first, it is recommended to use the DHCP function to avoid incorrect configurations that cause device IP exceptions (network segment errors, IP conflicts, etc.), and then configure the channel using the HTTP function, support 2 channels to configure HTTP client mode at the same time, here is an example to explain by GET requesting "Baidu" webpage (URL: empty, HEADER: Host: www.baidu.com, target domain name: www.baidu.com, target port: 80 , the local port is recommended to use a random port), the specific configuration is shown in the figure below:

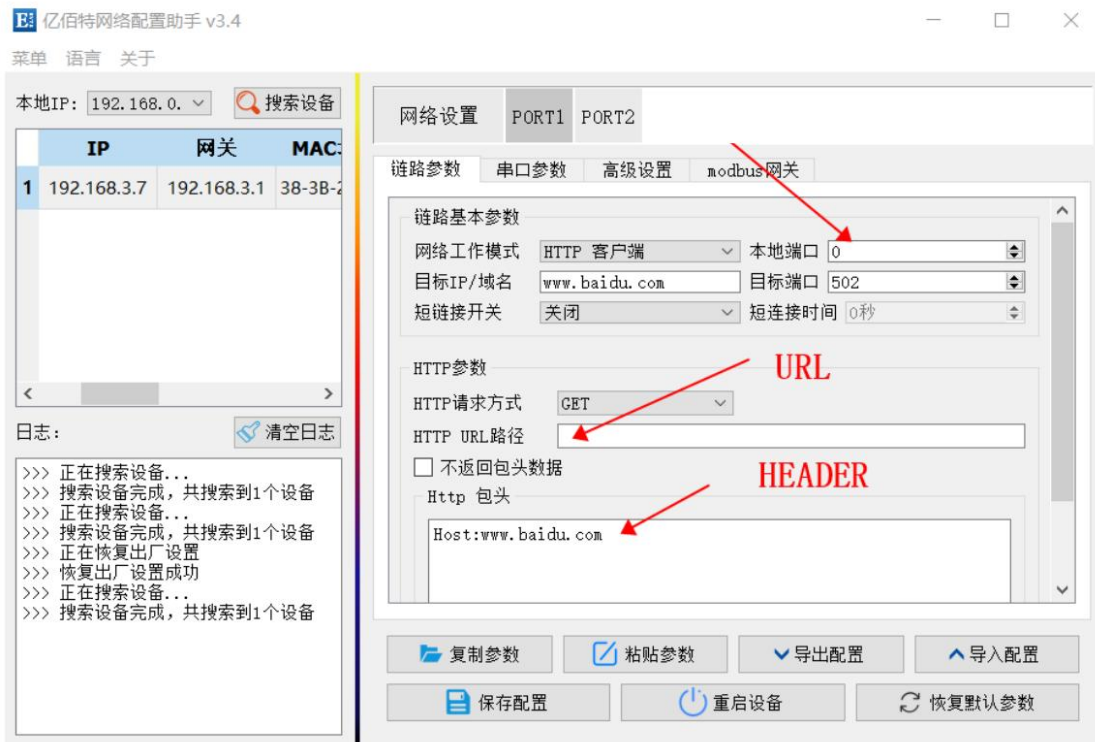

The request data is "/", use the serial port assistant to get the web page:

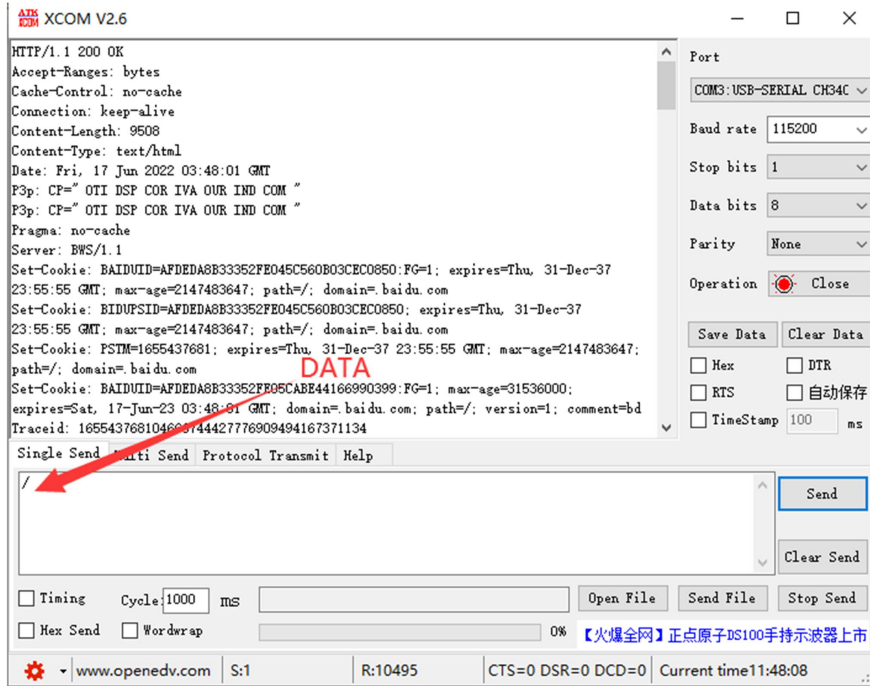

Instructions for POST, in the header data configured as a POST request, there is no need to configure the header of the data length separately (for example: Content-length: 2729), the device will automatically calculate the data length and group the packet to send, other header data needs to be manually configured, and support up to 128 bytes data configuration.

### 4.5.6 MQTT client

Support quick access to standard MQTT3.1.1 protocol servers (OneNET, Baidu Cloud, Huawei Cloud, user-built server types, etc.) and Ali cloud server. Support quality of service level configuration (Qos 0, Qos 1), support ultra-long text configuration, and facilitate better access to network service operators (server address, three elements, subscription and publishing addresses support up to 128 character configuration, Ali Cloud product password key 64 characters).

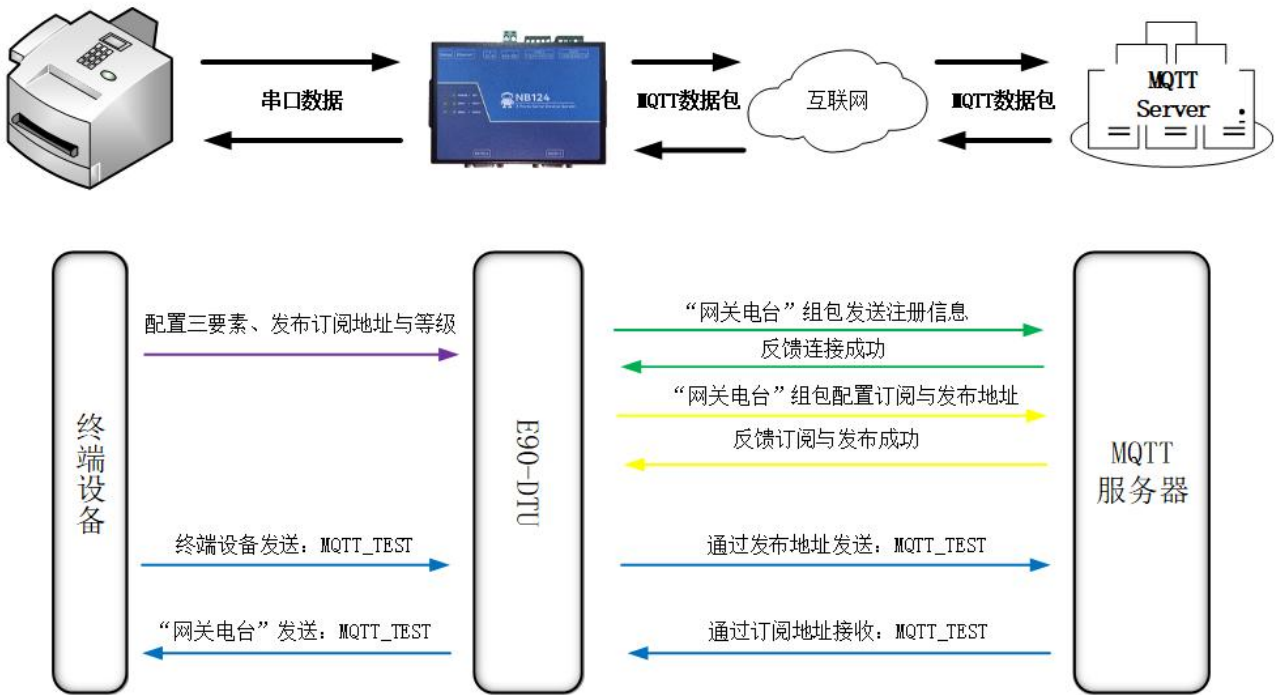

(1)、 To select the standard MQTT3.1.1, Baidu Cloud, OneNET, and Huawei Cloud configurations, you can refer to the following table to fill in the parameters:

Parameters	Standard MQTT3.1.1	Baidu Cloud	OneNET
Device name (Client ID)	Client ID	DeviceKey	Device ID
User Name (Device name)	User Name	IoTCoreId/DeviceKey	Product ID
Password (Device secret)	Password	DeviceSecret	Device name/User Password
PrductKey	Ali Cloud parameters, can be left blank		
Publish topic	MQTT publish topic address (dynamically generated by OneNET)		
Subscribe Topic	MQTT Subscribe Topic Address (dynamically generated by OneNET)		

**【Note】**

- Dynamic generation of topic address can use the same parameters to achieve the effect of data return, for example: OneNET publishes and subscribes to the same topic address: 123456, and data return can be achieved;
- Due to the adjustment of the MQTT platform (Baidu Cloud, Huawei Cloud, OneNET), the connection cannot be made after filling in the parameters, and the platform rules shall prevail;

Take the standard MQTT3.1.1 parameter filling as an example, as shown in the figure below:



(2)、Ali Cloud

It supports the use of Ali Cloud's "three elements" to directly connect to the server. To obtain the "three elements", as shown in the figure (only for demonstration cases, users need to use self-built parameters to connect):



Configure Topic for communication test:



Configuration theme description:

Select the corresponding product, click "Custom Topic" under the Topic class list (for details, please refer to the Alibaba Cloud documentation), click "Define Topic Class", configure the name as 1234 and grant publish and subscribe permissions (for realizing data return pass).

Configure the device connection parameters, as shown in the figure below (the left picture is the host computer, and the right picture is the webpage configuration):

```
{
  "ProductKey": "a1GihuTU1yN",
  "DeviceName": "DEV04",
  "DeviceSecret": "xxxxxxxxxxxxxxxxxxxxxxxxxxxx"
}
```

Ali cloud server address: ProductKey.iot-as-mqtt.cn-shanghai.aliyuncs.com:1883

Subscribe and publish Topic: /a1GihuTU1yN/DEV04/user/1234



Ali Cloud MQTT platform communication test:

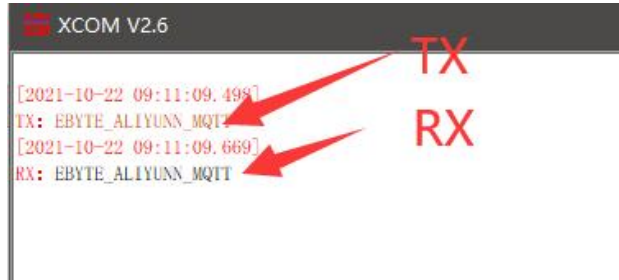

## 4.6 Channel port

### Random Port:

TCP client, UDP client, HTTP client, MQTT client can configure the local port as 0 (use random local port), server mode cannot use random port, otherwise the client cannot establish the connection correctly (The device is not properly listening on the port).

Using a random port connection can quickly re-establish the connection when the device is accidentally disconnected from the server, preventing the server from rejecting the connection due to four waved incomplete. It is recommended to use a random port in client mode.

When the device configures the TCP client, HTTP client, and MQTT client mode in the AT, it will automatically configure a random port, which can be canceled by customization.

### Static Port:

Device fixed port (factory default use: 8001-8002), TCP server mode device listens to the configured port, accepts the connection request from the client and establishes a connection for data communication, TCP client mode device initiates a connection request in fixed port.

## Chapter 5 Advanced Features

### 5.1 Heartbeat package and registration package

#### 5.1.1 Heartbeat package

In client mode, users can choose to send heartbeat packets and customize the heartbeat packet time. The heartbeat packet can choose network heartbeat packet and serial port heartbeat packet. It supports hexadecimal and ASCII code sending. This heartbeat packet is not MQTT heartbeat. It needs to be closed when using MQTT client mode. MQTT heartbeat can only set the "heartbeat period" in the "MQTT parameter configuration" column. The content of the MQTT heartbeat packet is restricted by the protocol and cannot be configured. It is recommended not to configure it for less than 60s. For example, the Ali cloud manual recommends using 120s.

Heartbeat packet sending mode:

1. The default is to turn off the heartbeat packet mode.
2. Serial mode -> The device sends heartbeat content to the serial bus according to the set heartbeat time interval.
3. Network port mode -> The device sends heartbeat content to the network port bus according to the set heartbeat time interval.

Customize the content of the heartbeat packet (support up to 40 bytes (ASCII) data, 20 bytes (HEX) data)

Customize the heartbeat packet sending time interval. When it is set to 0, the heartbeat packet function is turned off. When the value is greater than 0, the heartbeat packet function is turned on. When it is turned on, the range can be set: (1-65536) seconds, and the default value is 0.

#### 5.1.2 Registration package

In the client mode, the user can choose to send the registration package and customize the registration package time.

The registration package supports the following modes:

1. The MAC address (OLMAC) is sent when the network establishes a connection with the device.
2. When the network establishes a connection with the device, the data of the custom



registration package (OLCSTM) is sent.

3. After the connection between the network and the device is established, each packet of data sent by the device to the network will be preceded by a MAC address (EMBMAC).
4. After the connection between the network and the device is established, each packet of data sent by the device to the network will be preceded by custom registration packet data (EMBCSTM).

Customize the content of the registration package (support up to 40 bytes (ASCII) data, 20 bytes (HEX) data)

**【Note】** It is recommended not to use special characters (such as ", " \" /") when configuring the registration package. If you want to use it, it is recommended to use hexadecimal configuration.

## 5.2 Short connection

In client mode, short network connections are supported (this function is disabled by default). TCP short connections are mainly used to save server resource overhead, and are generally used in multi-point (multi-client) to one-point (server) scenarios.

The TCP short connection function is applied in the TCP Client mode. After the short connection function is turned on, it only requests to connect with the server when sending information. After the connection is successful, if the serial port does not receive data or the network port has no data to send and receive within the set time, the device will automatically disconnect.

When the short link hold time is set to 0, the short link function is disabled. When the setting range is (2-255) seconds, the short connection function is enabled, and the default hold time is 0 seconds (short connection is turned off).

## 5.3 Serial buffer cleaning

When the TCP connection is not established, the data received by the serial port will be placed in the buffer area. The serial port receiving buffer is 512 bytes. After the network connection is successful, you can choose to clear the serial port buffer or send the buffer through the network.

**Enable:** The device does not save the data received by the serial port before the connection is established.

**Disabled:** After the connection is established, the network will receive the data buffered by the serial port.

## 5.4 Modbus gateway

### 5.4.1 Simple Protocol Conversion

Convert Modbus RTU data to Modbus TCP data, or convert Modbus TCP data to Modbus RTU data, and realize the mutual conversion between Ethernet Modbus data and serial port Modbus data.

Simple protocol conversion can work in any mode (TCP client, TCP server, UDP client, UDP server, MQTT client), this gateway mode does not support multi-host operation. Please use "storage gateway" and "multi-host host mode" if need to use multi-host operation..

Simple protocol conversion configuration:



Modbus Poll and Modbus Slave software debugging:

Software connection settings:

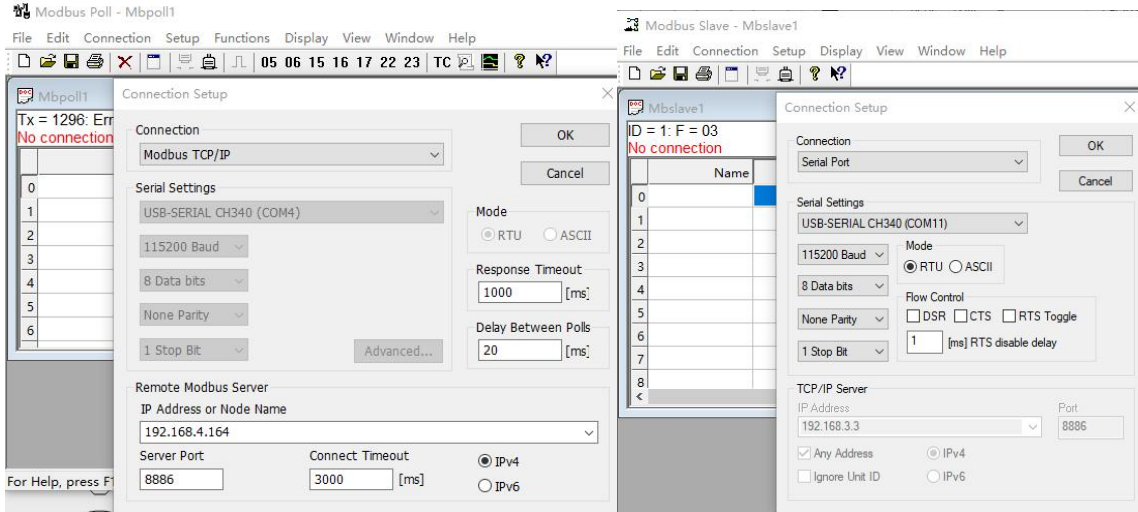

Software register reading and emulation configuration:  
Poll menu selection Setup → Read/Write Definition

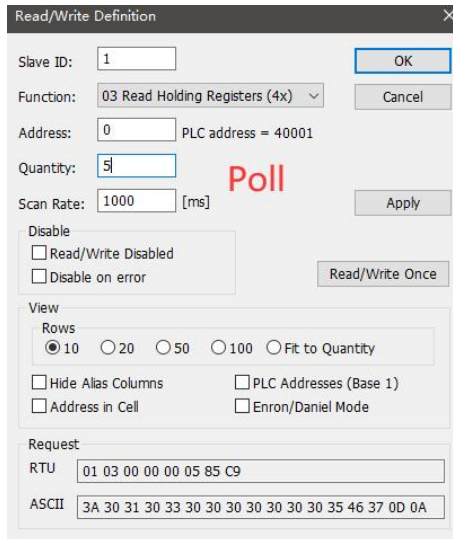

Slave menu selection Setup → Slave Definition

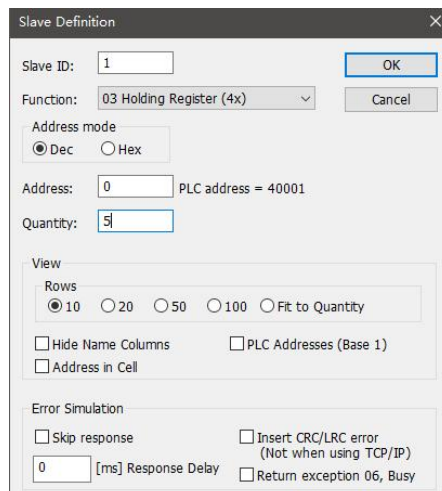

Communication demo:

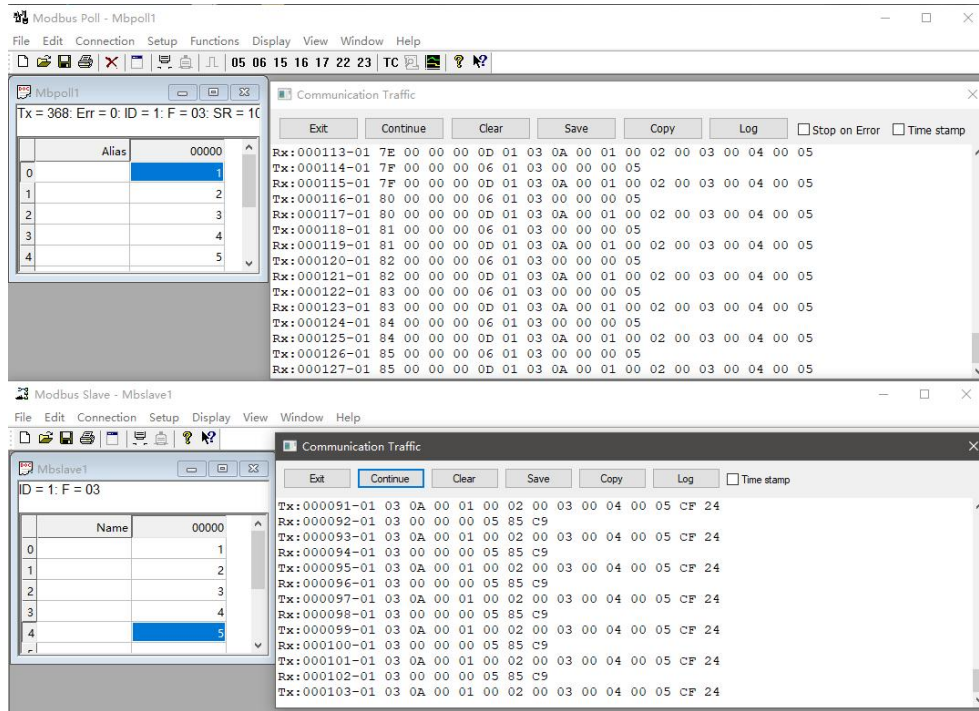

## 5.4.2 Multi-host mode

Relatively simple protocol conversion can only have one Modbus master station, while the multi-host mode can access multiple Modbus TCP hosts at the same time. When multiple Modbus hosts access at the same time, the Modbus gateway will perform bus occupancy scheduling (RS-485 bus Only one request can be processed at a time, while the multi-host mode will sort and process according to the TCP requests, and other links will wait), thus solving the problem of bus conflicts (currently, in single-server mode, up to 9 Modbus TCP host connections are supported, and multiple Attention should be paid to the matching of the request interval and the timeout time, otherwise the transmission rate of the serial port is much lower than the transmission rate of the Ethernet, resulting in packet loss. If you need a quick response, it is recommended to use a "storage gateway"), only supports working in TCP server mode, and the slave can only be on the serial port, otherwise it cannot work normally.

As the number of hosts increases, the Modbus timeout should be increased accordingly. If multiple hosts need continuous high-speed requests, it is recommended to use "storage gateway", and it is recommended to configure "simple protocol conversion" when there are no multiple hosts.



Refer to "Simple Protocol Conversion" for software configuration and register configuration, and open multiple Modbus Poll software at the same time (3 channels as an example, and a single server model can support up to 9 channels).

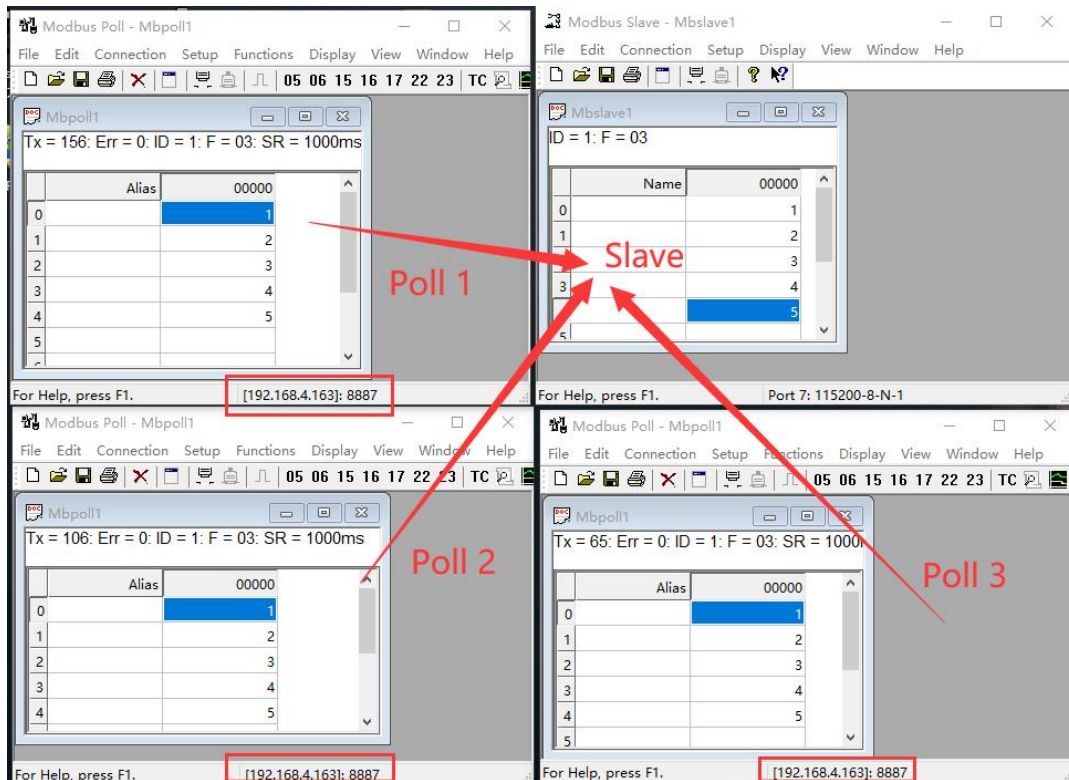

### 5.4.3 Storage gateway

The storage gateway not only arbitrates the bus data, but also stores repeated read instructions. When different hosts request the same data, the gateway does not need to ask the RTU device register status multiple times, but

directly returns the data cached in the storage area, which greatly To a certain extent, the multi-host request processing capability of the gateway is improved, and the time consumed by the entire request process is also shortened. Users can customize the polling interval of the storage area instructions and the instruction storage time according to their needs.

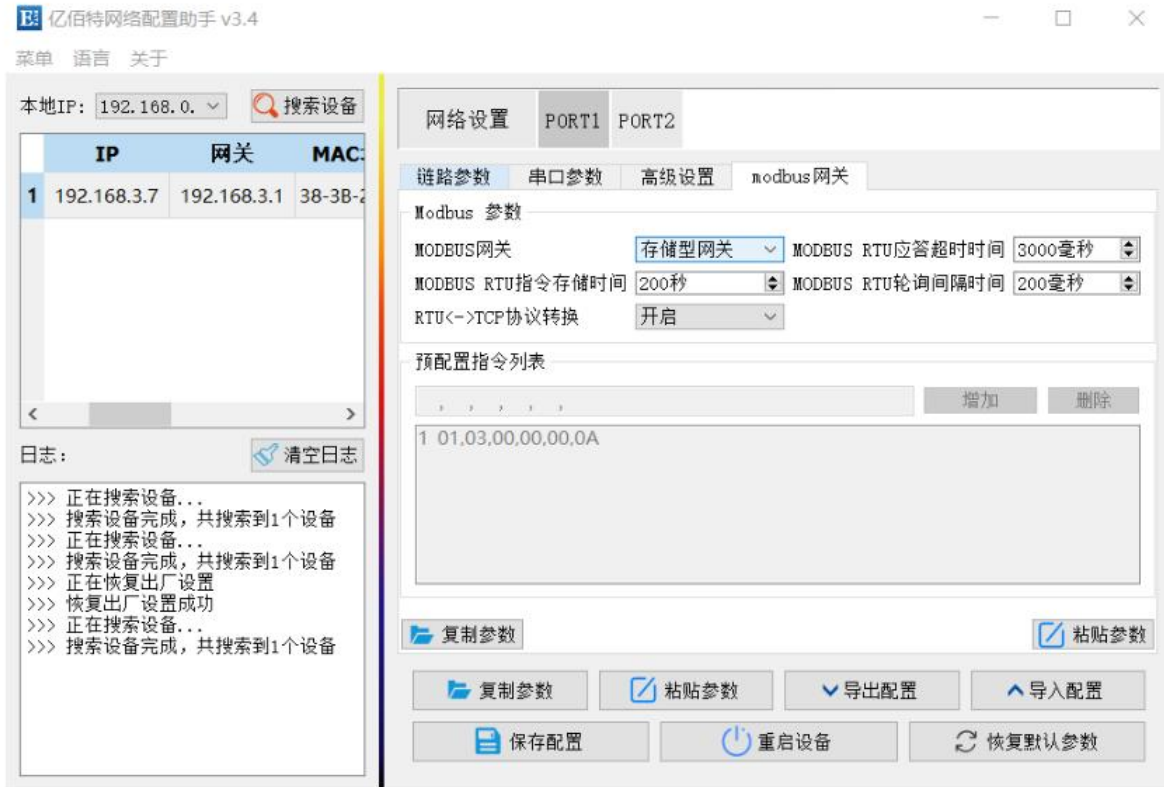

As an optimization of multi-host request performance, the storage gateway can only work in the TCP server mode, which improves the response speed of the network side.

Features:

- (1) The gateway has a 2K cache for storing instructions and returning results (reading 10 holding registers as an example, about 67 instructions and returning results can be stored);
- (2) The RTU response timeout automatically clears the cache to ensure the real-time and authenticity of the data;
- (3) The polling interval can be customized, 0-65535ms (default: 200ms);
- (4) The gateway will poll the RTU device according to the storage time of the command used for configuration. If the MODBUS host does not query the command again during the storage time, the gateway will automatically delete the storage command to release the cache;
- (5) The first command and control command (05, 06, 0F, 10 function codes) will directly access the RTU device;
- (6) Only support query result storage of 01, 02, 03, 04 Modbus function codes;

## 5.4.4 Configurable Gateway

The gateway automatically polls the RTU device registers according to the pre-configured MODBUS commands (only supports the configuration of MODBUS read commands), and the commands in the non-storage

table will directly operate the RTU device, and the frequently read commands can be stored in the gateway in advance, which can shorten the Response time (command to query configuration), the data will not be sent directly to the server and will only be returned after the request of the Modbus host, which is similar to the use method of "simple protocol conversion". If you need to automatically upload the data to the server, please select "automatic upload". Due to the above characteristics, the serial port side of the configurable gateway can only be connected to the Modbus slave station.



Instructions storage instructions (increase, instruction errors and format errors cannot be added):

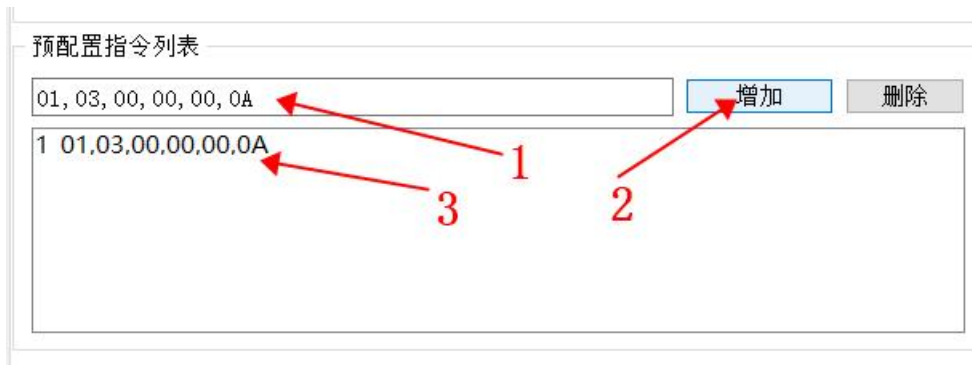

Instruction storage instructions (delete):



### 5.4.5 Automatically upload

In the client mode (TCP client, UDP client, MQTT client, HTTP client) the gateway will automatically poll the instructions stored in the instruction table and upload them to the server. You can choose the feedback format (Modbus RTU format or Modbus TCP format) according to your needs. ) and command polling interval (0-65535ms).

Instruction pre-storage refers to "Configurable Gateway - Instructions for Instruction Storage", and automatically uploads the host computer/webpage configuration:

TCP client demo (Modbus RTU format):

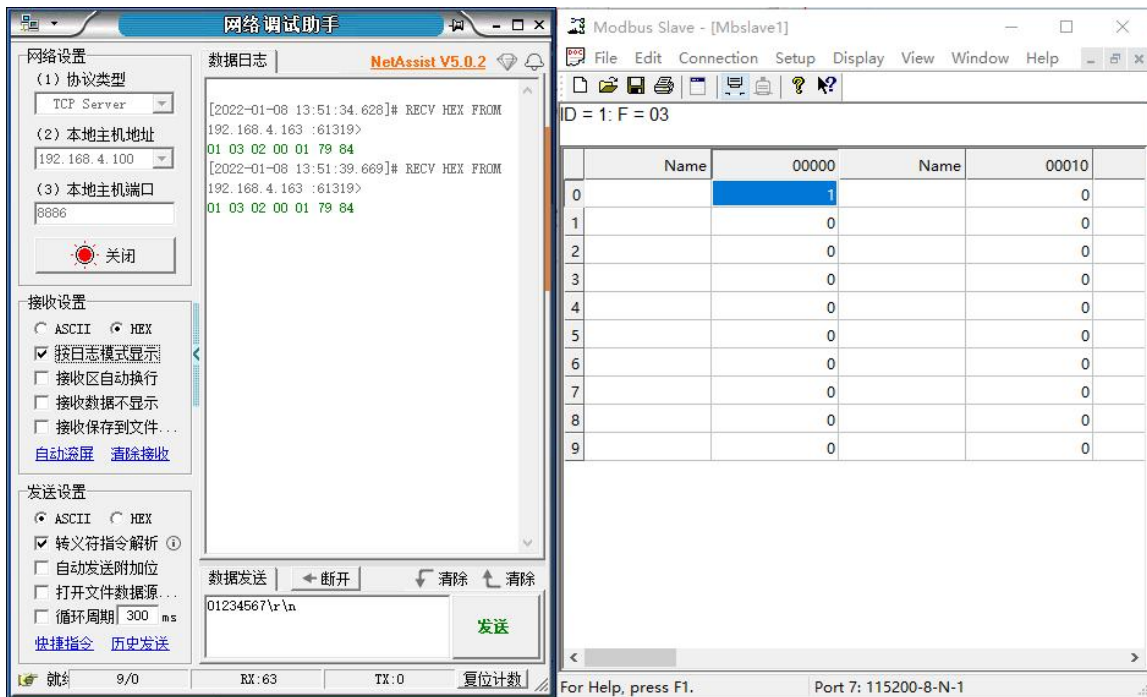

TCP client demo (Modbus TCP format):



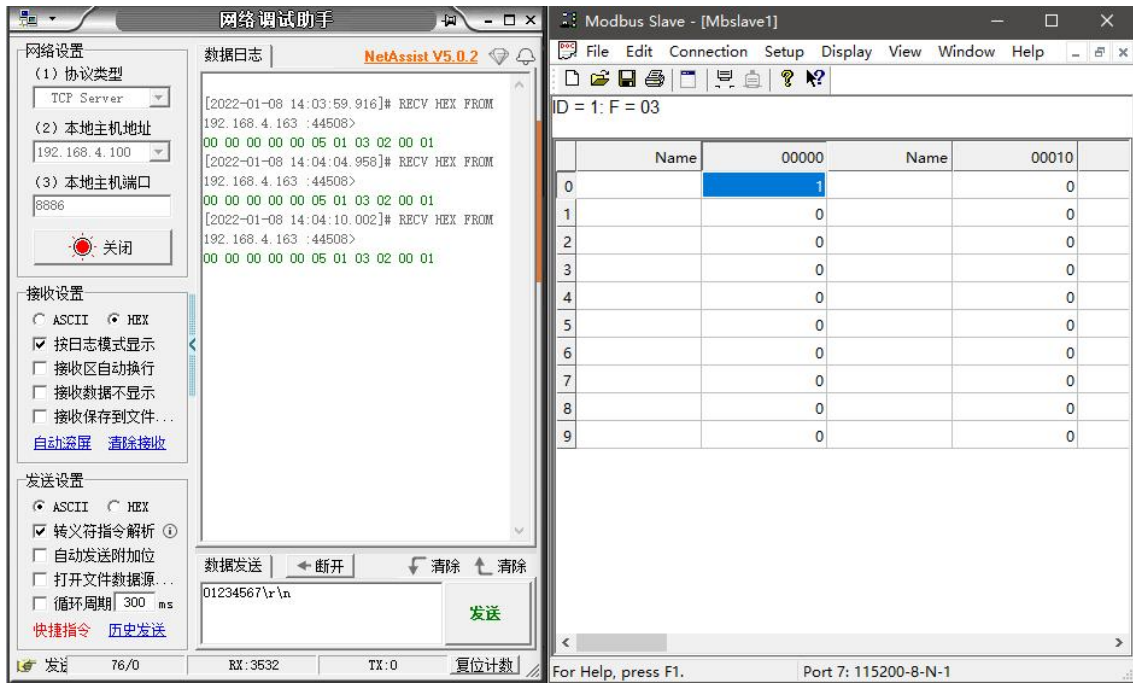

## 5.5 Firmware upgrade

Users can upgrade the firmware of the device through the "亿佰特网络配置工具".

### 5.5.1 UDP upgrade

Step 1: Open the "亿佰特网络配置工具", and select "Device Upgrade Assistant" under the "Menu" option;



Step 2: Select the firmware to be used, which needs to be obtained from the "Related Downloads" of the corresponding product details on the official website ([www.cdebyte.com](http://www.cdebyte.com)). The demo firmware is not provided on the official website.

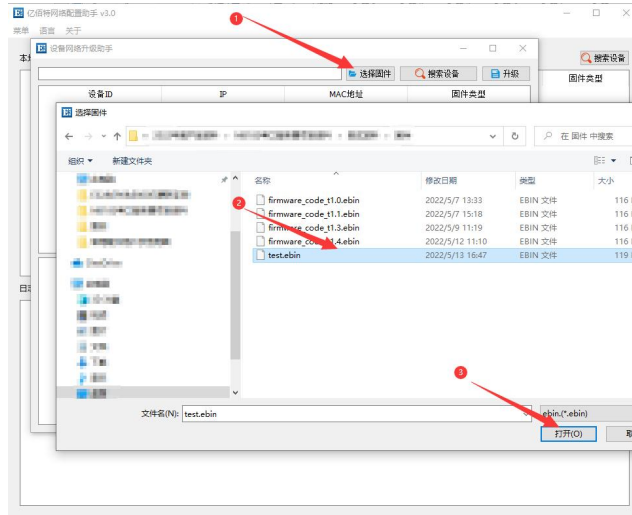

Step 3: Click "Search Device", the device list will display the currently found device, click "Stop Search".

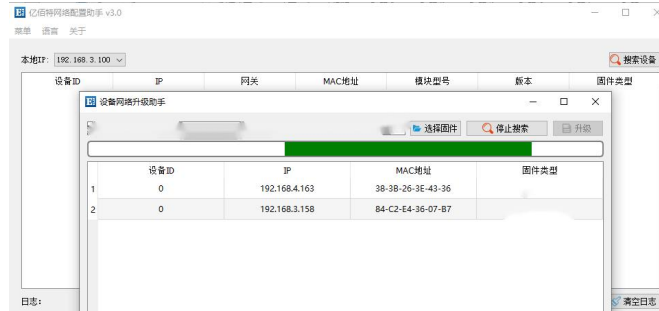

After selecting the device to be upgraded, click Start to upgrade, and wait for the host computer to display that the upgrade is complete.

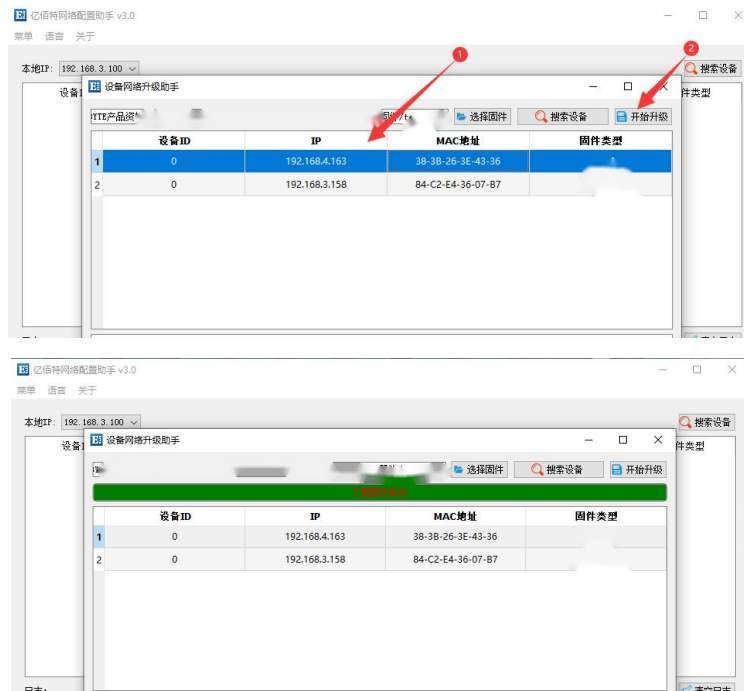

### 5.5.2 Serial upgrade

Only channel 1 (that is, serial port 1, which can use RS232 interface/RS485 interface/RS422 interface) supports the use of serial port for upgrading. When the network upgrade fails or the network environment is complicated, it is recommended to use the serial port for upgrading;

Step 1: Make sure the device is powered off and connect to serial port 1 correctly;

Step 2: Open the "亿佰特网络配置工具", select "Serial Port Upgrade Assistant" under the "Menu" option, select the corresponding serial port and click "Open Serial Port";

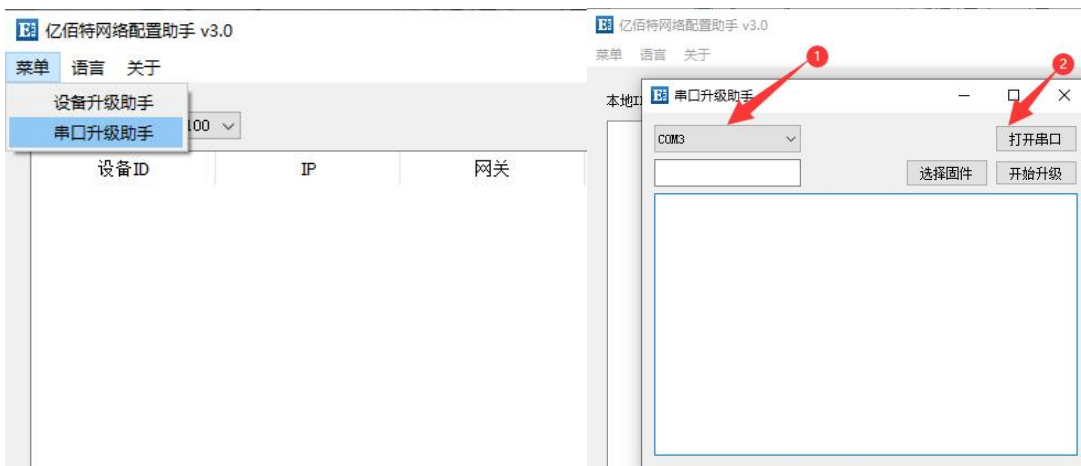

Step 3: Select the firmware to be used, which needs to be obtained from the "Related Downloads" of the corresponding product details on the official website ([www.cdebyte.com](http://www.cdebyte.com)). The demo firmware is not provided on the official website;

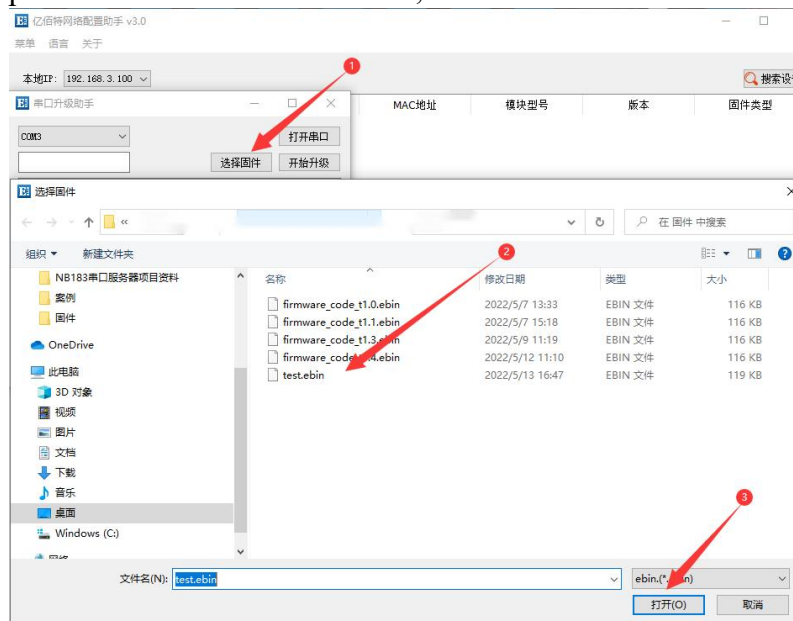

Step 4: Click "Start Upgrading", press the button Reload of NB124 and then turn on the power of the device, wait for the firmware upgrade to complete, click "Cancel" to end the serial port

upgrade;

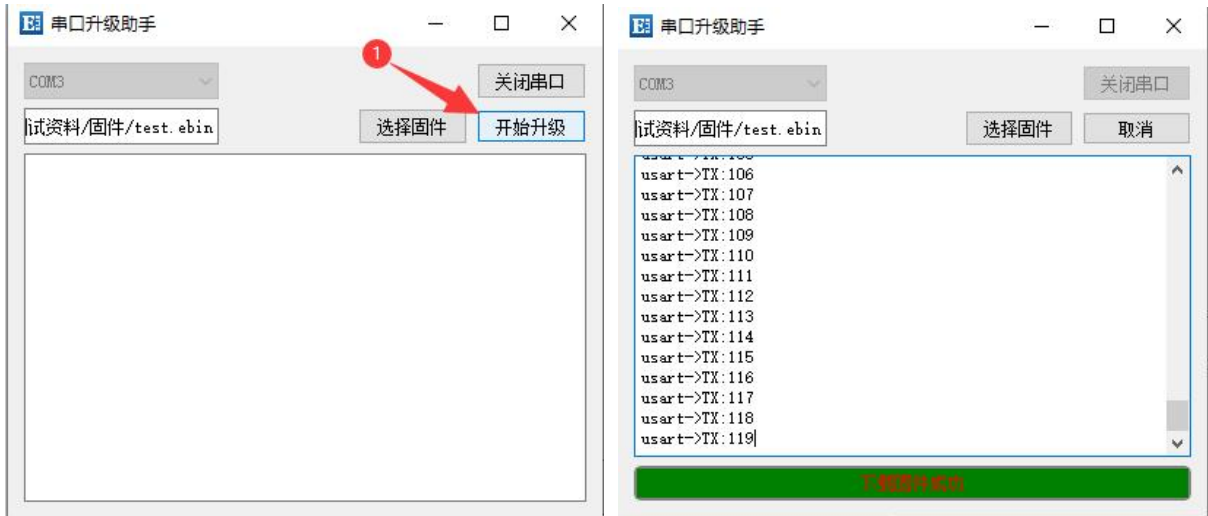

The final interpretation right belongs to Chengdu Ebyte Electronic Technology Co., Ltd.

## Revision History

Version	Revision date	Revision instruction	Maintainer
1.0	2022-11-14	Initial version	LYL

## About Us

Technical support: [support@cdebyte.com](mailto:support@cdebyte.com)

Documents and RF Setting download link: <https://www.cdebyte.com>

Thank you for using Ebyte products! Please contact us with any questions or suggestions: [info@cdebyte.com](mailto:info@cdebyte.com)

-----  
Official hotline:028-61399028

Web: <https://www.cdebyte.com>

Address: B5 Mould Park, 199# Xiqu Ave, High-tech District, Sichuan, China



**Chengdu Ebyte Electronic Technology Co.,Ltd.**