



# **E220-400R30D User Manual**

**433/470MHz 30dBm New Lora Wireless Module**



## Contents

Disclaimer .....	3
1 Introduction .....	4
1.1 Brief Introduction .....	3
1.2 Features .....	4
1.3 Application .....	4
2 Specification and parameter .....	4
2.1 Limit parameter .....	4
2.2 Operating parameter .....	5
3 Size and pin definition .....	6
4 Recommended wire diagram .....	7
5 Detailed Functions .....	8
5.1 Fixed-point launch .....	8
5.2 Broadcast launch .....	8
5.3 Broadcast address .....	9
5.4 Monitor address .....	9
5.5 STB details .....	9
5.5.1 Instructions during configuration .....	9
5.5.2 Wireless transmit instruction .....	9
6 Operating mode .....	9
7 Factory default parameters .....	10
8 Configuration instructions on computer .....	10
9 Hardware design .....	11
10 FQA .....	14
10.1 The transmission distance is not ideal .....	错误! 未定义书签。
10.2 Module is easy to be damaged .....	错误! 未定义书签。
10.3 BER(Bit Error Rate) is high .....	错误! 未定义书签。
11 Production guidance .....	14
11.1 Reflow soldering temperature .....	15
11.2 Reflow soldering curve .....	15



12 E22 series .....	15
13 Antenna recommendation .....	15
14 Package for bulk order .....	17
Revision history .....	17
About us .....	17

## 1.1 Brief Introduction

The E220-400R30D uses a new generation of LoRa spread-band technology based on the RS485 module designed for the LLCC68 chip scheme with a variety of transmission modes. It operates in the (410.125 to 493.125MHz) frequency (default 433.125MHz) and supports DC 5.0 power supply. Factory equipped with a dedicated power-up machine, power-up automatic identification. Support transmission, fixed-point transmission mode, can be paired with the E220 same frequency series for low-power applications.



### Disclaimer

EBYTE reserves all rights to this document and the information contained herein. Products, names, logos and designs described herein may in whole or in part be subject to intellectual property rights. Reproduction, use, modification or disclosure to third parties of this document or any part thereof without the express permission of EBYTE is strictly prohibited.

The information contained herein is provided “as is” and EBYTE assumes no liability for the use of the information. No warranty, either express or implied, is given, including but not limited, with respect to the accuracy, correctness, reliability and fitness for a particular purpose of the information. This document may be revised by EBYTE at any time. For most recent documents, visit [www.ebyte.com](http://www.ebyte.com).

# 1 Introduction

## 1.2 Features

- Based on LLCC68, the new LoRa amplification modulation technology, longer communication distance and stronger anti-jamming capability.
- Support users to set their own communication keys, and can not be read, greatly improve the confidentiality of user data;
- Support LBT function, listening to channel environment noise before sending the data, can greatly improve the module in the harsh environment of communication success rate;
- Support RSSI signal strength indication function, used to evaluate signal quality, improve communication network, measure the distance;
- Support fixed-point transmission, broadcast transmission, channel monitoring;
- Support the global license-free ISM 433MHz frequency and 470MHz meter reading frequency;
- When powered down, the parameters will be saved automatically, and the module will work according to the set parameters after re-powering up;
- Efficient gate-keeper design, in the event of an exception, the module will restart automatically and continue to work in accordance with the previous parameter settings;
- Supports data transfer rates from 2.4k to 62.5kbps;
- Industrial grade standard design, support -40 ~ 85 °C for working over a long time;
- SMA antenna interface.

## 1.3 Application

- Home security alarm and remote keyless entry;
- Smart homes and industrial sensors;
- Wireless alarm security system;
- Building automation solutions;
- Wireless industrial-grade remote control;
- Advanced Meter Reading Architecture(AMI);
- Automotive industry applications.

# 2 Specification and parameter

## 2.1 Limit parameter

Main parameter	Performance		Remark
	Min	Max	

Power supply (V)	0	5.5	Voltage over 5.5V will cause permanent damage to module
Blocking power (dBm)	-	10	Chances of burn is slim when modules are used in short distance
Operating temperature (°C)	-40	+85	Industrial grade

## 2.2 Operating parameter

Main parameter		Performance			Remark
		Min	Type	Max	
Operating voltage (V)		4.5	5.0	5.5	≥5.5 V ensures output power
Communication level (V)		-	-	-	For 5V TTL, it may be at risk of burning down
Operating temperature (°C)		-40	-	85	Industrial grade
Operating frequency (MHz)		410.125	-	493.125	Support ISM band
Power Consumption	TX current (mA)	-	630	-	Instant power consumption@30dBm
	RX current (mA)	-	19	-	-
	Sleep current (μA)	-	-	-	Low power consumption is not supported
Max TX power (dBm)		29.5	30.0	30.5	-
Receiving sensitivity (dBm)		-	-129	-	-124dbm,BW_L=125kHz,SF = 7,LORATM; -129dbm,BW_L=125kHz,SF = 9,LORATM; -121dbm,BW_L=250kHz,SF = 7,LORATM; -129dbm,BW_L=250kHz,SF = 10,LORATM; -117dbm,BW_L=500kHz,SF = 7,LORATM; -127dbm,BW_L=500kHz,SF = 11,LORATM;
Air data rate (bps)		2.4k	2.4k	62.5k	Controlled via user's programming

Main parameter	Description	Remark
Reference distance	10km	Test condition: clear and open area, antenna gain: 5dBi, antenna height: 2.5m, air data rate: 250 kbps
Launch length	200 Byte	The subcontract 32/64/128/200 bytes can be sent by instruct settings
Cache capacity	400 Byte	-
Modulation	LoRa	New generation of LoRa modulation technology

Communication Interface	485 interface	485 level
Encapsulate	Pin	-
Interface	PH2.0	Space 2.0mm with reserved 2.54mm hole
Outer size	26*48mm	-
RF interface	SMA-K	The equivalent impedance is about 50 degrees

### 3 Size and pin definition

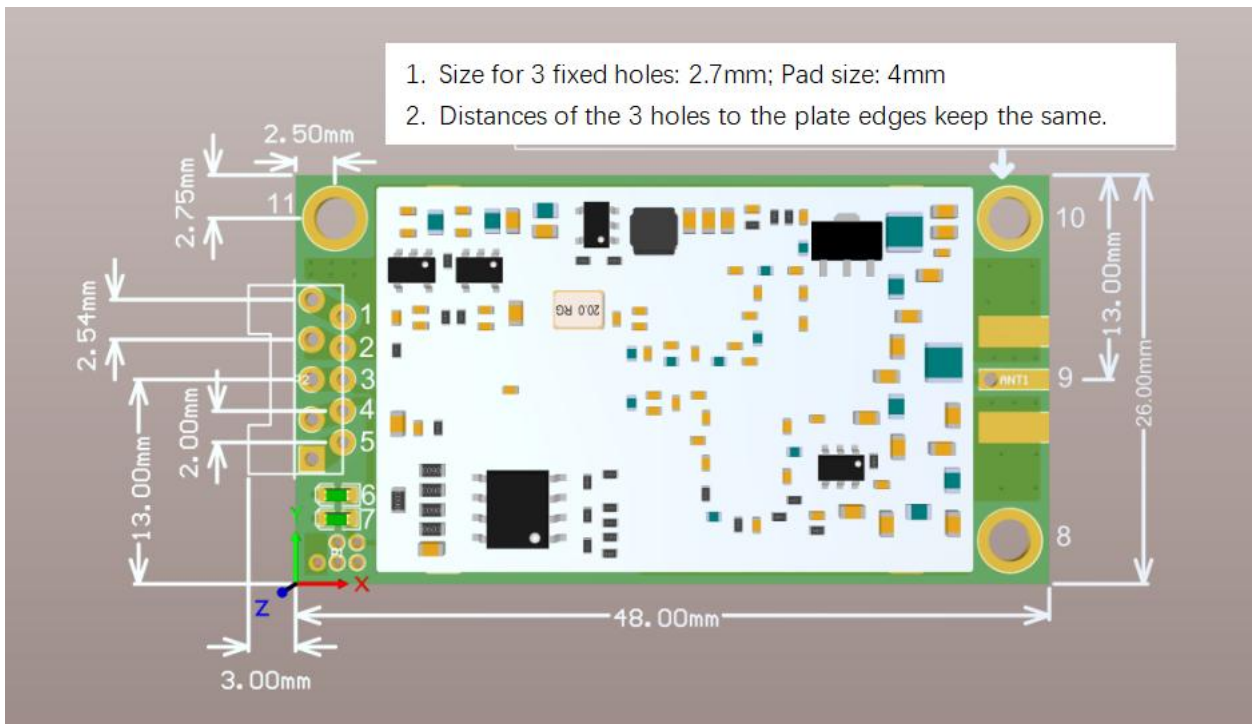

Pin No.	Item	Direction	Description
1	VCC	Input	Module power supply is referenced, voltage range: 4.5 to 5.5V DC
2	GND	Input	Module ground line
3	485A	Input/Output	A of the RS485 interface, A of the external RS485 device
4	485B	Input/Output	B of the RS485 interface, B of the external RS485 device
5	STB	Output	Low when idle, high for configuration and sending&receiving
6	Sending Light	-	Green, the light flashes when data is sent
7	Receiving Light	-	Blue, the light flashes when data is sent
8	Fixed holes	-	Fixing hole (diameter 2.7mm)
9	RF interface	-	SMA-K, equivalent impedance is about 50 s
10	Fixed holes	-	Fixing hole (diameter 2.7mm)
11	Fixed holes	-	Fixing hole (diameter 2.7mm)

## 4 Recommended wire diagram

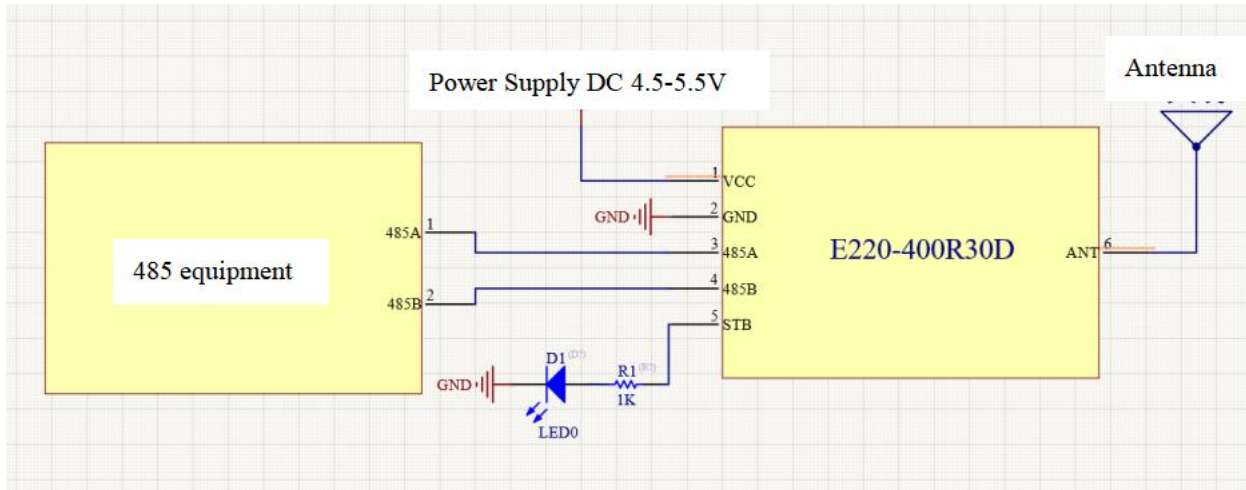

No.	Description of the module's brief connection to the 485 device
1	RS485 interface A, external RS485 device A; RS485 interface B, external RS485 device B
2	The STB pin can be connected with an indicator (note the series flow limit resistance) as an indication that the module is working properly; You can also not answer.
3	Direct access to the 433MHz/470MHz antenna at the RF interface.



## 5 Detailed Functions

### 5.1 Fixed-point launch

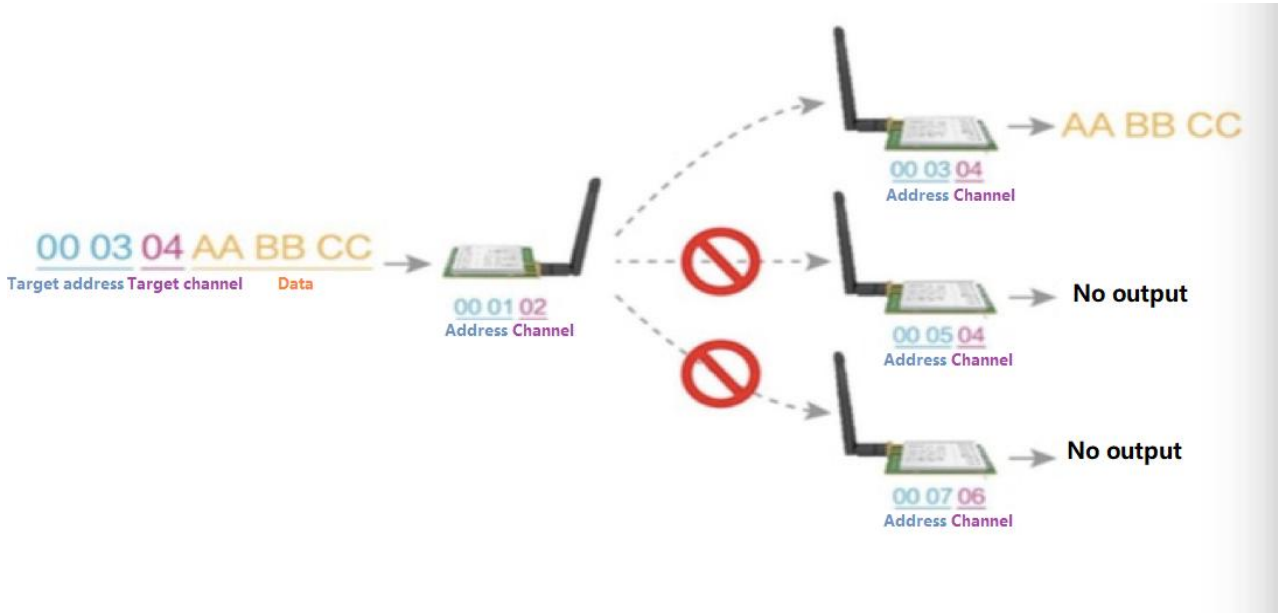

### 5.2 Broadcast launch

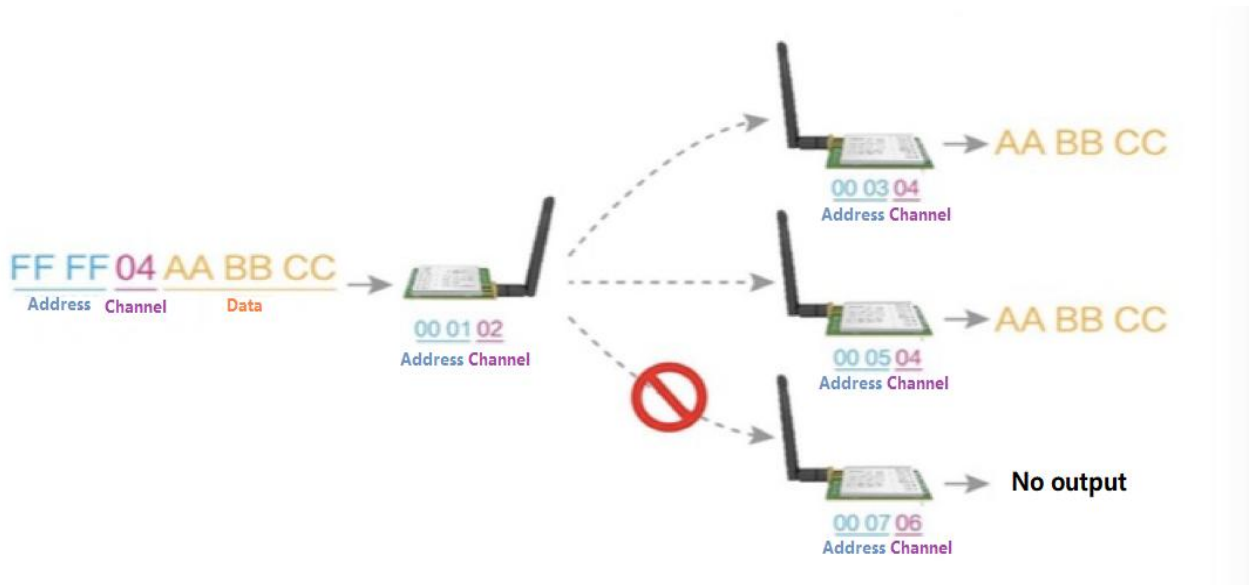

## 5.3 Broadcast address

- For example: Set the address of module A as 0xFFFF or 0x0000, and the channel as 0x04;
- When module is the transmitter (transparent transmission), all modules under channel 0x04 will receive the data, the purpose of broadcast is realized..

## 5.4 Monitor address

- For example: Set the address of module A as 0xFFFF or 0x0000, and the channel as 0x04;
- When module A is the receiver, it can receive the data sent from all modules under channel 0x04, the purpose of monitor is realized.

## 5.5 STB details

- STB is used for wireless sending &receiving buffer instructions and power-on configuration instructions.
- STB indicates whether the module with data that has not been transmitted by wireless, or whether the received wireless data that has not been totally transmitted through the serial port, or whether the module is powered up during the configuration process.

### 5.5.1 Instructions during configuration

- The module is powered will be in configuration mode on automatically, at which stage STB is high until the configuration mode is exited

### 5.5.2 Wireless transmit instruction

- The wireless is in the send state and the sending light will light up.
- The wireless is in the receive state and the receive light will be lit.

## 6 Operating mode

Mode	Mode introduction	Note
General mode	Sending and receiving wireless datas	
Wake-up mode	WOR as the sender, used with E220 serial series modules	

## 7 Factory default parameters

Model							
Module type	Frequency	Address	Channel	Air rate	Porter rate	Serial format	Transmit power
E22-400R30D	433.125M Hz	0x0000	0x17	2.4kbps	9600	8N1	30dbm

## 8 Configuration instructions on computer

The below picture is the E220-400R30D configuration of the upper computer display interface, the user will be on the module within 5 seconds after the power-up click read parameters or click on the reading parameters within 5 seconds after the module re-powered, users can enter the configuration mode, parameters in the upper computer for rapid configuration and reading. After the configuration is complete, click to close the serial port or turn off the upper computer waiting for ten seconds, the module will enter the normal working state automatically.

E220\_V1.1

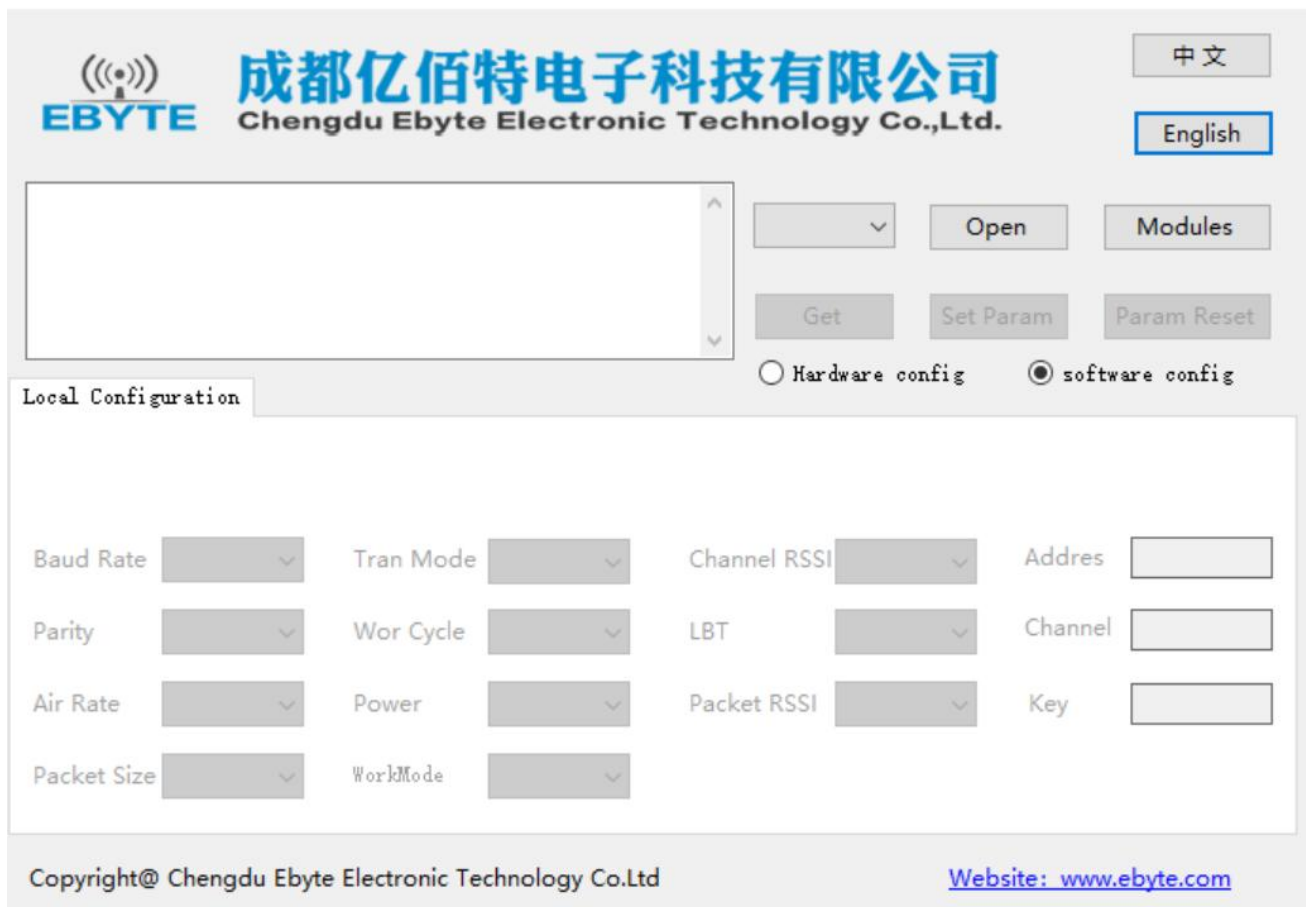

- In the configuration of the upper computer, the module address, frequency channel, network ID, and key are

deciture display mode;  
 Network address: 0 to 65535  
 Frequency channels: 0 to 83  
 Keys: 0 to 65535

## 9 Register read and write control

### 9.1 Instruction format

In configuration mode, the supported command list is as follows (when setting, only 9600, 8N1 format is supported):

No	Command Format	Description
1	Set Register	Instructions: C0 + starting address + length + parameter Response: C1 + starting address + Length + parameter Example 1: The configuration channel is 0x09 Command start address length parameter Send to: C0 04 01 09 Return: C1 04 01 09 Example 2: Also configure the module address (0x1234), serial port (9600 8N1), air speed (2.4K) Send to: C0 00 03 12 34 62 Return: C1 00 03 12 34 62
2	Read Register	Instructions: C0 + starting address + length Response: C1 + starting address + Length + parameter Example 1: Read the channel Command start address length parameter Send to: C0 04 01 Return: C1 04 01 09 Example 2: Read the module address, serial port, and empty speed simultaneously Send to: C0 00 03 Return: C1 00 03 12 34 62
3	Set Temporary Register	Instructions: C2 + starting address + length + parameter Response: C1 + starting address + Length + parameter Example 1: The configuration channel is 0x09 Command start address length parameter Send to: C0 04 01 09 Return: C1 04 01 09 Example 2: Also configure the module address (0x1234), serial port (9600 8N1), air speed (2.4K) Send to: C0 00 03 12 34 62 Return: C1 00 03 12 34 62
4	Wrong Format	Wrong format responds FF FF FF

### 9.2 Register Description

Address	Read or Write	Name	Description	Remark
00H	Read/Write	ADDH	ADDH (default 0)	High byte and low byte of module address; Note: When the module address is equal to FFFF,

01H	Read/Write	ADDL	ADDL (default 0)			it can be used as the broadcast and monitor address, that is: the module will not perform address filtering at this time			
02H	Read/Write	REG0	7	6	5	UART Serial Port Rate (bps)	<p>For the two modules that communicate with each other, the serial port baud rate can be different, and the verification method can also be different;</p> <p>When continuously transmitting large data packets, users need to consider the data congestion caused by the same baud rate, and may even be lost;</p> <p>It is generally recommended that the baud rate of the two communication parties be the same.</p>		
			0	0	0	UART Rate is 1200			
			0	0	1	UART Rate is 2400			
			0	1	0	UART Rate is 4800			
			0	1	1	UART Rate is 9600 (default)			
			1	0	0	UART Rate is 19200			
			1	0	1	UART Rate is 38400			
			1	1	0	UART Rate is 57600			
			1	1	1	UART Rate is 115200			
		4	3	Serial Parity Bit		The serial port mode of the communication parties can be different;			
		0	0	8N1 (default)					
		0	1	8O1					
		1	0	8E1					
		1	1	8N1 (equal to 00)		The air rate of both parties must be the same; The higher the air rate, the smaller the delay and the shorter the transmission distance.			
		2	1	0	Air Data Rate (bps)				
		0	0	0	Air Data Rate 2.4k				
		0	0	1	Air Data Rate 2.4k				
		0	1	0	Air Data Rate 2.4k (default)				
0	1	1	Air Data Rate 4.8k						
1	0	0	Air Data Rate 9.6k						
1	0	1	Air Data Rate 19.2k						
1	1	0	Air Data Rate 38.4k						
1	1	1	Air Data Rate 62.5k						
03H	Read/Write	REG1	7	6	Sub-Packet Setting		The data sent by the user is less than the sub-packet length, and the serial port output of the receiving end appears as an uninterrupted continuous output;		
			0	0	200 bytes (default)				
			0	1	128 bytes				
			1	0	64 bytes		The data sent by the user is larger than the packet length, and the serial port of the receiving end will be output in packets.		
			1	1	32 bytes				
			5	RSSI Ambient noise enable					<p>Enable instruction (subcontract setting, transmit power as default parameters, Configuration mode): C0 03 01 20;</p> <p>After enabling, you can send commands C0 C1 C2 C3 in transmission mode or WOR sending mode to read registers;</p> <p>Register 0x00: Current environmental noise RSSI;</p> <p>Register 0X01: RSSI when receiving data last time</p> <p>(The current channel noise is: dBm = - (256 - RSSI) );</p> <p>Instruction format: C0 C1 C2 C3+start address+read length;</p> <p>Return: C1 + address + read length + read valid value; for example: send C0 C1 C2 C3 00 01</p> <p>Return C1 00 01 RSSI (address can only start from 00)</p>
			0	Disable (Default)					
1	Enable								

			4	3	2	Reserve		
			1	0	Transmitting Power		The relationship between power and current is non-linear, and the power supply has the highest efficiency at maximum power;  The current will not decrease in the same proportion as the power decreases.	
			0	0	30dBm (default)			
			0	1	27dBm			
			1	0	24dBm			
			1	1	21dBm			
04H	Read/Write	REG2	Channel Control (CH) 0-83 represents a total of 84 channels				Actual frequency = 410.125 + CH *1M	
05H	Read/Write	REG3	7	Enable RSSI Byte			After being enabled, the module receives wireless data and outputs it through the serial port TXD, followed by an RSSI strength byte.	
			0	Disable (Default)				
			1	Enable				
			6	Transmission Method			During fixed transmission, the module will recognize the first three bytes of serial data as: address high + address low + channel, and use it as a wireless transmission target.	
			0	Transparent transmission mode (default)				
			1	Fixed transmission mode				
			5	Reserve				
			4	LBT Enable			After enabling, monitoring will be conducted before wireless data transmission, which can avoid interference to a certain extent, but may cause data delay;	
			0	Disable (Default)				
			1	Enable			The maximum stay time of LBT is 2 seconds, and it will be issued forcibly when it reaches 2 seconds.	
			3	Work Pattern			General mode can only be wireless transmission and receiving; In the wake-up mode, the module can only be used as the WOR sender, and it needs to be used with the E220 serial port series module;	
			0	General mode (by default)				
			1	Wake up mode				
			2	1	0	WOR Cycle		Only valid for mode 1;
			0	0	0	500ms		
			0	0	1	1000ms		Cycle T= (1+WOR)*500ms, the maximum is 4000ms, the minimum is 500ms;
0	1	0	1500ms					
0	1	1	2000ms (Default)		The longer the WOR monitoring interval period, the lower the average power consumption, but the greater the data delay;			
1	0	0	2500ms					
1	0	1	3000ms		Both sender and receiver must agree (very important)			
1	1	0	3500ms					
1	1	1	4000ms					
06H	Write	CRYPT_H	Key high byte (default 0)					
07H	Write	CRYPT_L	Key low byte (default 0)					

## 10 Hardware design

- It is recommended to use DC regulatory power supply to power the module, the power ripple coefficient is as small as possible, the module needs to be reliably grounded;
- Please notice that the correct connection of the power supply positive and negative poles, such as back-linking, may cause permanent damage to the module;
- Please check the power supply to ensure that between the recommended supply voltage, if the maximum value is exceeded, the module will be permanently damaged;
- Please check the stability of the power supply, the voltage can not fluctuate significantly and frequently;
- When designing power supply circuits for modules, it is often recommended to retain more than 30% of the residual amount, and the whole machine is good for long-term stable operation;
- The module should be kept as far away as possible from the power supply, transformers, high-frequency wiring and other parts of the electromagnetic interference;
- High-frequency digital wiring, high-frequency analog wiring, power cable must avoid the module below, if you really need to go under the module, suppose the module is welded under the Top Layer, in the module contact part of the Top Layer paved copper (all copper paved and well grounded), must be close to the module digital part and the wire in The bottom Layer;
- Assuming that the module is welded or placed on Top Layer, it is also wrong to walk freely on TheBottom Layer or other layers, which can affect the stray and reception sensitivity of the module to varying degrees;
- Assuming that there is a large electromagnetic interference around the module of the device will also greatly affect the performance of the module, with the intensity of interference recommended appropriately away from the module, if circumstances permit to do appropriate isolation and shielding;
- Assuming that there is a large electromagnetic interference around the module (high-frequency digital, high-frequency analog, power cable) will also greatly affect the performance of the module, with the intensity of interference recommended appropriately away from the module, if circumstances permit to do appropriate isolation and shielding;
- If the communication line uses a 5V level, the 1k-5.1k resistor must be connected in series (not recommended, there is still a risk of damage);
- Try to stay away from some physical layers also 2.4GHz TTL protocol, e.g. USB 3.0;
- Antenna installation structure has a great impact on module performance, it is necessary to ensure that the antenna exposed and preferably vertical upward;
- When the module is installed inside the enclosure, the antenna can be extended to the outside of the enclosure using a high-quality antenna extension cable;
- The antenna must not be installed inside the metal case, which will result in a significant reduction in transmission distance.

## 11 Production guidance

Profile Feature	Sn-Pb Assembly	Pb-Free Assembly
Solder Paste	Sn63/Pb37	Sn96.5/Ag3/Cu0.5
Preheat Temperature min (T <sub>smin</sub> )	100°C	150°C

### 11.1

Preheat temperature max (T <sub>smax</sub> )	150°C	200°C
Preheat Time (T <sub>smin</sub> to T <sub>smax</sub> )(ts)	60-120 sec	60-120 sec
Average ramp-up rate(T <sub>smax</sub> to T <sub>p</sub> )	3°C/second max	3°C/second max
Liquidous Temperature (TL)	183°C	217°C
Time (t <sub>L</sub> ) Maintained Above (TL)	60-90 sec	30-90 sec
Peak temperature (T <sub>p</sub> )	220-235°C	230-250°C
Average ramp-down rate (T <sub>p</sub> to T <sub>smax</sub> )	6°C/second max	6°C/second max
Time 25°C to peak temperature	6 minutes max	8 minutes max

## Reflow soldering temperature

### 11.2 Reflow soldering curve

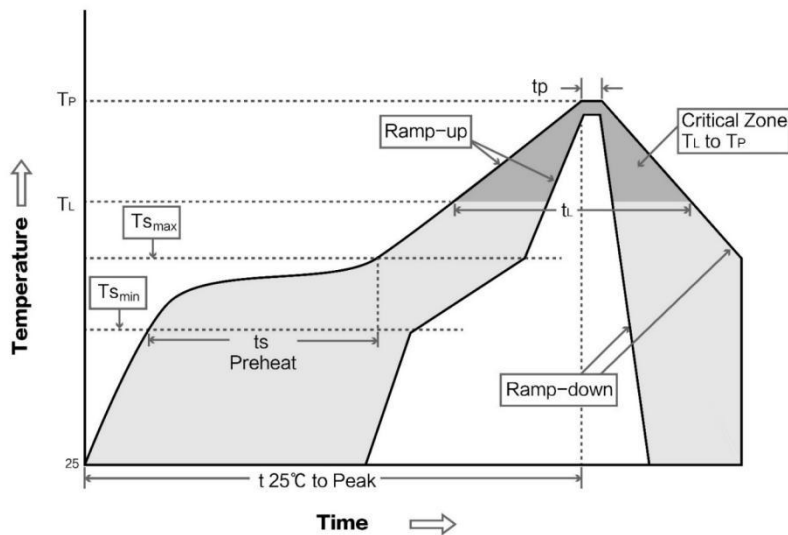

## 12 E220 series

Model No.	Core IC	Frequency (Hz)	Tx power(dBm)	Distance(km)	Package	Size (mm)	Interface
E220-400T30D	LLCC68	433/470M	30	10	DIP	26*48	RS485

## 13 Antenna recommendation

The antenna is an important role in the communication process. A good antenna can largely improve the communication system. Therefore, we recommend some antennas for wireless modules with excellent performance and



reasonable price.

Model No.	Type	Frequency Hz	Interface	Gain dBi	Height mm	Cable cm	Function feature
TX433-JZ-5	Rubber antenna	433M	SMA-J	2.0	52	-	Short straight & omnidirectional
TX433-JZG-6	Rubber antenna	433M	SMA-J	2.5	62	-	Short straight & omnidirectional
TX433-JW-5	Rubber antenna	433M	SMA-J	2.0	50	-	Flexible & omnidirectional
TX433-JWG-7	Rubber antenna	433M	SMA-J	2.5	75	-	Flexible & omnidirectional
TX433-JK-11	Rubber antenna	433M	SMA-J	2.5	110	-	Flexible & omnidirectional
TX433-JK-20	Rubber antenna	433M	SMA-J	3.0	210	-	Flexible & omnidirectional
TX433-XPL-100	Sucker antenna	433M	SMA-J	3.5	185	100	Small Sucker antenna & cost-effective
TX433-XP-200	Sucker antenna	433M	SMA-J	4.0	190	200	Middle sucker antenna & low consumption
TX433-XP-300	Sucker antenna	433M	SMA-J	6.0	965	300	Big sucker antenna & high gain
TX490-JZ-5	Rubber antenna	470/490M	SMA-J	2.0	50	-	Super Short straight & omnidirectional
TX490-XPL-100	Sucker antenna	470/490M	SMA-J	3.5	120	100	Small Sucker antenna & cost-effective

## 14 Package for bulk order

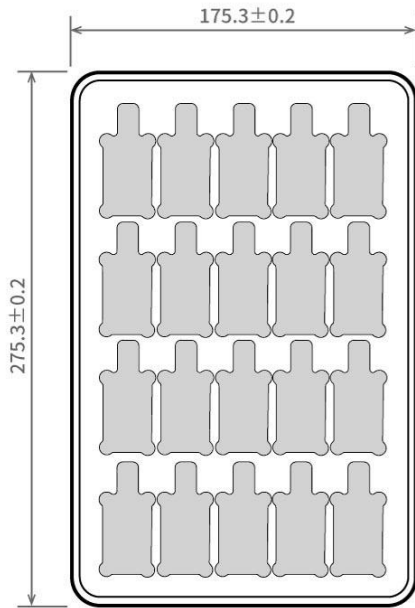

Unit: mm  
Each Layer: 20 pcs  
Each Package: 5 layers

## Revision history

Version	Date	Description	Issued by
1.00	2021-03-04	Initial version	Linson
1.1	2023-2-17	Bug fixes	Yan
1.2	2023-8-22	Bug fixes	Hao

## About us

Technical support: [support@cdebyte.com](mailto:support@cdebyte.com)

Documents and RF Setting download link: <https://www.cdebyte.com>

Thank you for using Ebyte products! Please contact us with any questions or suggestions: [info@cdebyte.com](mailto:info@cdebyte.com)

Phone: +86 028-61399028

Web: <https://www.cdebyte.com>

Address: B5 Mould Park, 199# Xiqu Ave, High-tech District, Sichuan, China



**Chengdu Ebyte Electronic Technology Co.,Ltd.**