

# QM100DY-HK

HIGH POWER SWITCHING USE  
INSULATED TYPE

## QM100DY-HK



- **IC** Collector current ..... **100A**
- **VCEX** Collector-emitter voltage ..... **600V**
- **hFE** DC current gain ..... **75**
- **Insulated Type**
- **UL Recognized**

Yellow Card No. E80276 (N)

File No. E80271

## APPLICATION

Inverters, Servo drives, DC motor controllers, NC equipment, Welders

## OUTLINE DRAWING & CIRCUIT DIAGRAM

Dimensions in mm

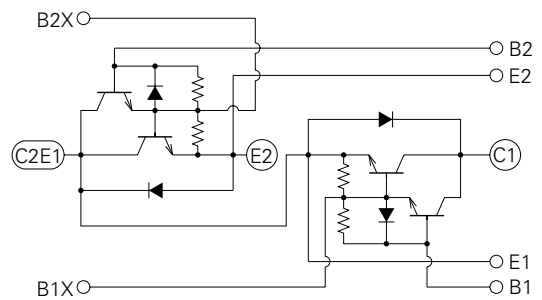
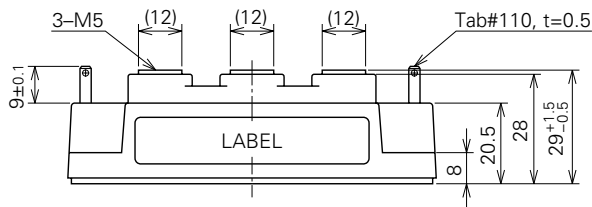
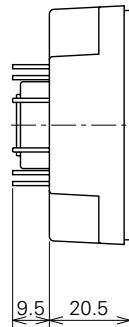
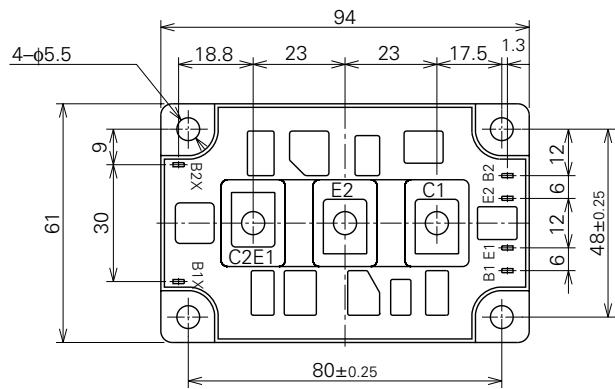

# QM100DY-HK

HIGH POWER SWITCHING USE  
INSULATED TYPE

## ABSOLUTE MAXIMUM RATINGS (T<sub>j</sub>=25°C, unless otherwise noted)

Symbol	Parameter	Conditions	Ratings	Unit
V <sub>CEX (SUS)</sub>	Collector-emitter voltage	I <sub>C</sub> =1A, V <sub>EB</sub> =2V	600	V
V <sub>CEX</sub>	Collector-emitter voltage	V <sub>EB</sub> =2V	600	V
V <sub>CBO</sub>	Collector-base voltage	Emitter open	600	V
V <sub>EBO</sub>	Emitter-base voltage	Collector open	7	V
I <sub>C</sub>	Collector current	DC	100	A
-I <sub>C</sub>	Collector reverse current	DC (forward diode current)	100	A
P <sub>C</sub>	Collector dissipation	T <sub>C</sub> =25°C	620	W
I <sub>B</sub>	Base current	DC	6	A
-I <sub>CSM</sub>	Surge collector reverse current (forward diode current)	Peak value of one cycle of 60Hz (half wave)	1000	A
T <sub>j</sub>	Junction temperature		-40~+150	°C
T <sub>stg</sub>	Storage temperature		-40~+125	°C
V <sub>iso</sub>	Isolation voltage	Charged part to case, AC for 1 minute	2500	V
—	Mounting torque	Main terminal screw M5	1.47~1.96	N·m
			15~20	kg·cm
		Mounting screw M5	1.47~1.96	N·m
			15~20	kg·cm
—	Weight	Typical value	420	g

## ELECTRICAL CHARACTERISTICS (T<sub>j</sub>=25°C, unless otherwise noted)

Symbol	Parameter	Test conditions	Limits			Unit
			Min.	Typ.	Max.	
I <sub>CEX</sub>	Collector cutoff current	V <sub>CE</sub> =600V, V <sub>EB</sub> =2V	—	—	2.0	mA
I <sub>CBO</sub>	Collector cutoff current	V <sub>CB</sub> =600V, Emitter open	—	—	2.0	mA
I <sub>EBO</sub>	Emitter cutoff current	V <sub>EB</sub> =7V	—	—	100	mA
V <sub>CE (sat)</sub>	Collector-emitter saturation voltage	I <sub>C</sub> =100A, I <sub>B</sub> =1.3A	—	—	2.0	V
V <sub>BE (sat)</sub>	Base-emitter saturation voltage		—	—	2.5	V
-V <sub>CEO</sub>	Collector-emitter reverse voltage	-I <sub>C</sub> =100A (diode forward voltage)	—	—	1.75	V
h <sub>FE</sub>	DC current gain	I <sub>C</sub> =100A, V <sub>CE</sub> =2V/5V	75/100	—	—	—
t <sub>on</sub>	Switching time	V <sub>CC</sub> =300V, I <sub>C</sub> =100A, I <sub>B1</sub> =-I <sub>B2</sub> =2A	—	—	2.0	μs
t <sub>s</sub>			—	—	12	μs
t <sub>f</sub>			—	—	3.0	μs
R <sub>th (j-c) Q</sub>	Thermal resistance (junction to case)	Transistor part (per 1/2 module)	—	—	0.2	°C/W
R <sub>th (j-c) R</sub>		Diode part (per 1/2 module)	—	—	0.65	°C/W
R <sub>th (c-f)</sub>	Contact thermal resistance (case to fin)	Conductive grease applied (per 1/2 module)	—	—	0.1	°C/W

# QM100DY-HK

HIGH POWER SWITCHING USE  
INSULATED TYPE

## PERFORMANCE CURVES

**COMMON EMITTER OUTPUT CHARACTERISTICS (TYPICAL)**

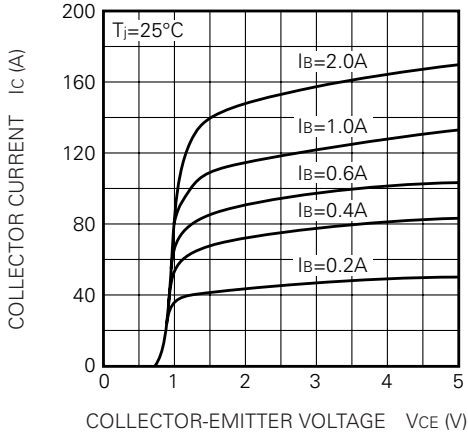

**DC CURRENT GAIN VS. COLLECTOR CURRENT (TYPICAL)**

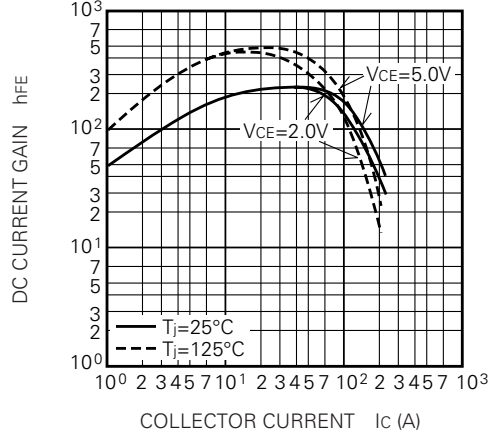

**COMMON EMITTER INPUT CHARACTERISTIC (TYPICAL)**

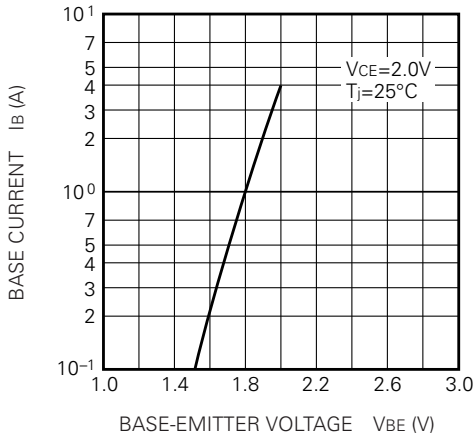

**SATURATION VOLTAGE CHARACTERISTICS (TYPICAL)**

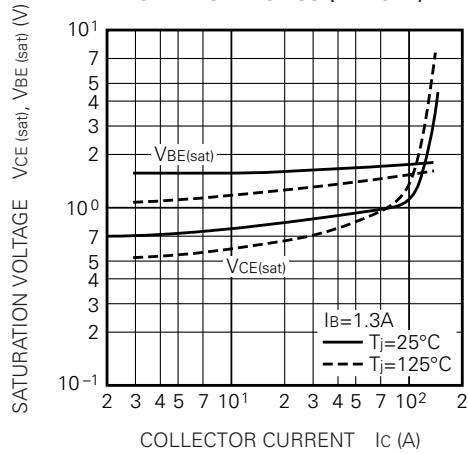

**COLLECTOR-EMITTER SATURATION VOLTAGE (TYPICAL)**

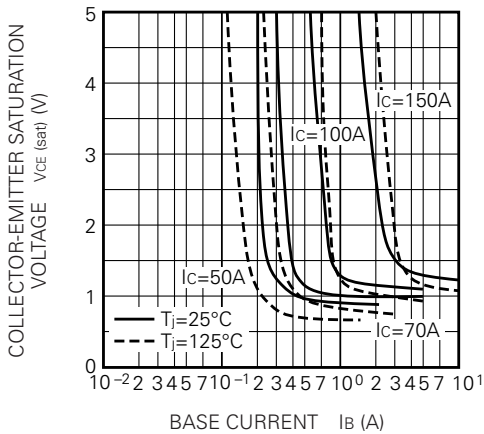

**SWITCHING TIME VS. COLLECTOR CURRENT (TYPICAL)**

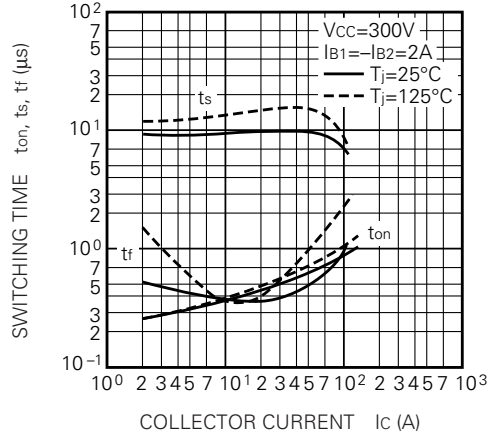

QM100DY-HK

HIGH POWER SWITCHING USE  
INSULATED TYPE

SWITCHING TIME VS. BASE CURRENT (TYPICAL)

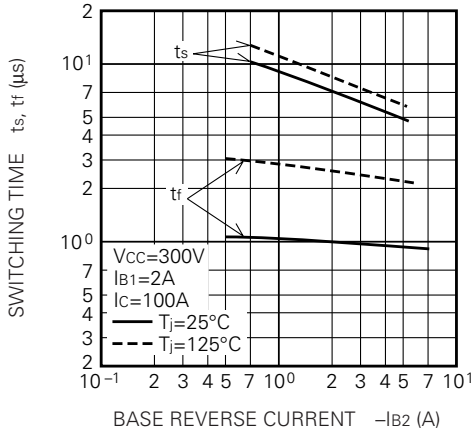

REVERSE BIAS SAFE OPERATING AREA

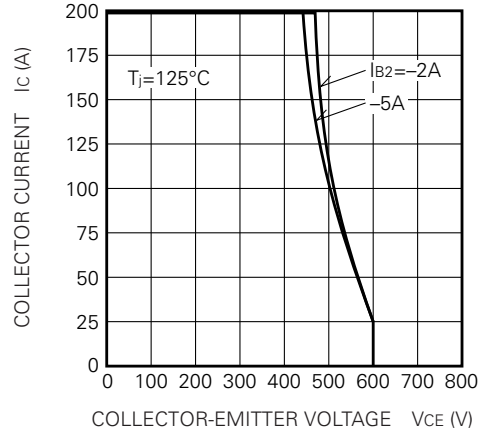

FORWARD BIAS SAFE OPERATING AREA

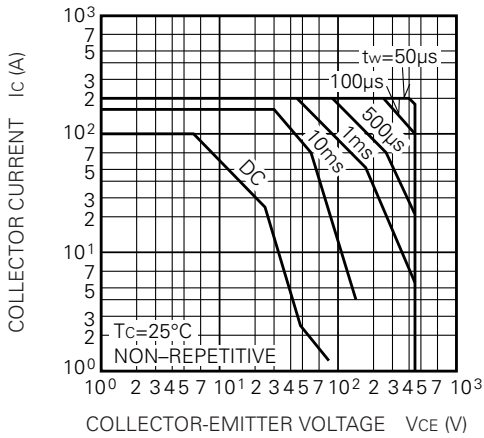

DERATING FACTOR OF F. B. S. O. A.

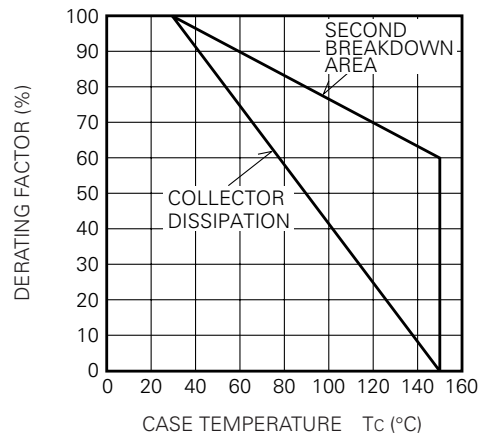

TRANSIENT THERMAL IMPEDANCE CHARACTERISTICS (TRANSISTOR)

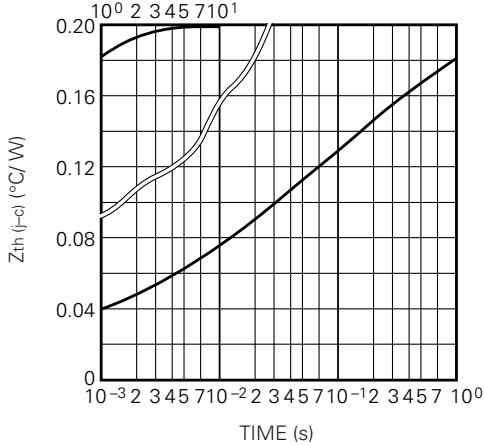

REVERSE COLLECTOR CURRENT VS. COLLECTOR-EMITTER REVERSE VOLTAGE (DIODE FORWARD CHARACTERISTICS) (TYPICAL)

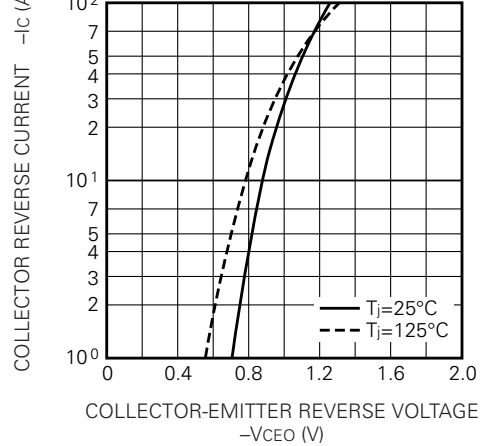

# QM100DY-HK

HIGH POWER SWITCHING USE  
INSULATED TYPE

**RATED SURGE COLLECTOR REVERSE CURRENT  
(DIODE FORWARD SURGE CURRENT)**

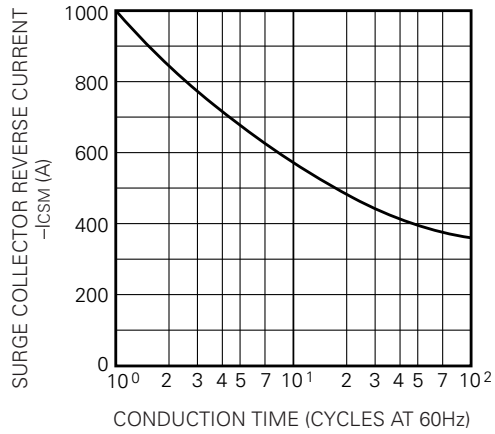

**REVERSE RECOVERY CHARACTERISTICS  
OF FREE-WHEEL DIODE (TYPICAL)**

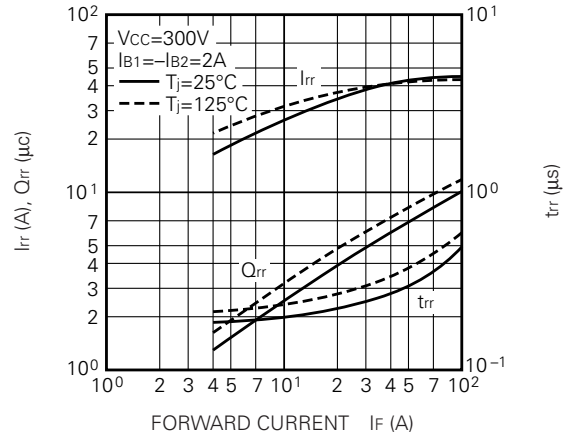

**TRANSIENT THERMAL IMPEDANCE  
CHARACTERISTICS (DIODE)**

